

# Word Processing Skills Challenge Cards

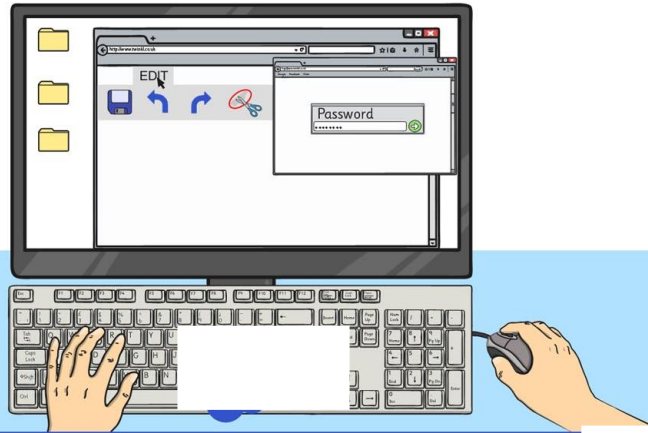

# Word Processing Skills Challenge Cards

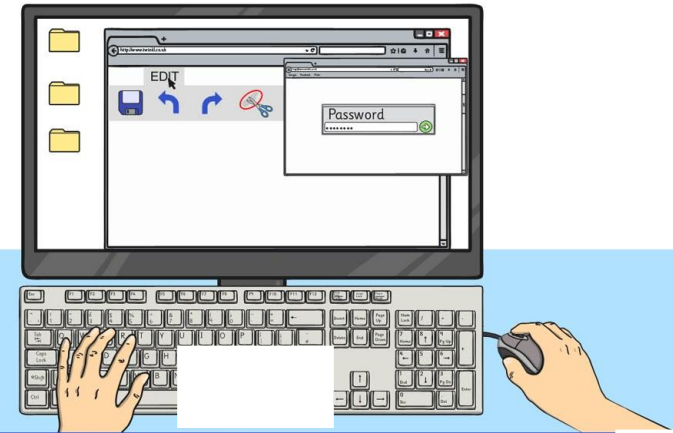

# Word Processing Skills Challenge Cards

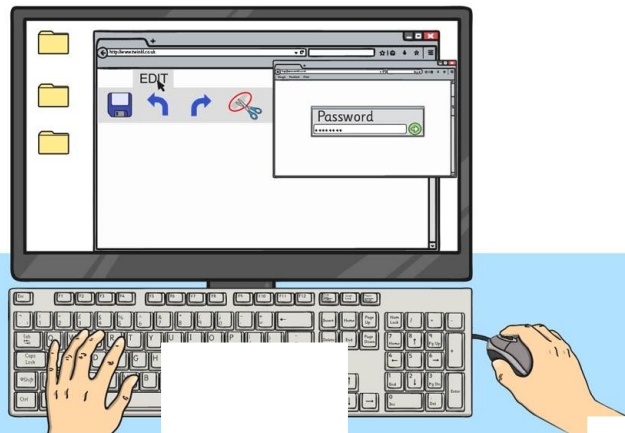

# Word Processing Skills Challenge Cards

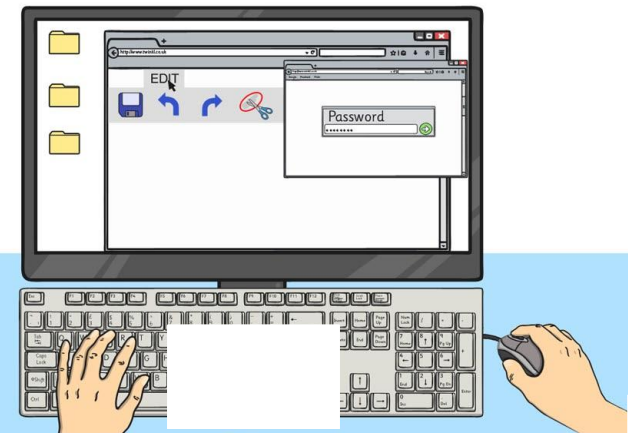

Choose a song, rhyme, book, film or TV programme with a number of words. Use it to make a password.

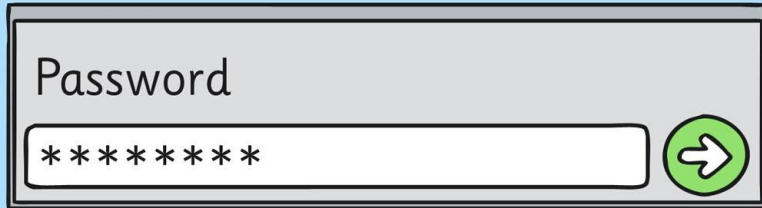

Use the Snipping Tool to make a poster to show a computer skill.

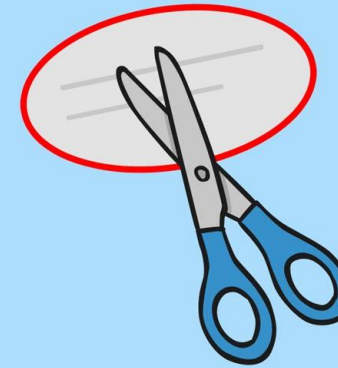

Press 'Print Screen', open Paint and paste the image into a new file. Can you crop the image?



Use the Snipping Tool to make a poster to demonstrate a skill with an application you use.



Type the alphabet with 1 hand and time how long it takes. Now try it with the other hand and see how long it takes.



Type the alphabet with 2 hands and time how long it takes. Now try it with the other hand and see how long it takes.



Change the font size to 24. Type some sentences, but press <return> or <enter> at the end of each line. Change the font to 18. What happens? Try other font sizes.

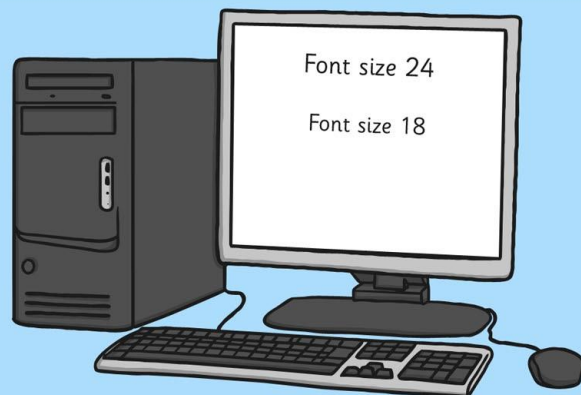

Use Caps Lock to type a few sentences, then use the change case button to reformat the case of the text. Try using just lowercase. What happens at the beginning of sentences?

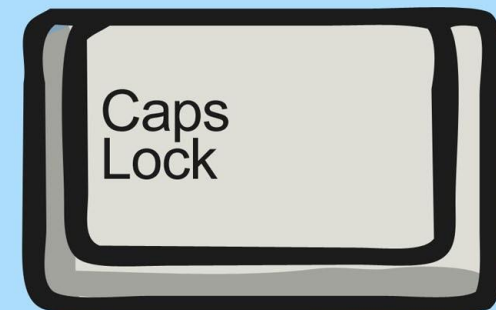

Type a letter to a new friend introducing yourself. Use the align text buttons to align your address at the top right and other features on the left.



Type a short information text about an animal. Centre your title and subtitles using the align text buttons.

Animals  
Animals can be separated into different classes. There are 6 basic classes...

Type a letter to an author of one of your favourite books, saying why you like the book. Use the align text buttons to align your address at the top right and other features on the left.



Type a short information text about a well-known person, such as a sport star, musician or singer. Centre your title and subtitles using the align text buttons.



Type a set of instructions for a favourite game. Use bullet points and or numbered points for the list of what is needed, and the instructions.



Type a set of instructions for a writing an information text. Use bullet points and or numbered points for the list of what is needed

- Bullet point 1
  - Bullet point 2
  - Bullet point 3
- 1. Number point 1
  - 2. Number point 2
  - 3. Number point 3

Type a set of instructions for a mathematical calculation. Use bullet points and or numbered points for the list of what is needed, and the instructions.



Type a set of instructions for a scientific investigation you have done. Use bullet points and or numbered points for the list of what is needed and the instructions.



Type a paragraph of 4 or 5 sentences as a description of a character, using plenty of adjectives. Using shortcuts, select all the nouns and underline and select all the adjectives and change to italics.

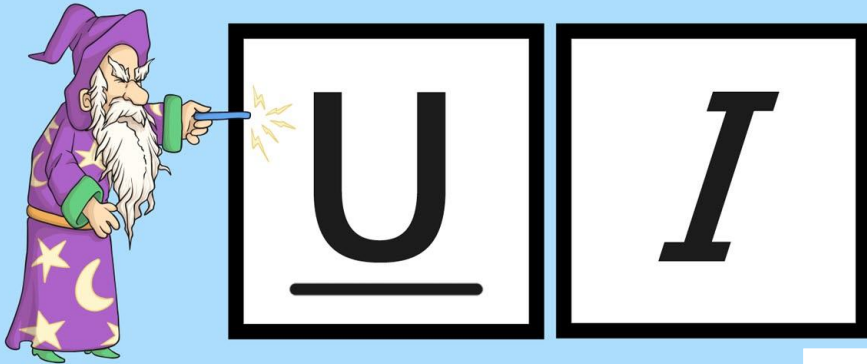

Type a list of topic words and explain their meaning. When you have completed your list, go back through and select all the topic words using <ctrl> and make bold.

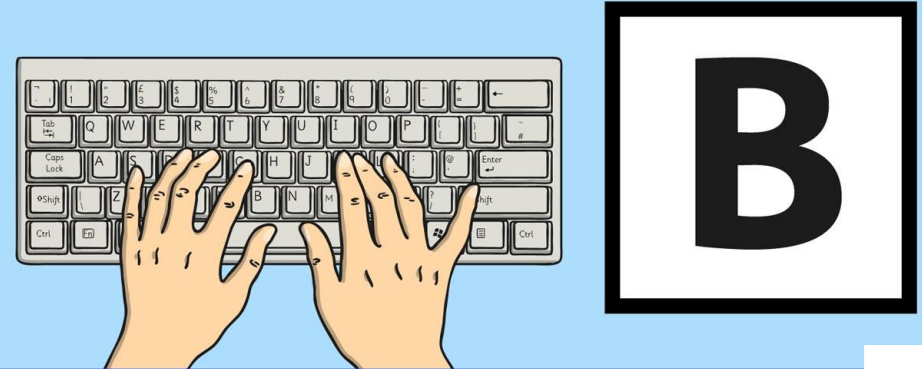

Type a paragraph of 4 or 5 sentences as a description of a setting, using plenty of adverbs. Using shortcuts, select all the verbs and underline and select all the adverbs and change to italics.



Type a poem where every other line is repeated. When you've written the poem, select all the repeating lines and change to italics. (Don't forget <ctrl>.)







Word Pr



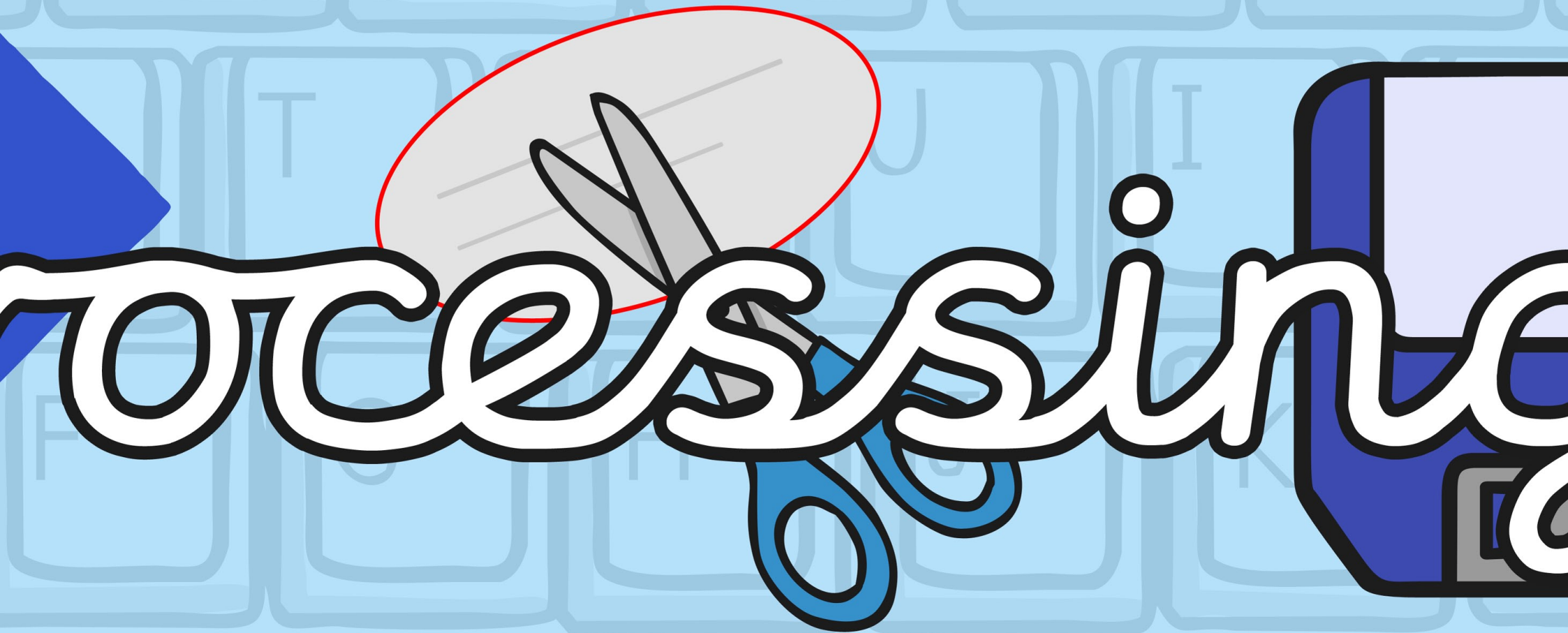



# Skills



W o r d P



# g Skills

caps lock



shift



minimise



screenshot

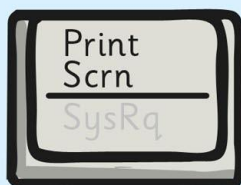

delete

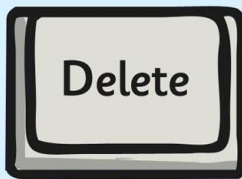

backspace

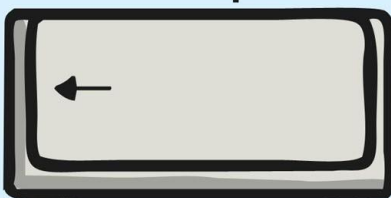

space bar

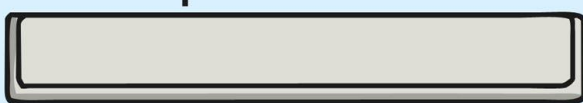

shortcut



# Word Pro

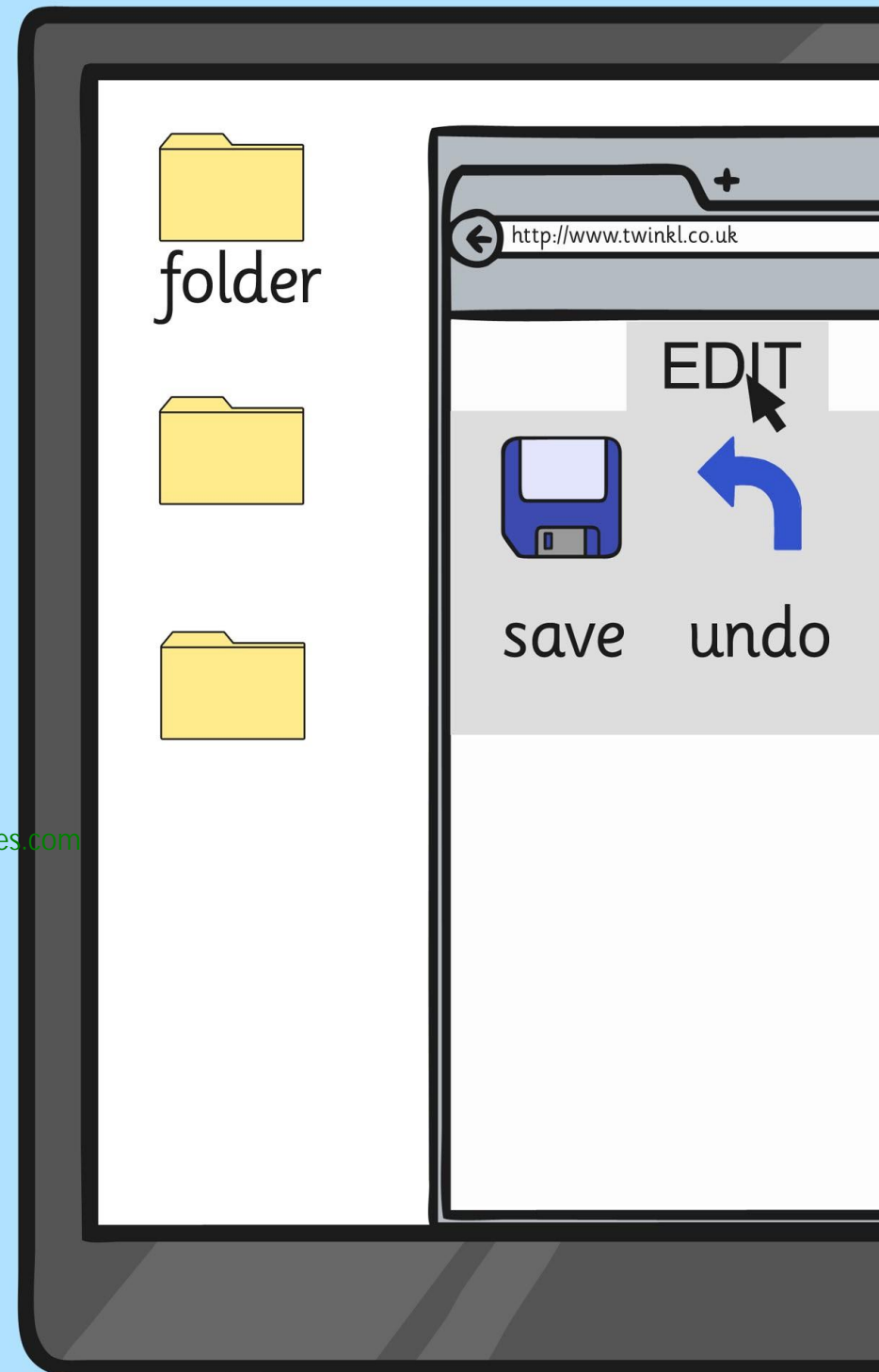

typing

# Processing Skills

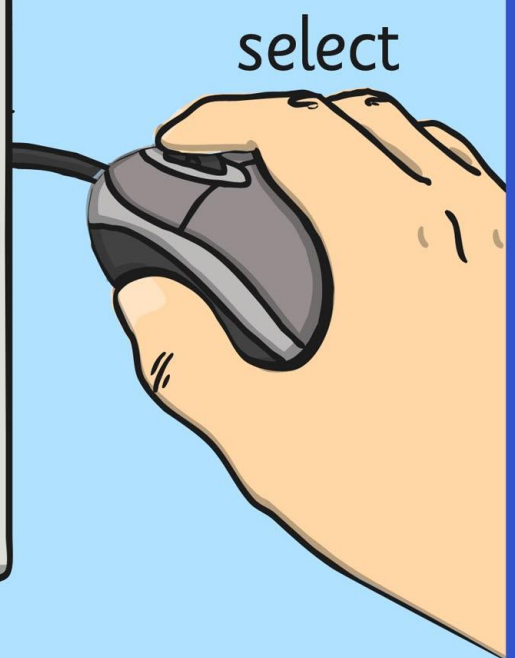
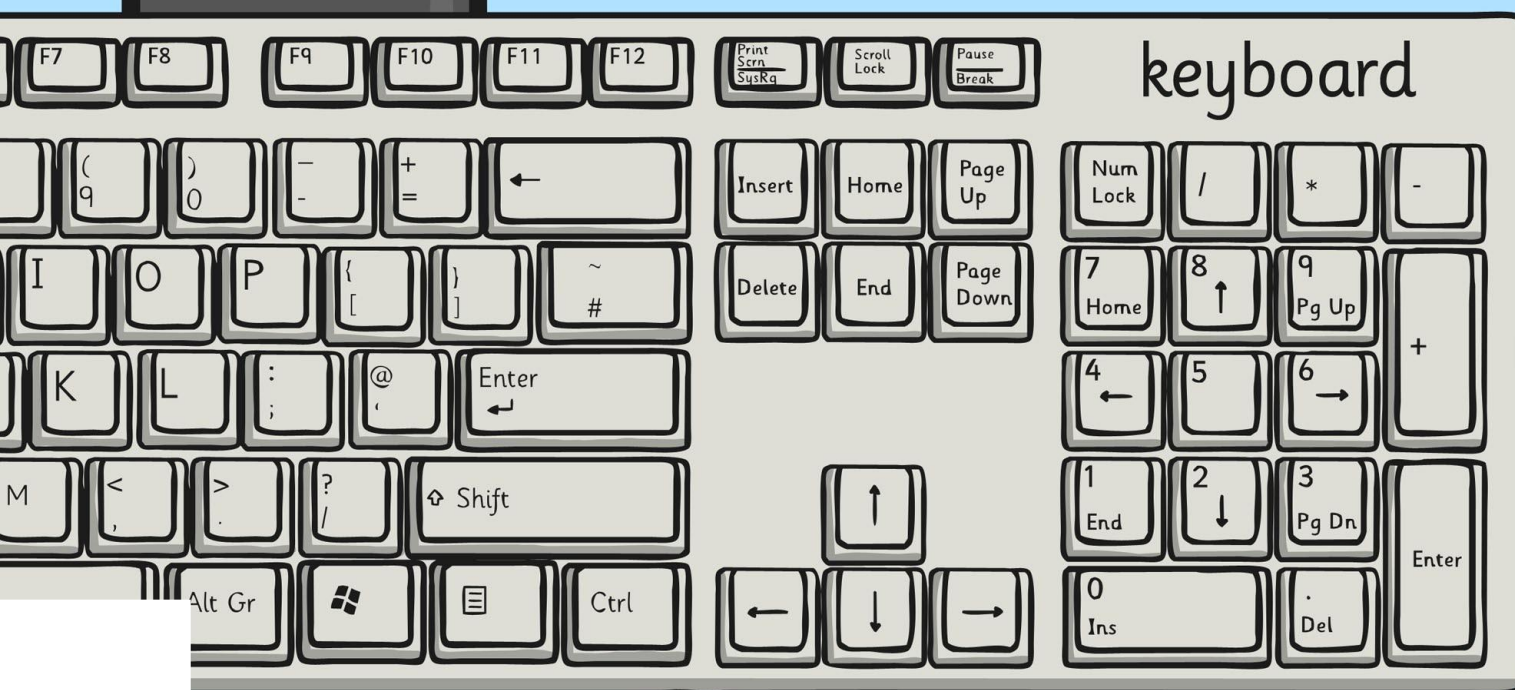
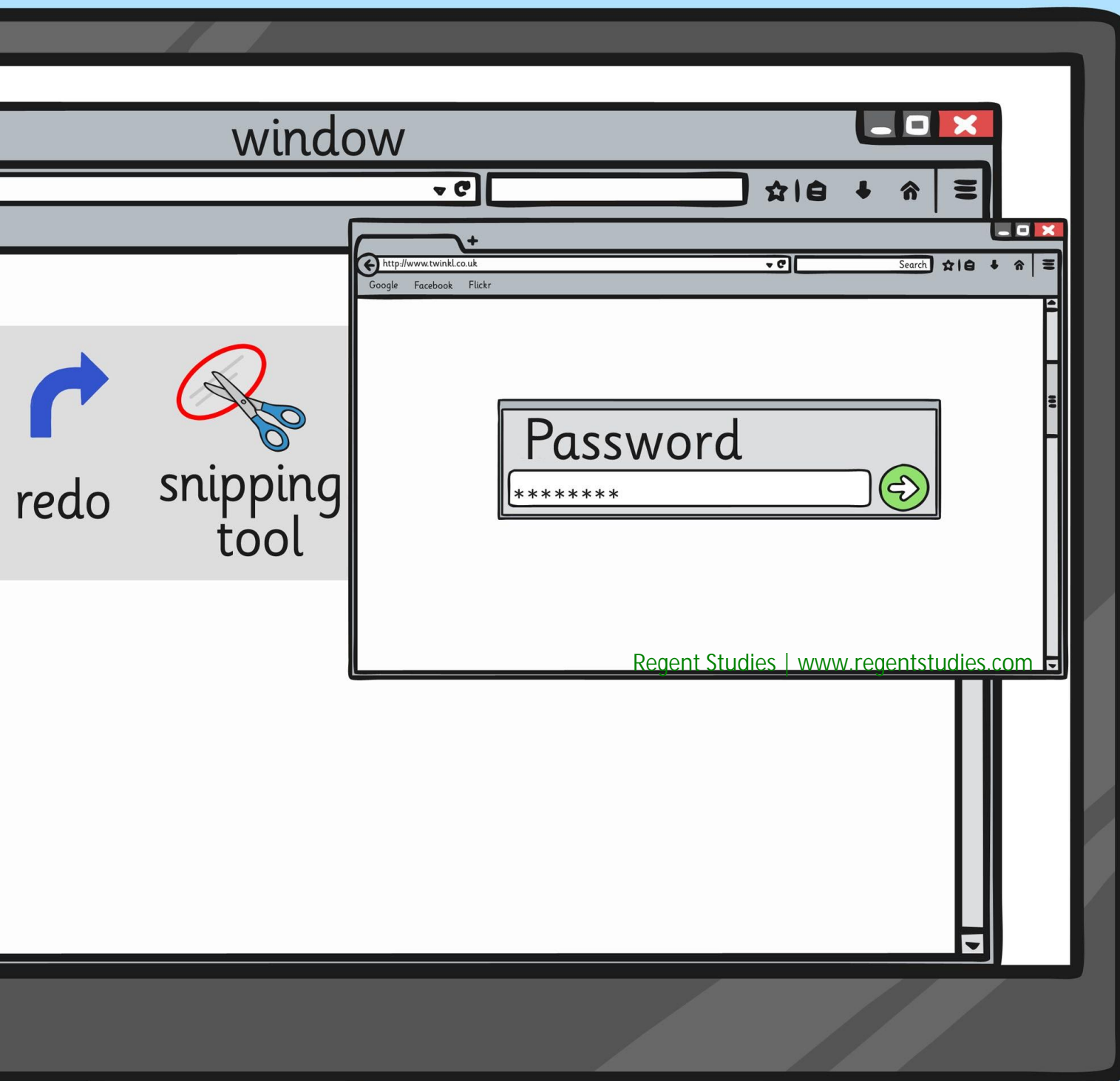

arrow keys

caps lock



shift



minimise



screenshot

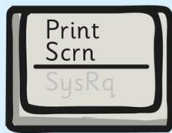

delete

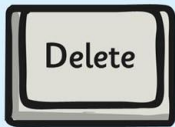

backspace

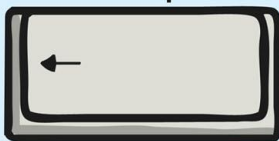

space bar



shortcut



# Word Pro

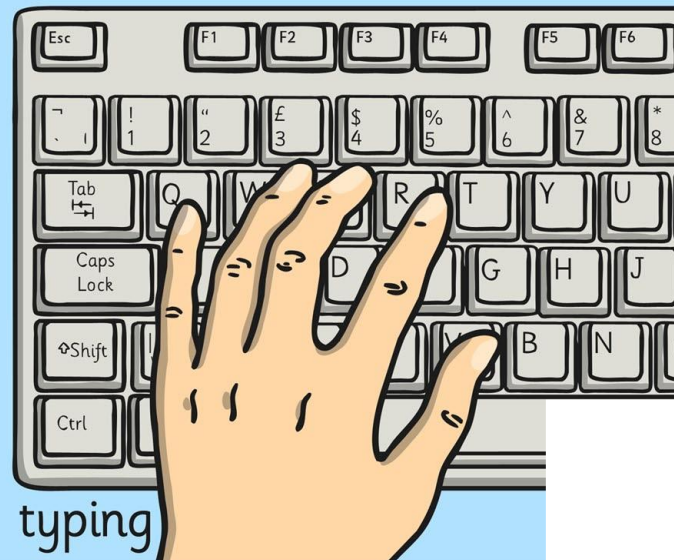
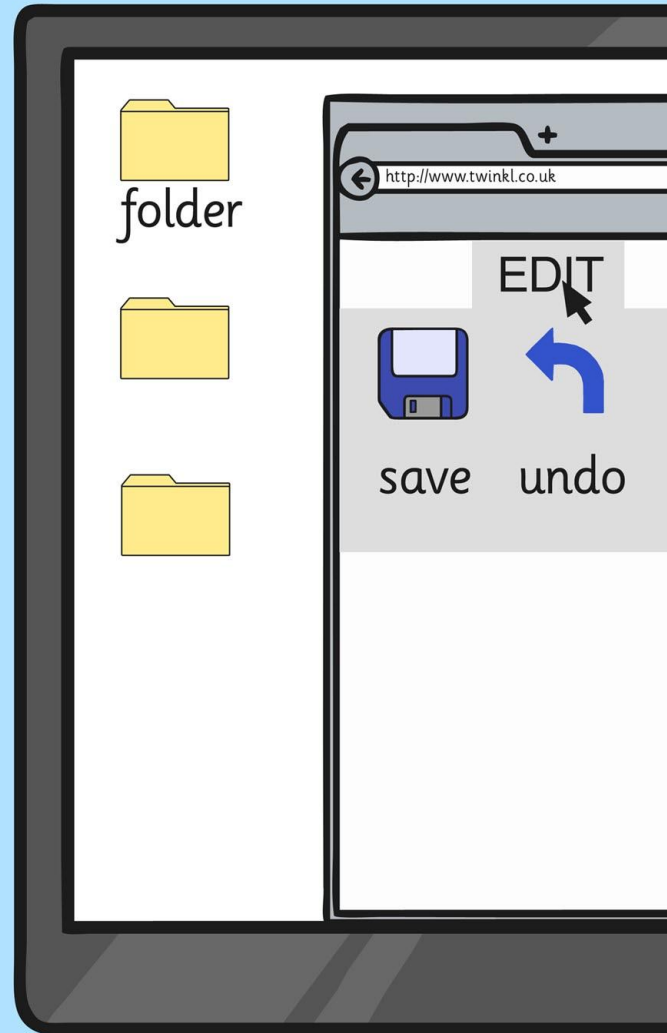



# Processing Skills

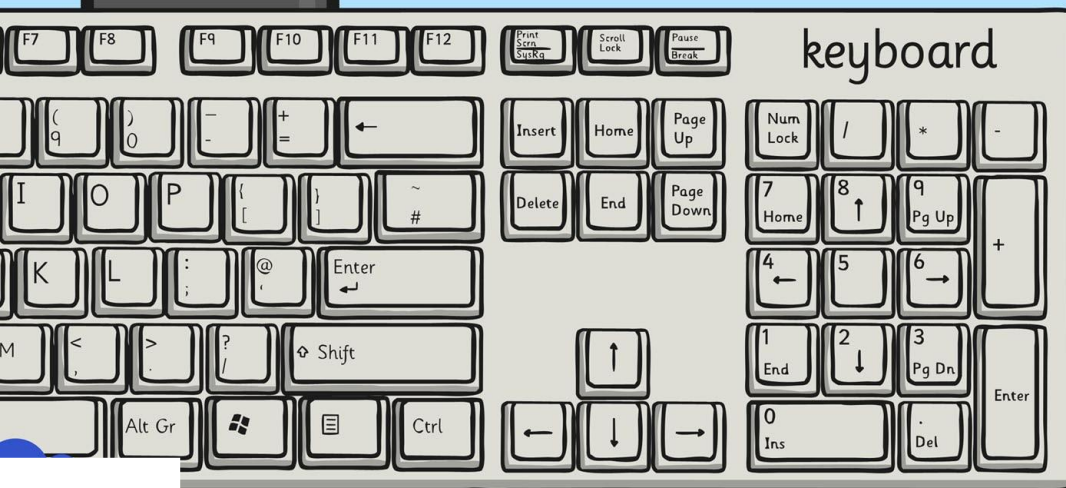
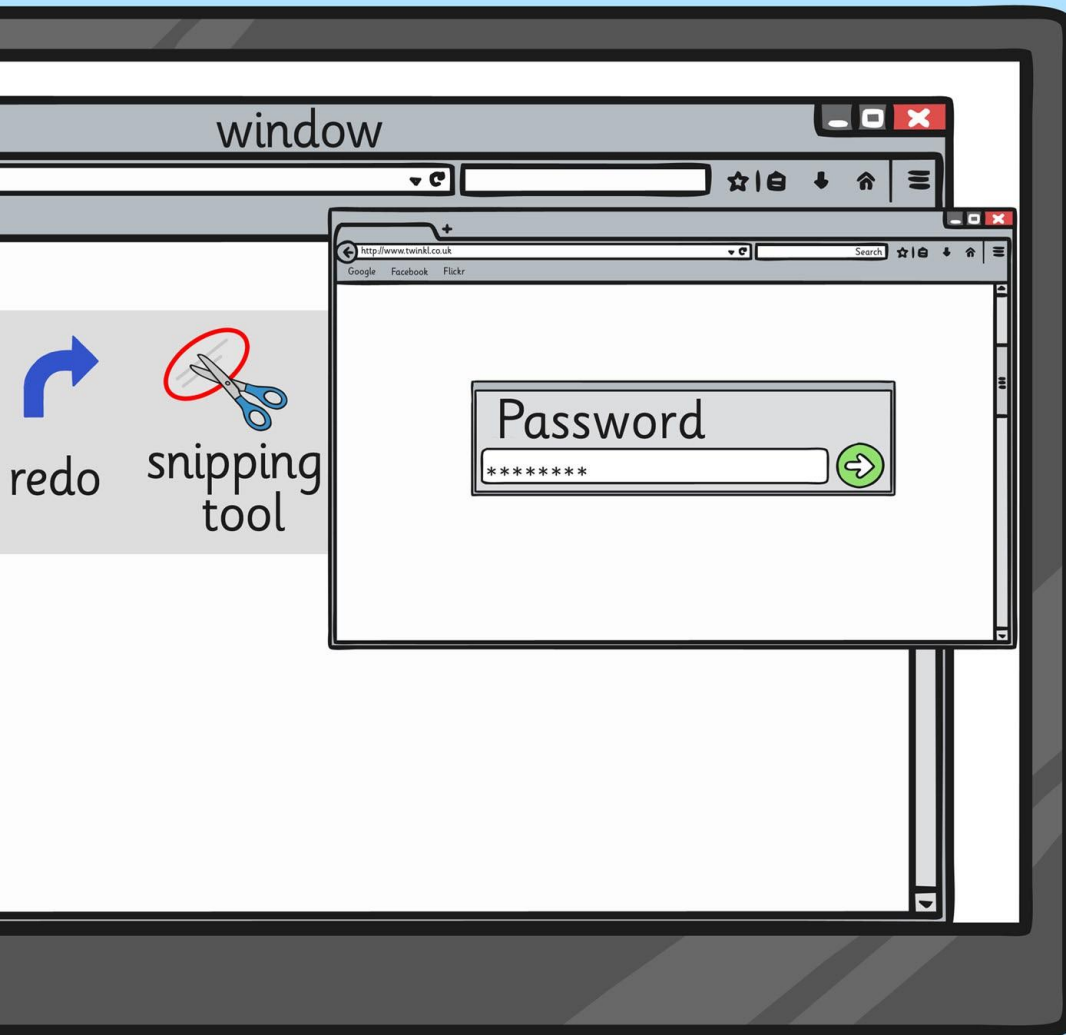

arrow keys

caps lock



shift



minimise



screenshot

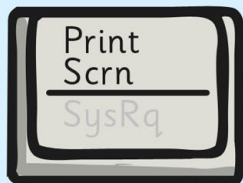

# Word Pro

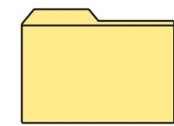

folder

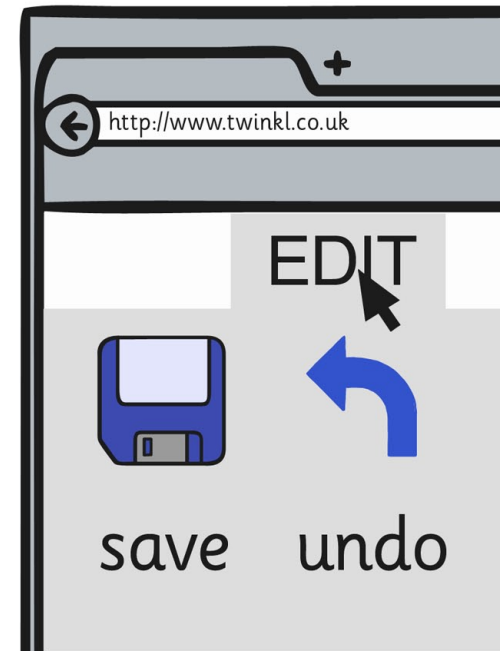
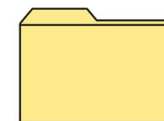
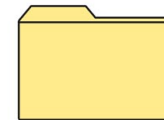

# Processing Skills

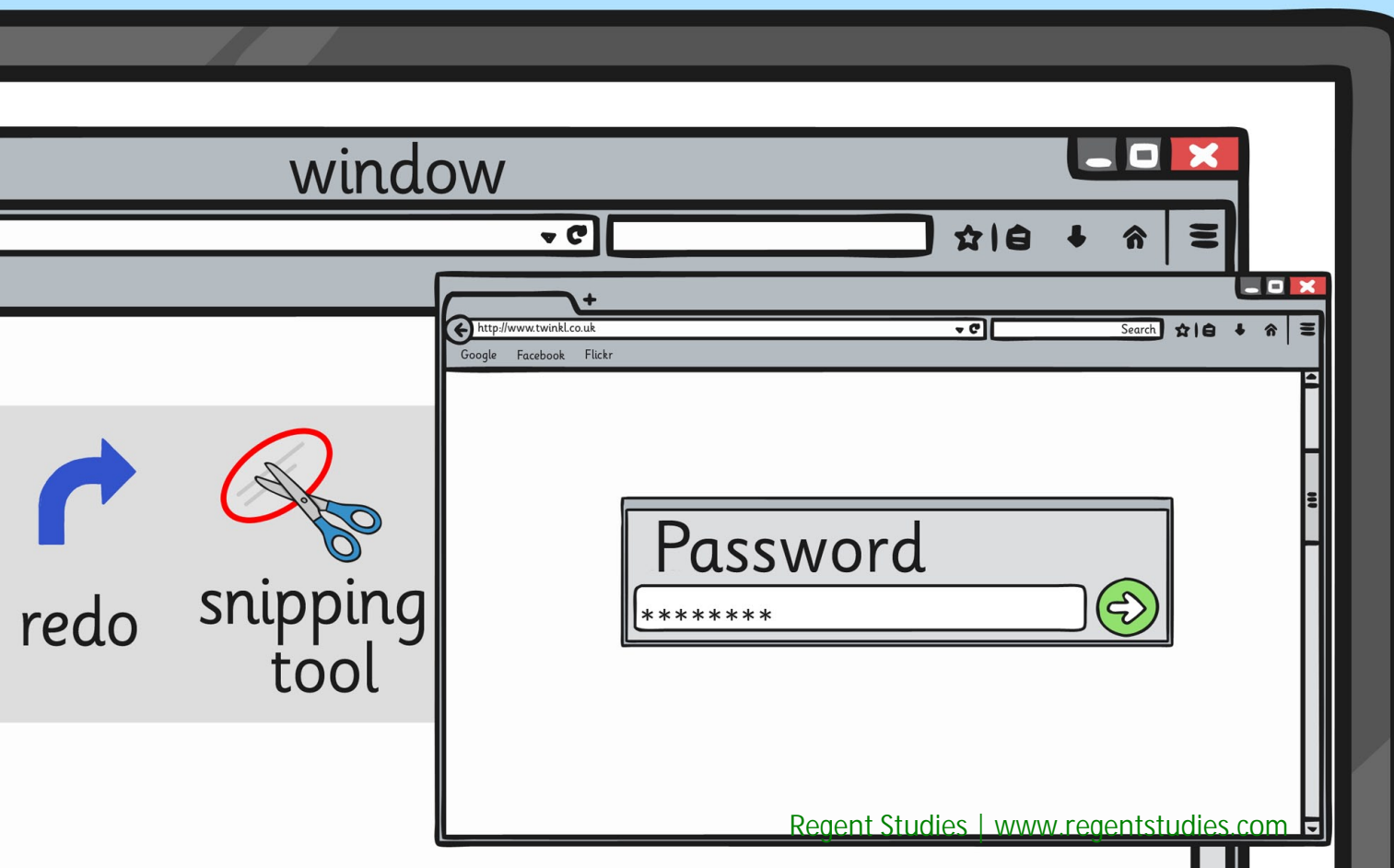

delete

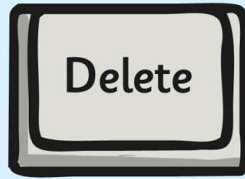

backspace



space bar



shortcut



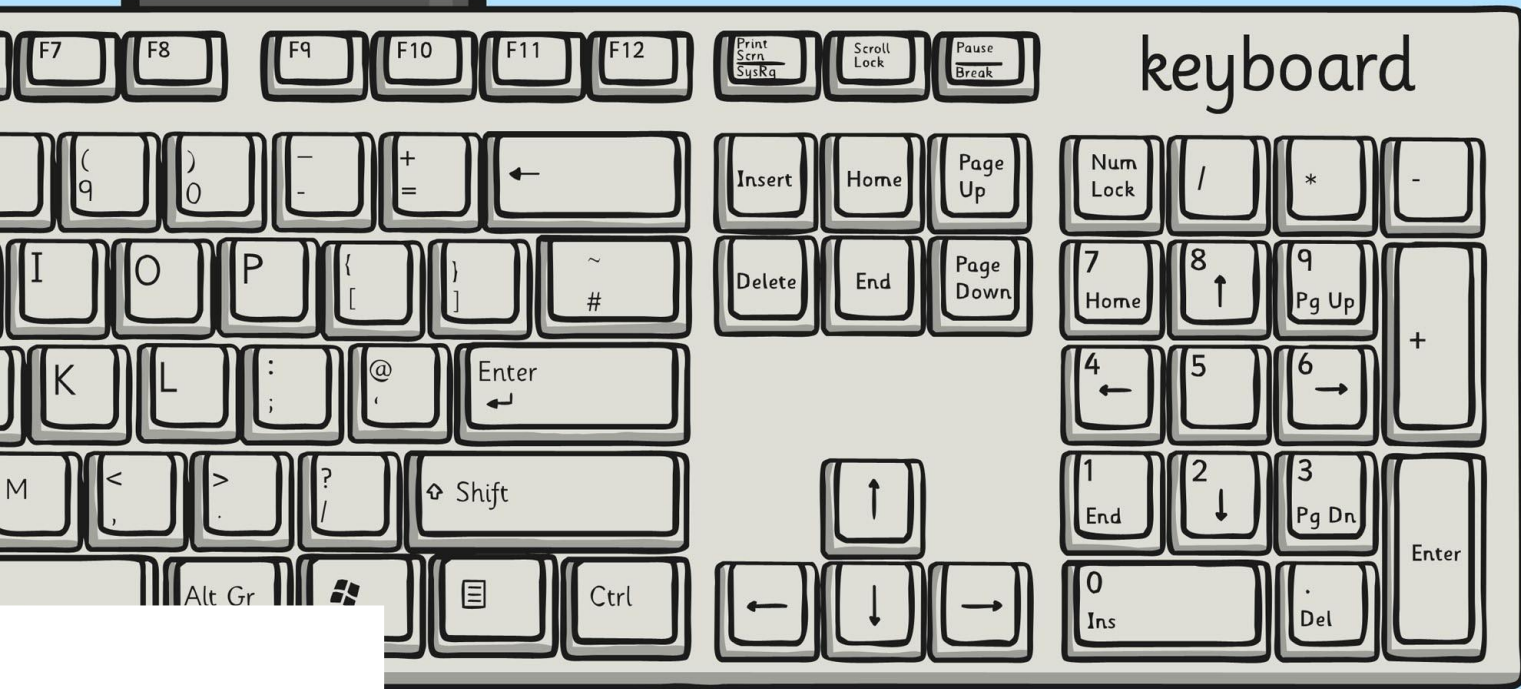

keyboard

arrow keys

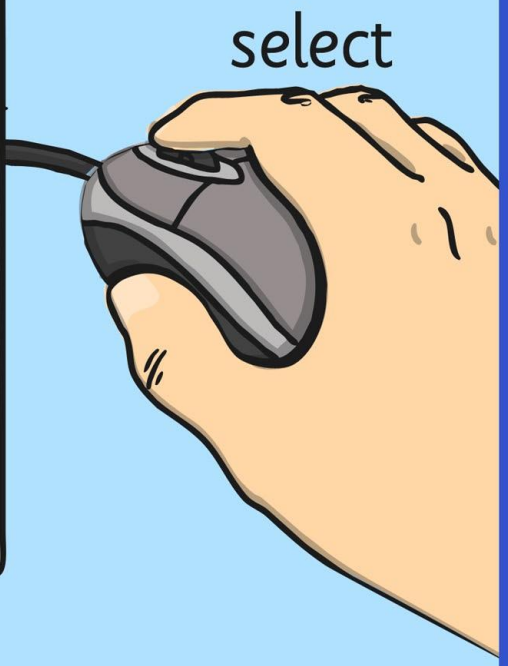

select

# Word Processing Skills

caps lock



shift



minimise



screenshot

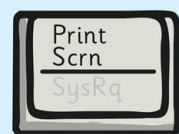

delete

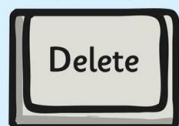

backspace

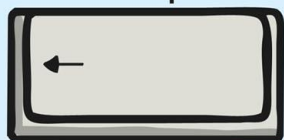

space bar



shortcut

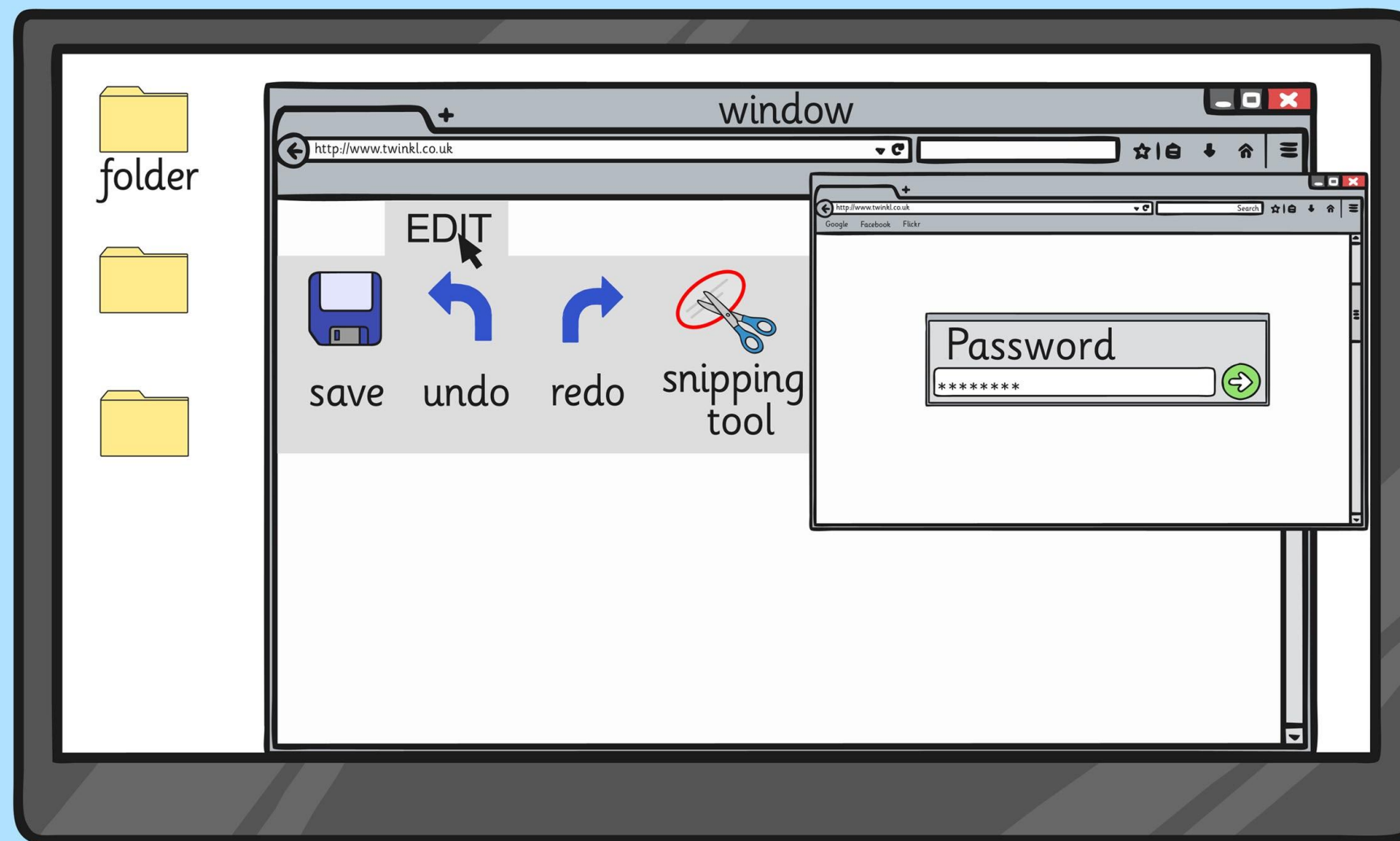

typing

arrow keys

select

# Word Processing Skills

caps lock



shift

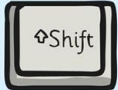

minimise



screenshot



delete

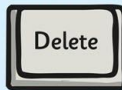

backspace

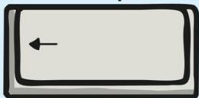

space bar



shortcut

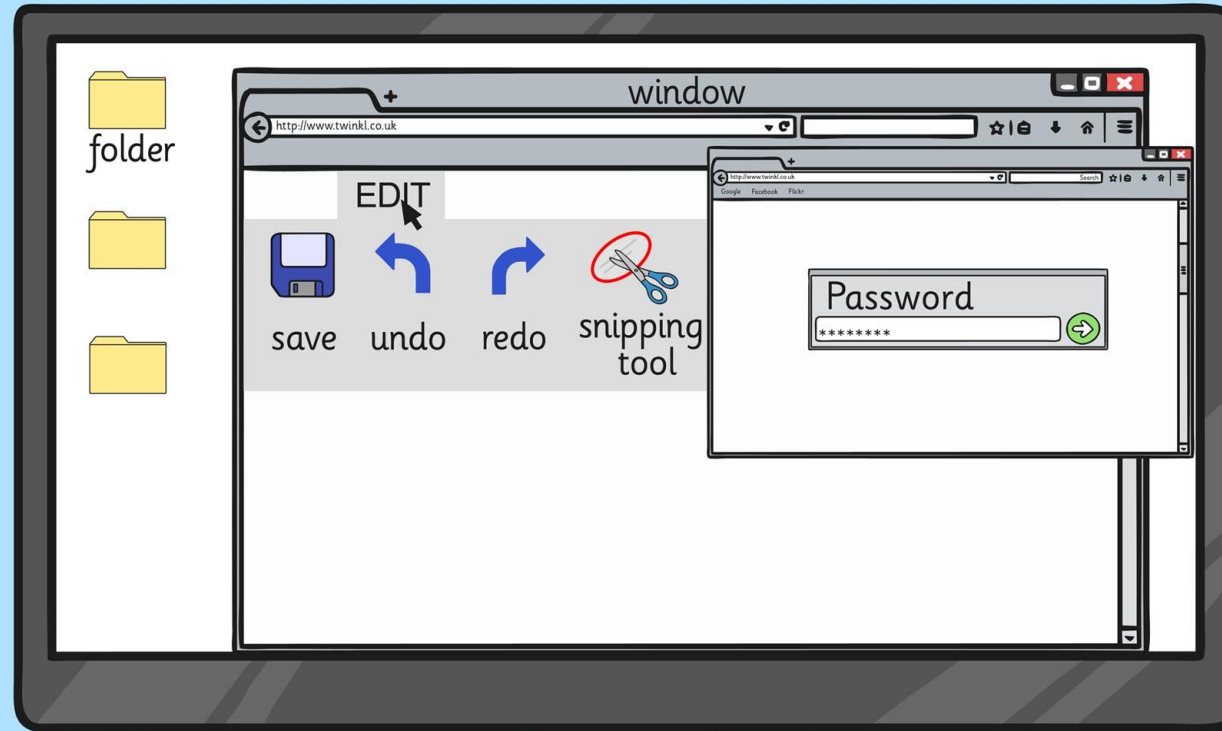

typing

arrow keys

select



# Keyboard





*typing*



save

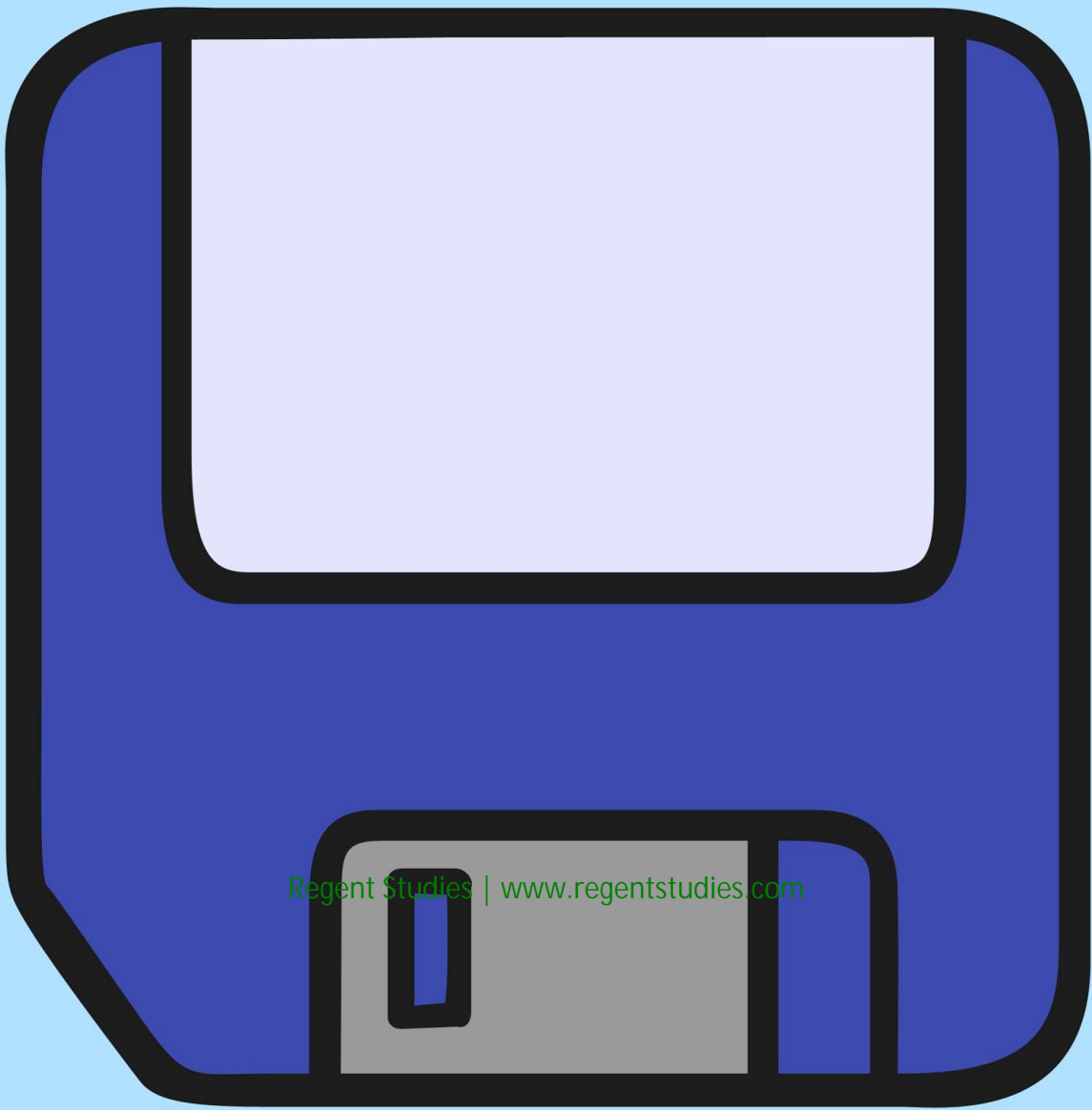

Regent Studies | [www.regentstudies.com](http://www.regentstudies.com)

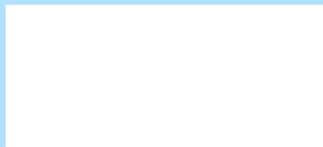

folder

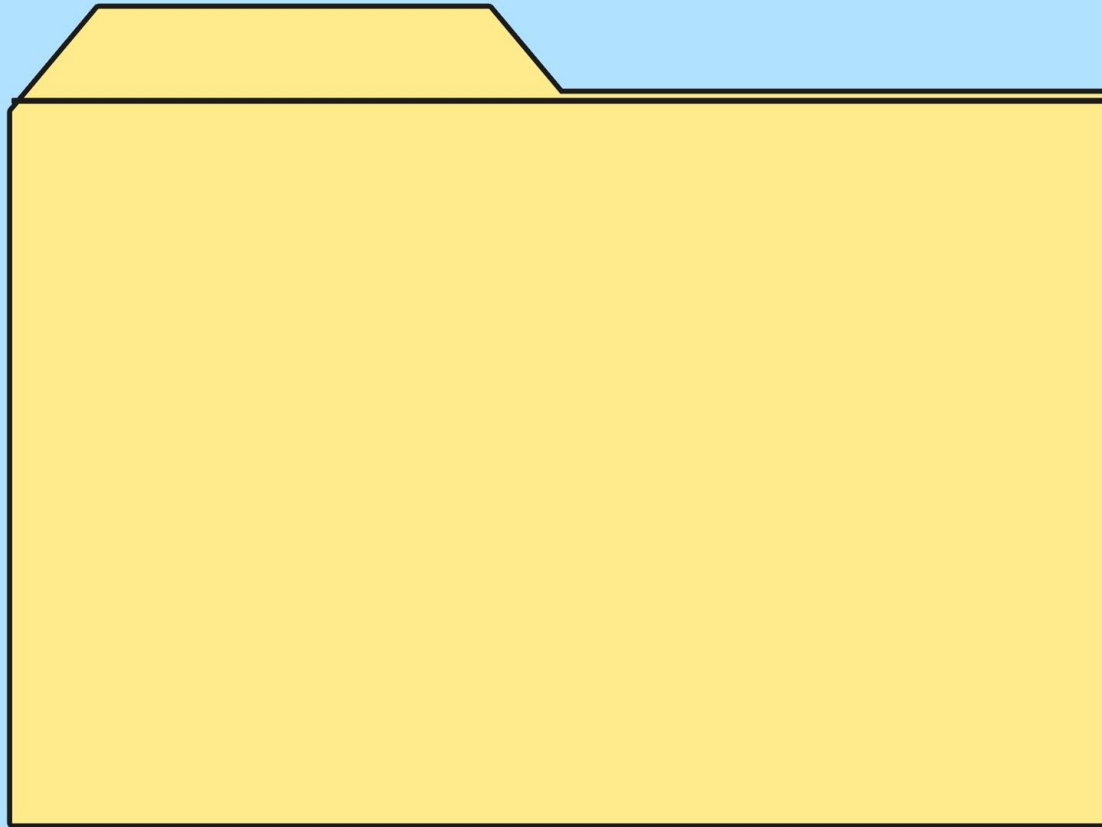

*shift*

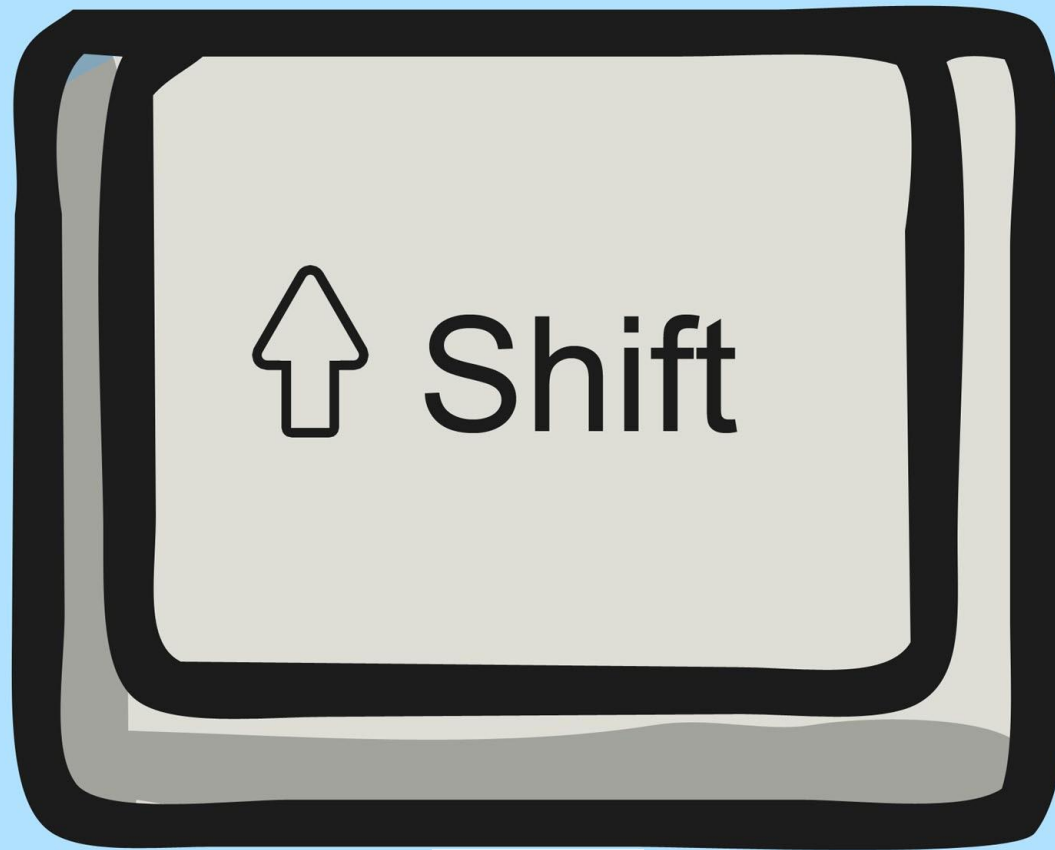

# Caps Lock



*spacebar*

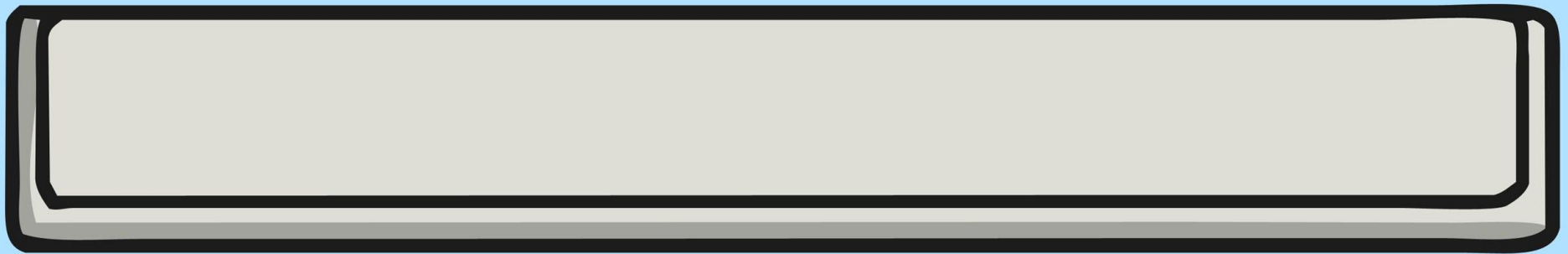

*edit*

**EDIT**

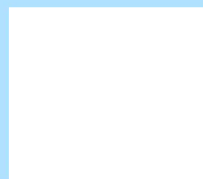
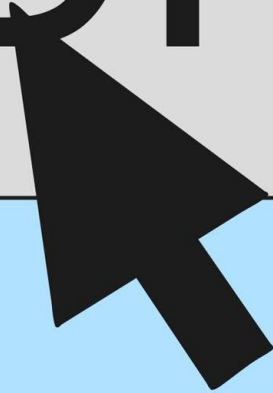

*backspace*

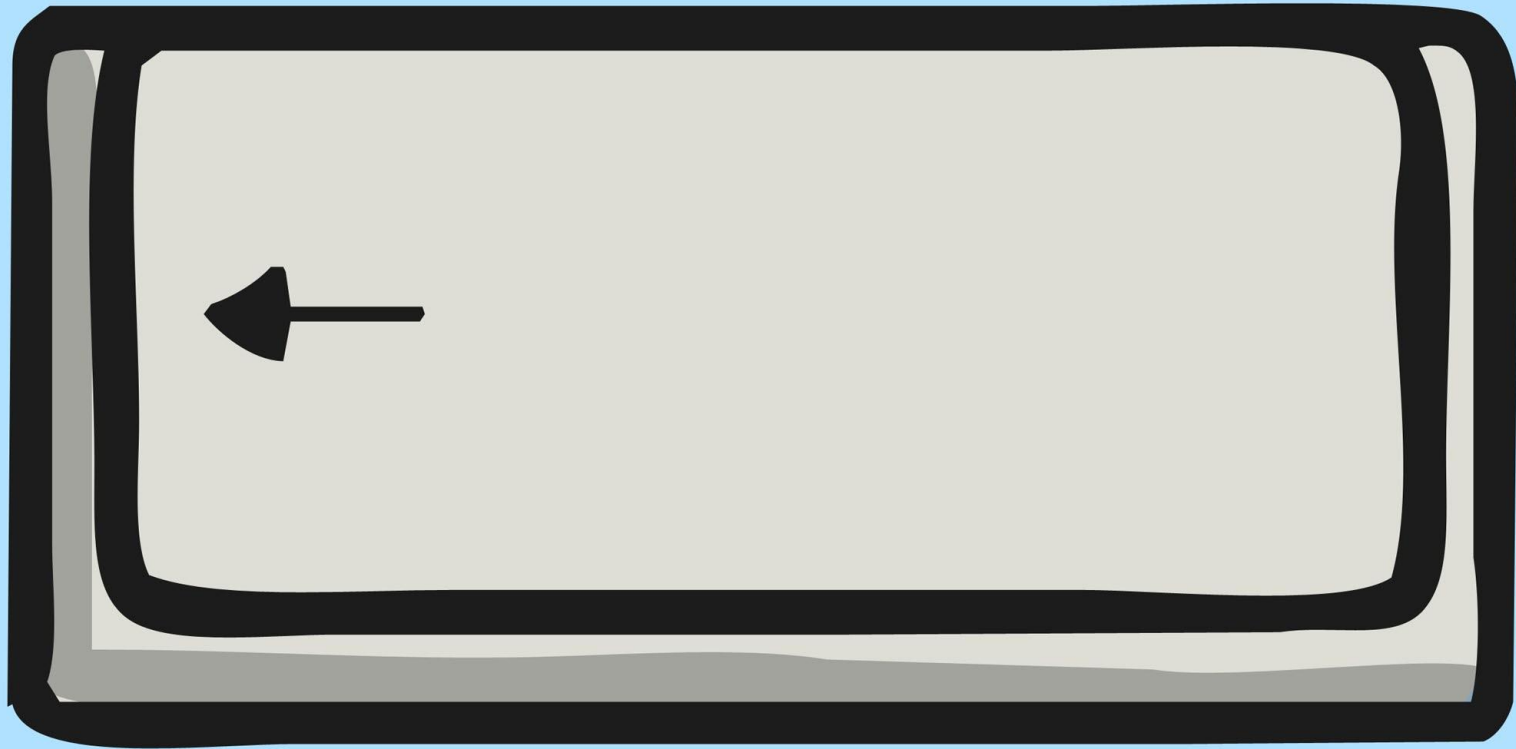



*delete*

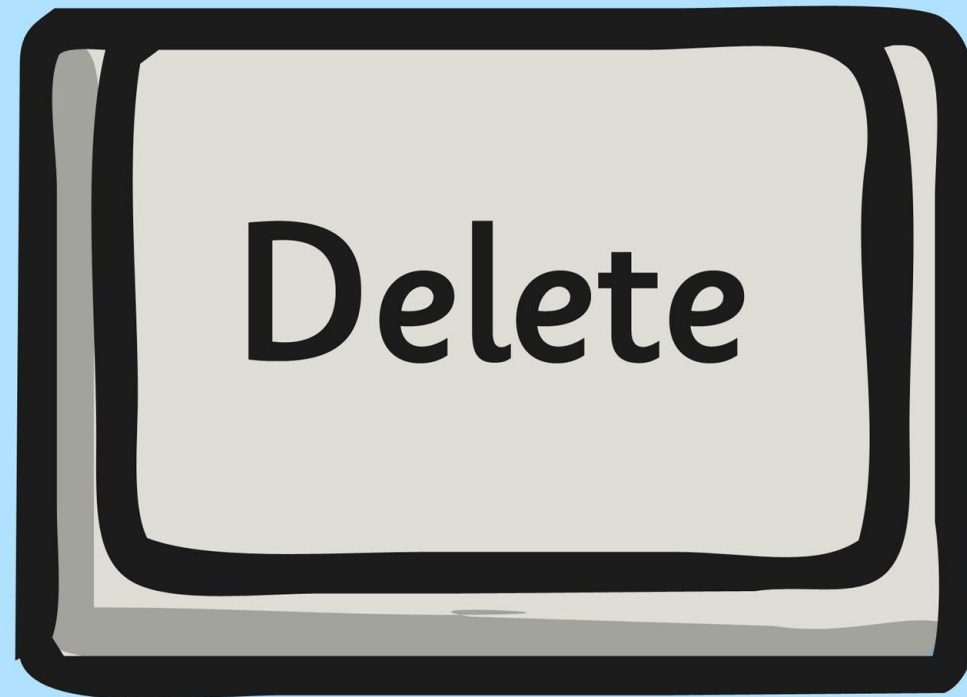

arrow keys

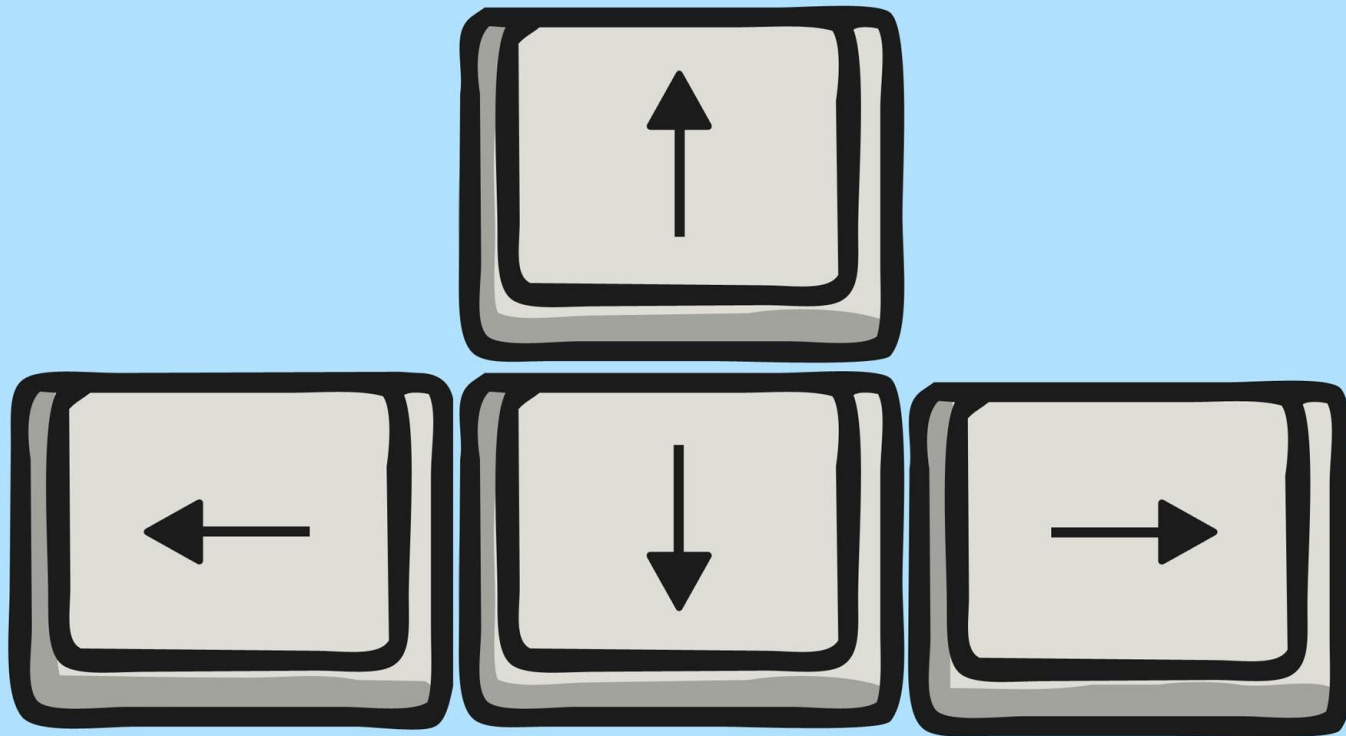

*undo*

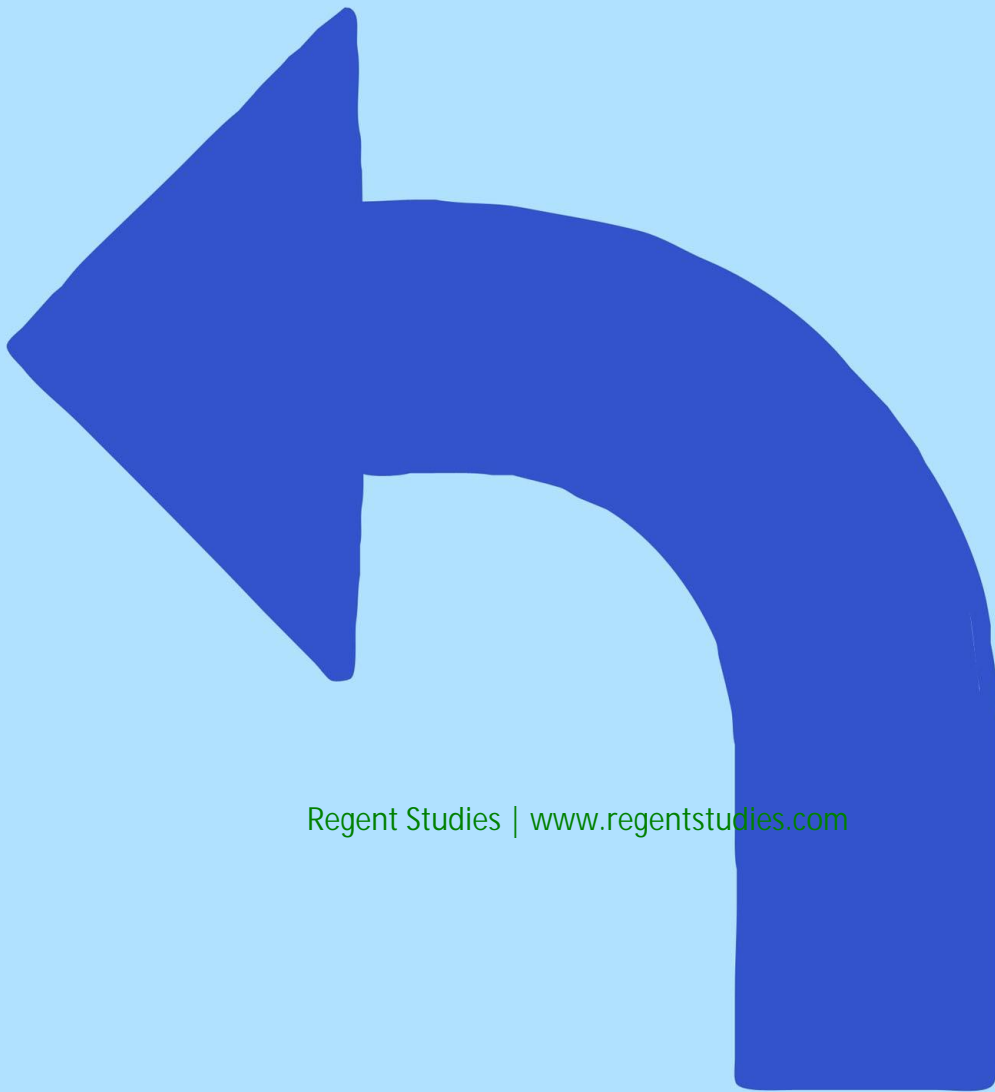

Regent Studies | [www.regentstudies.com](http://www.regentstudies.com)



redo

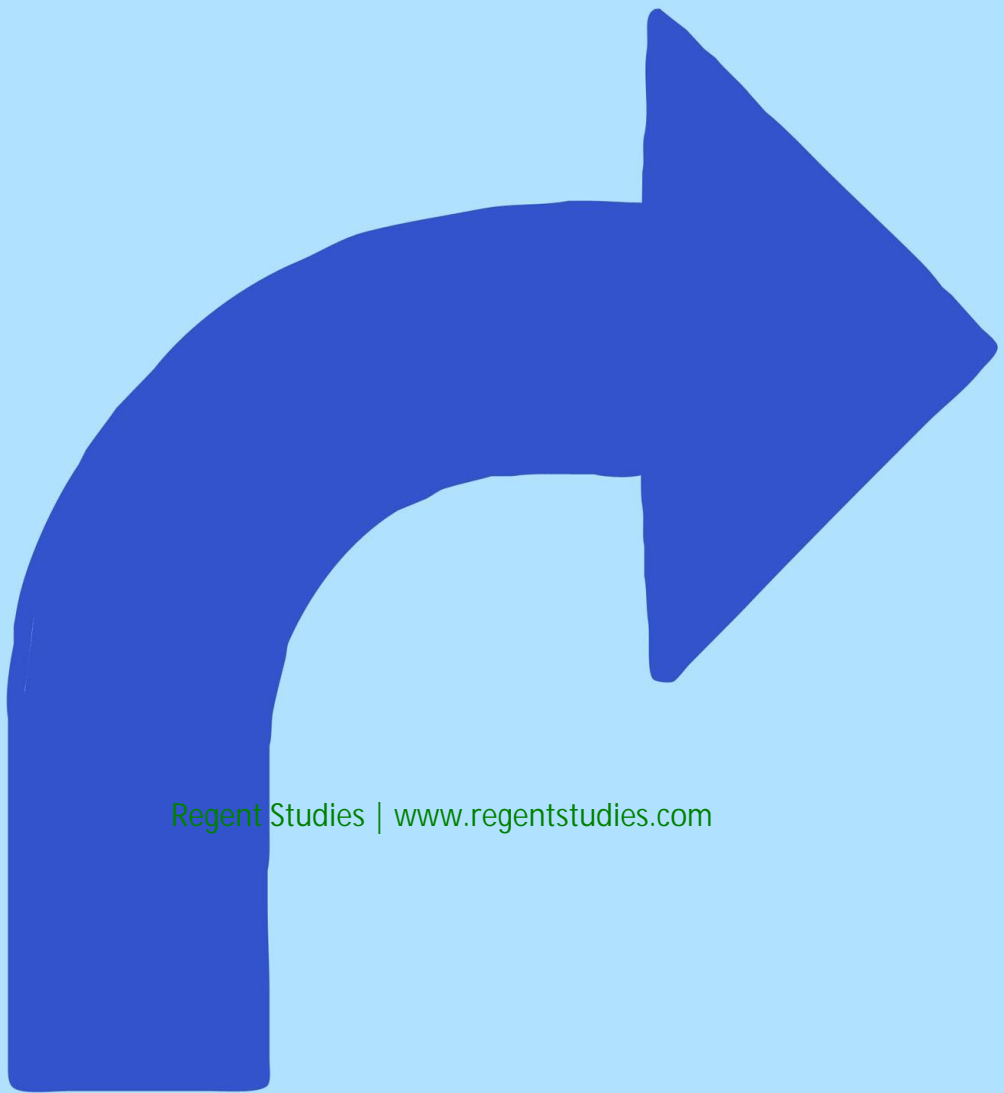

Regent Studies | [www.regentstudies.com](http://www.regentstudies.com)

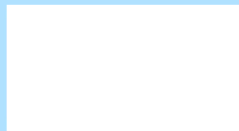

*select*

*click*  
*click*

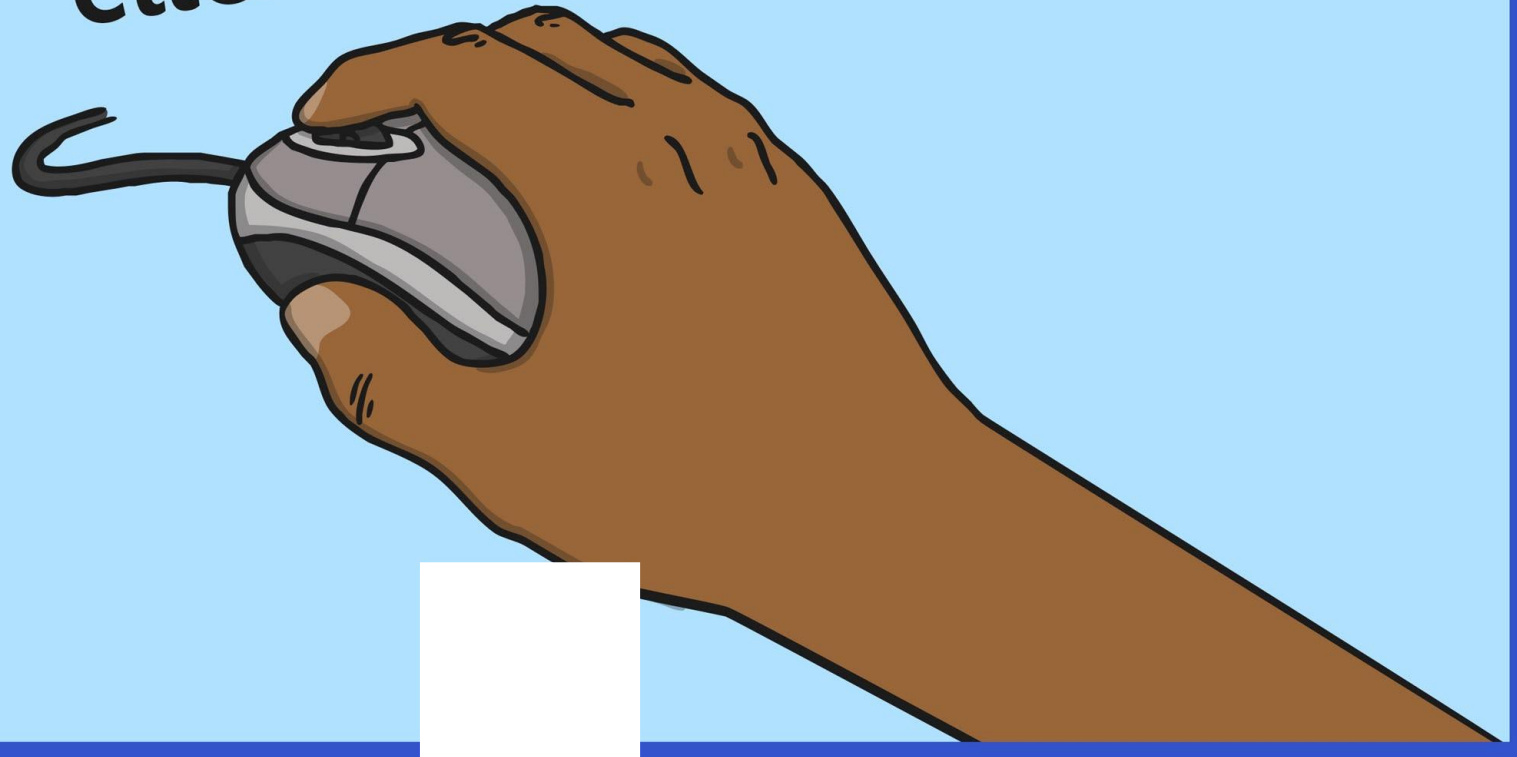

*window*

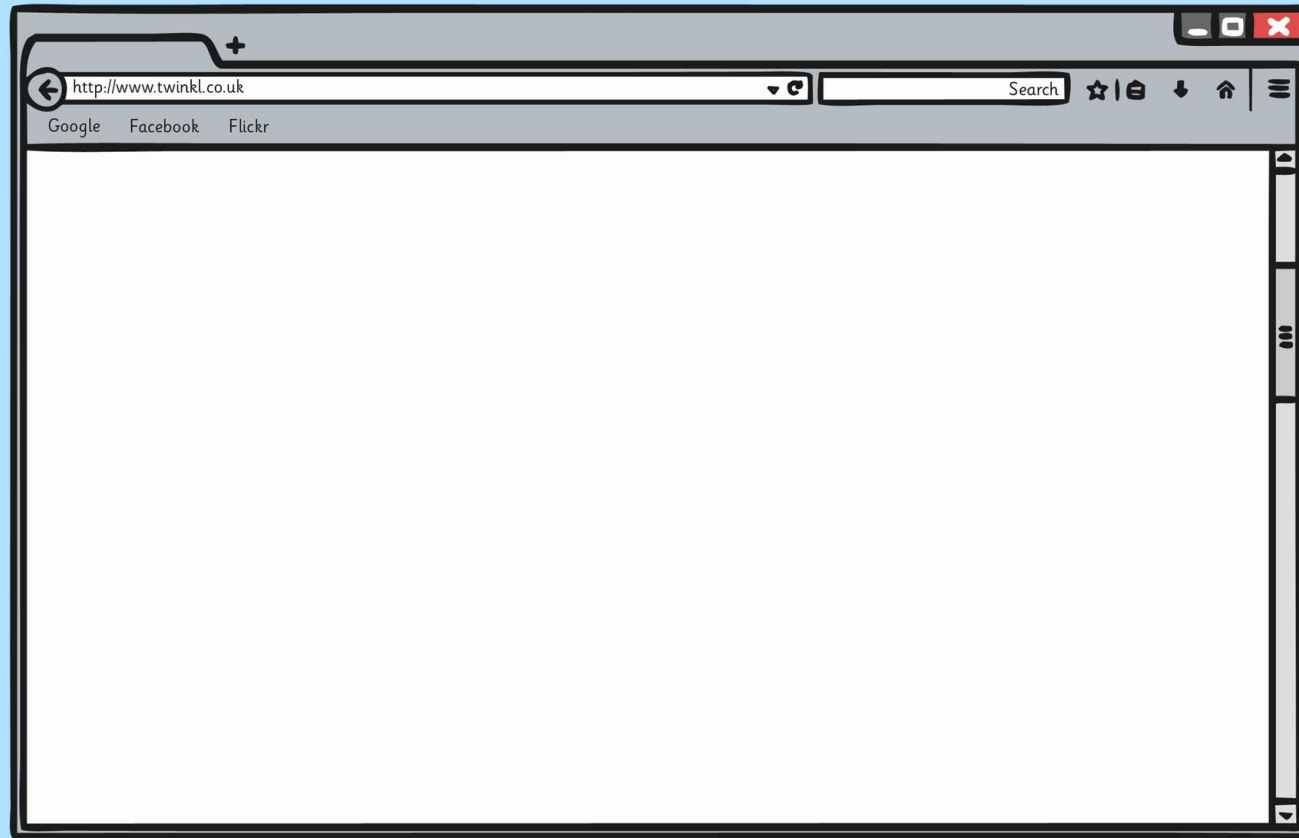

*minimise*

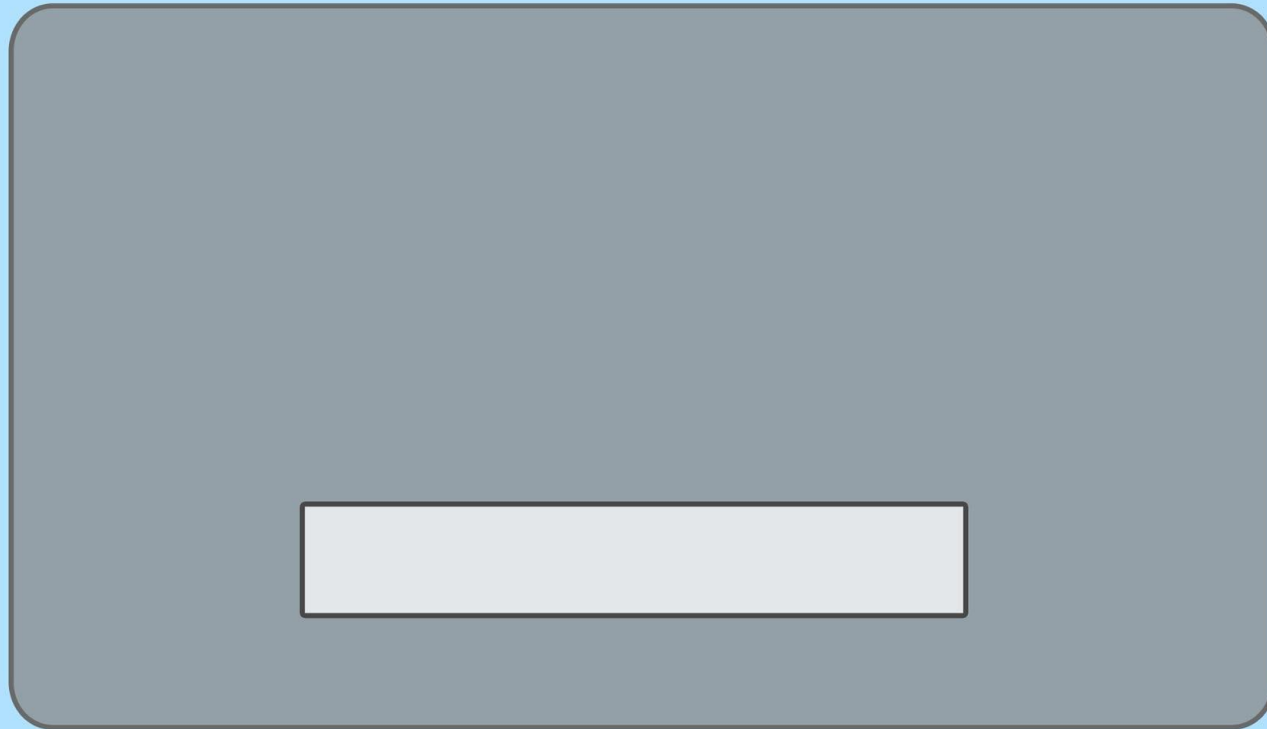

password

Password

\*\*\*\*\*





*screenshot*

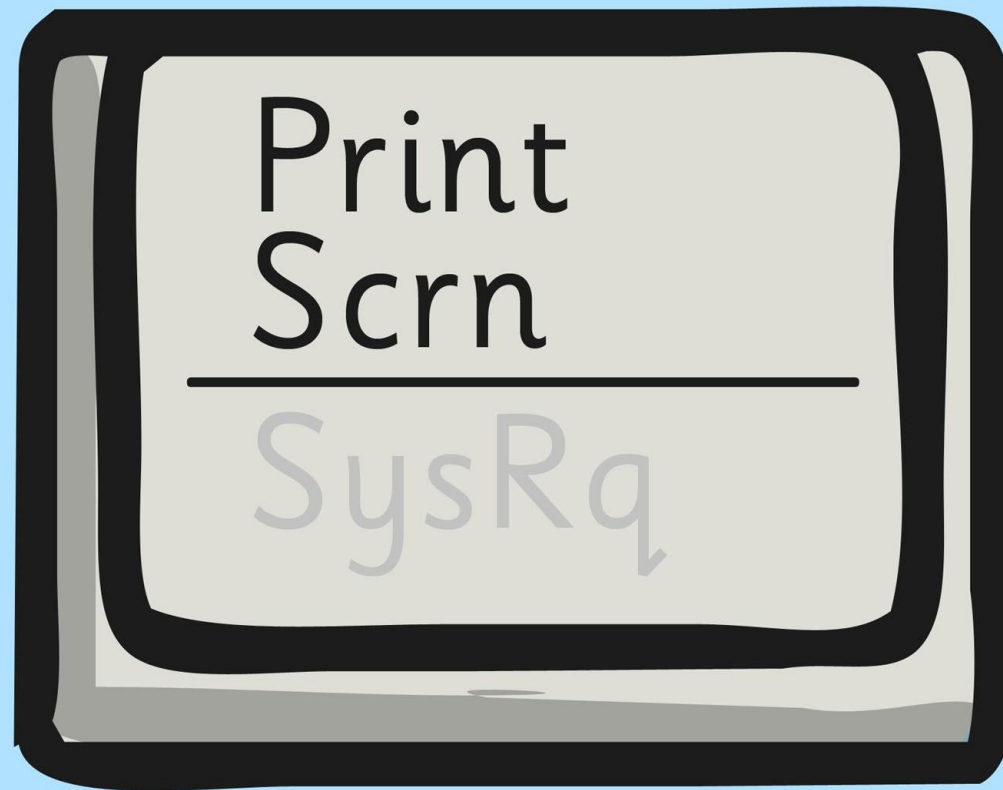

*snipping tool*

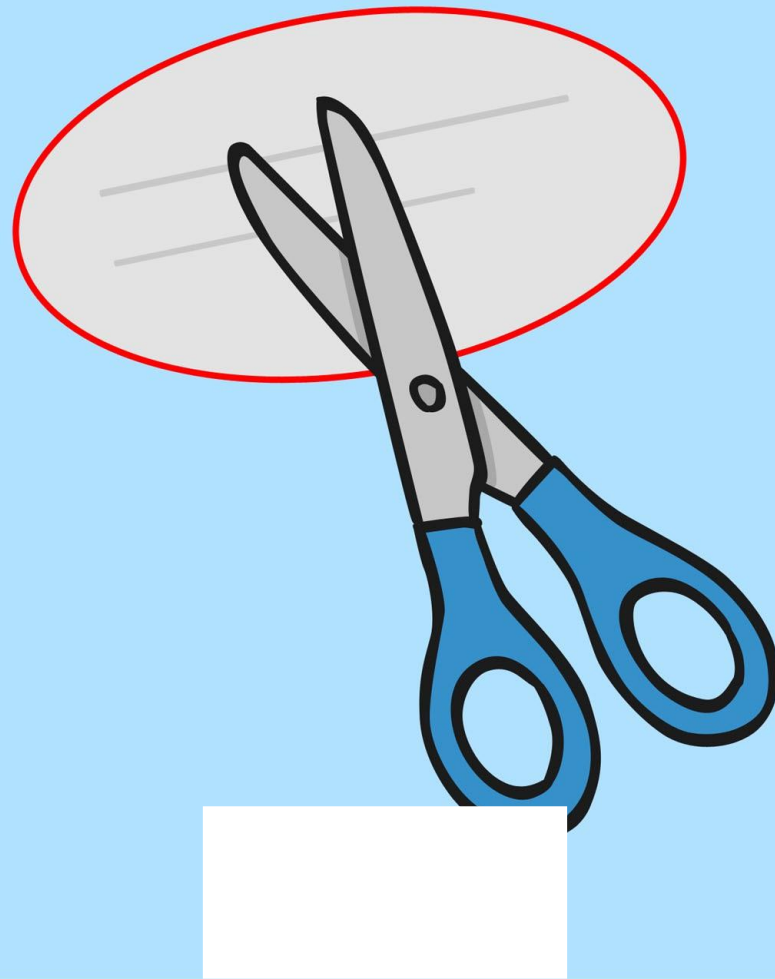

# shortcut

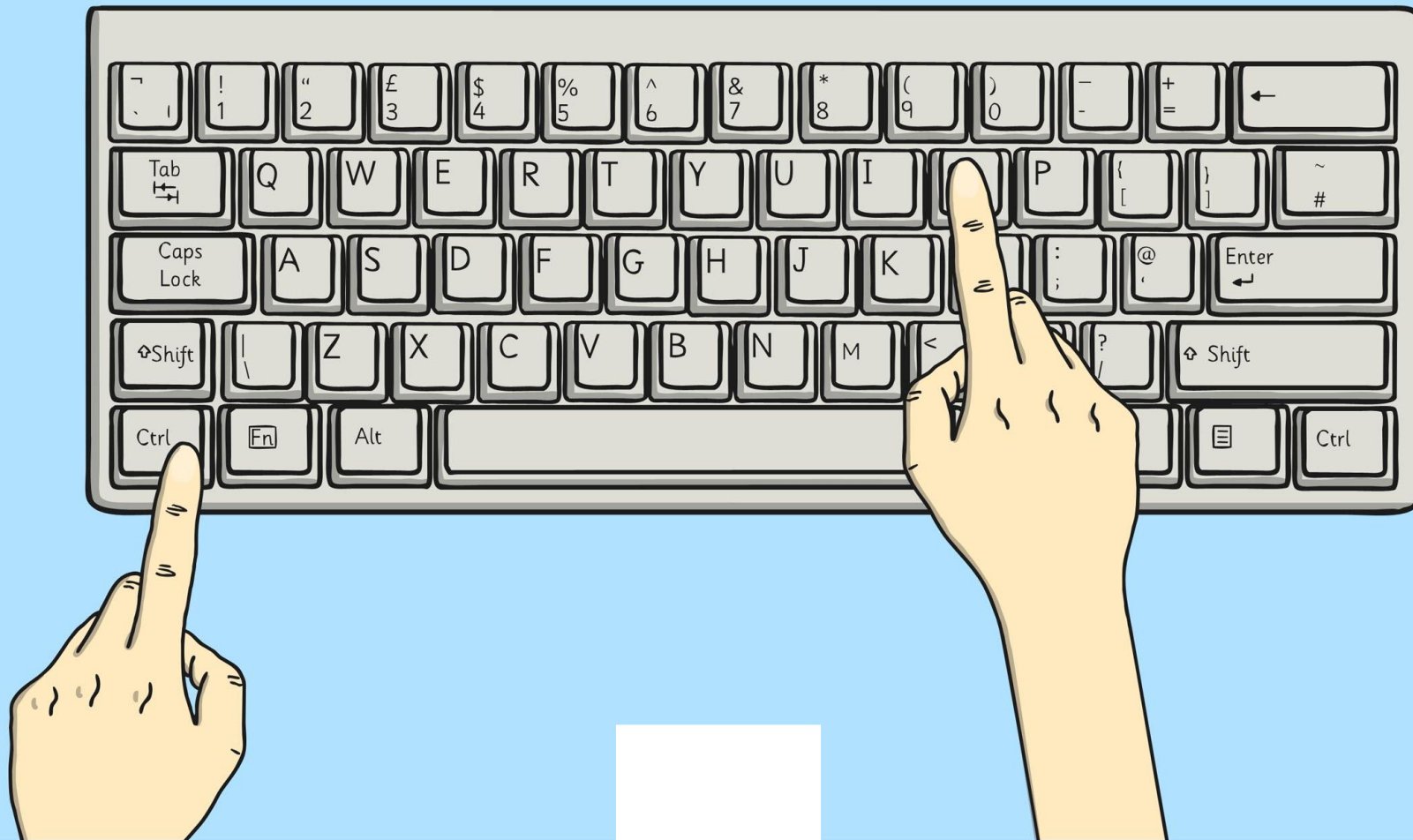

# Keyboard



# typing



save

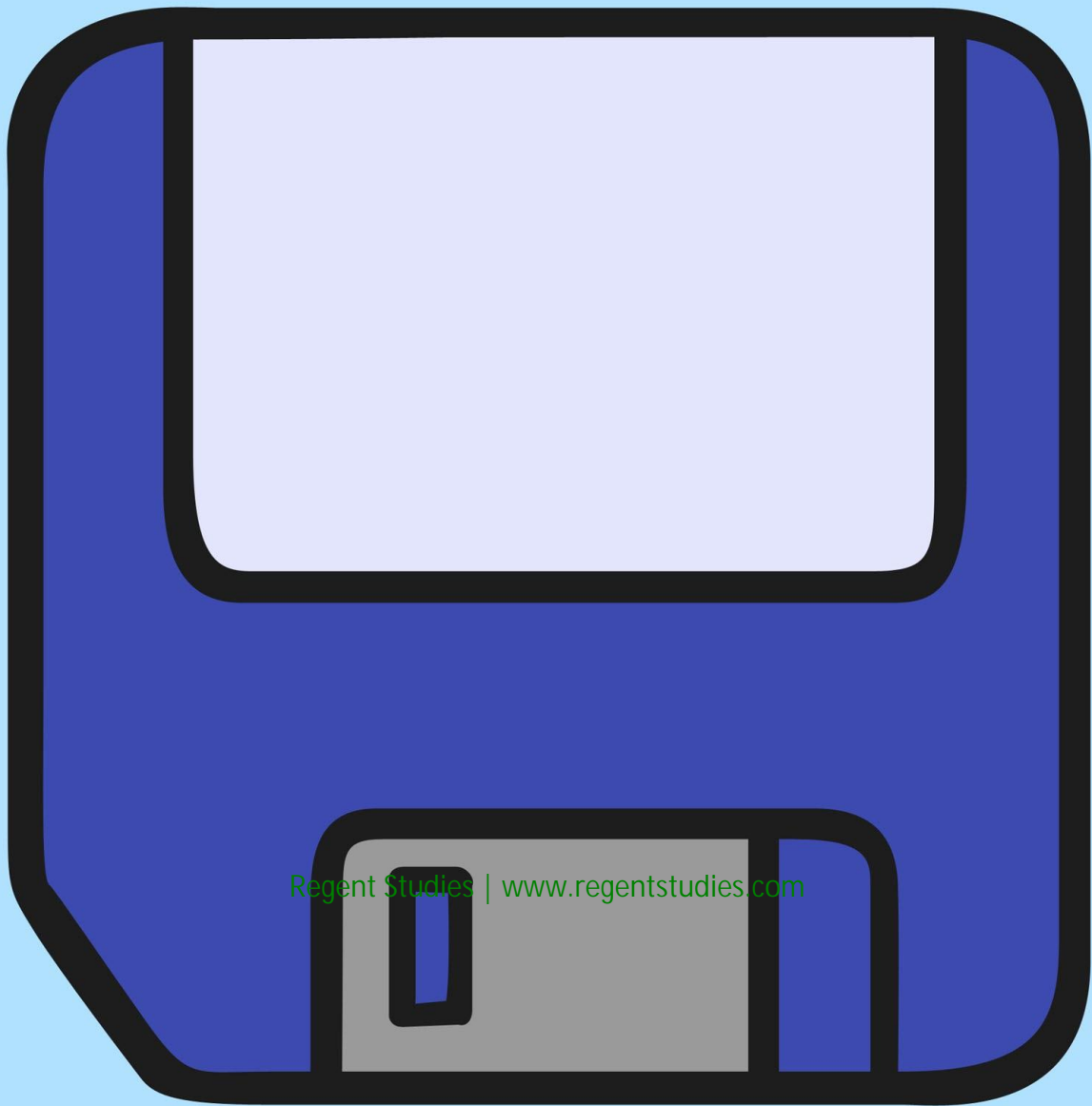

Regent Studies | [www.regentstudies.com](http://www.regentstudies.com)

# folder

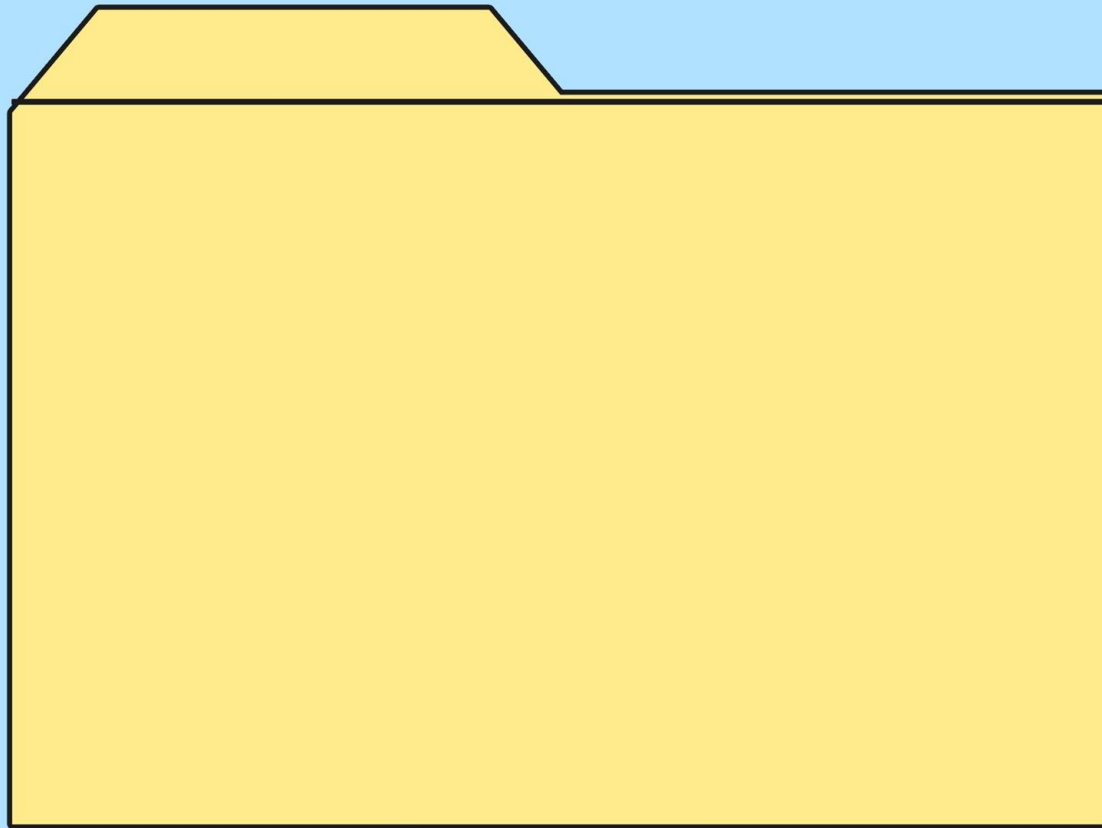

# shift

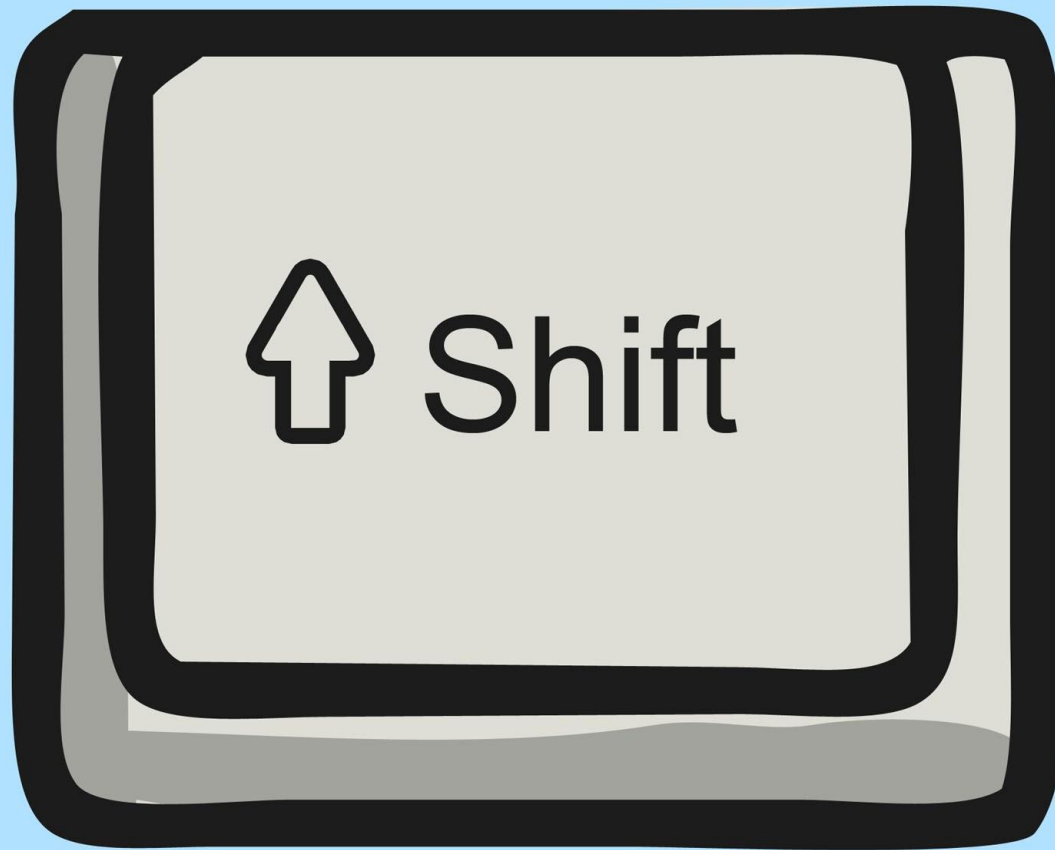



# Caps Lock



# spacebar

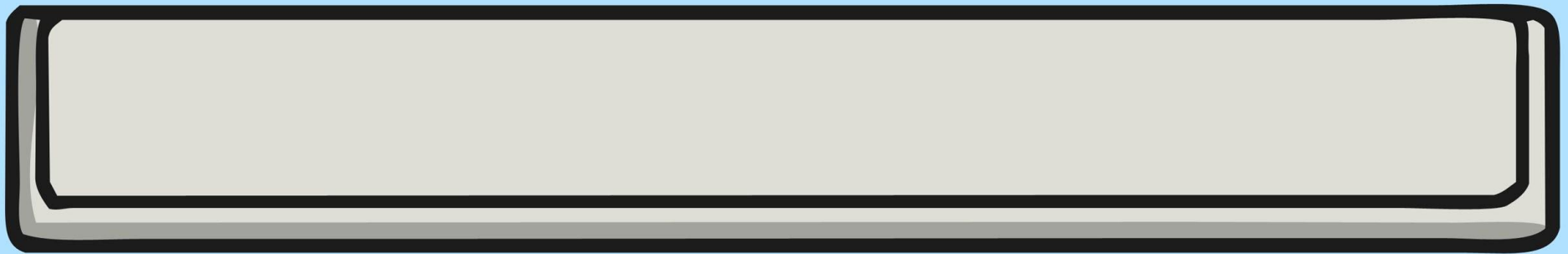

edit

EDIT

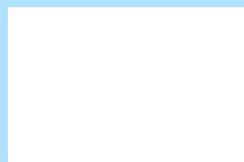
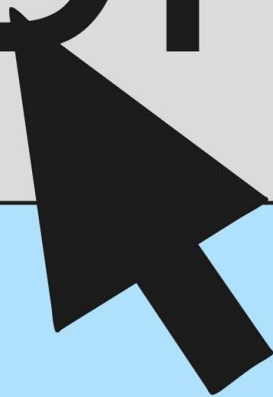

# backspace

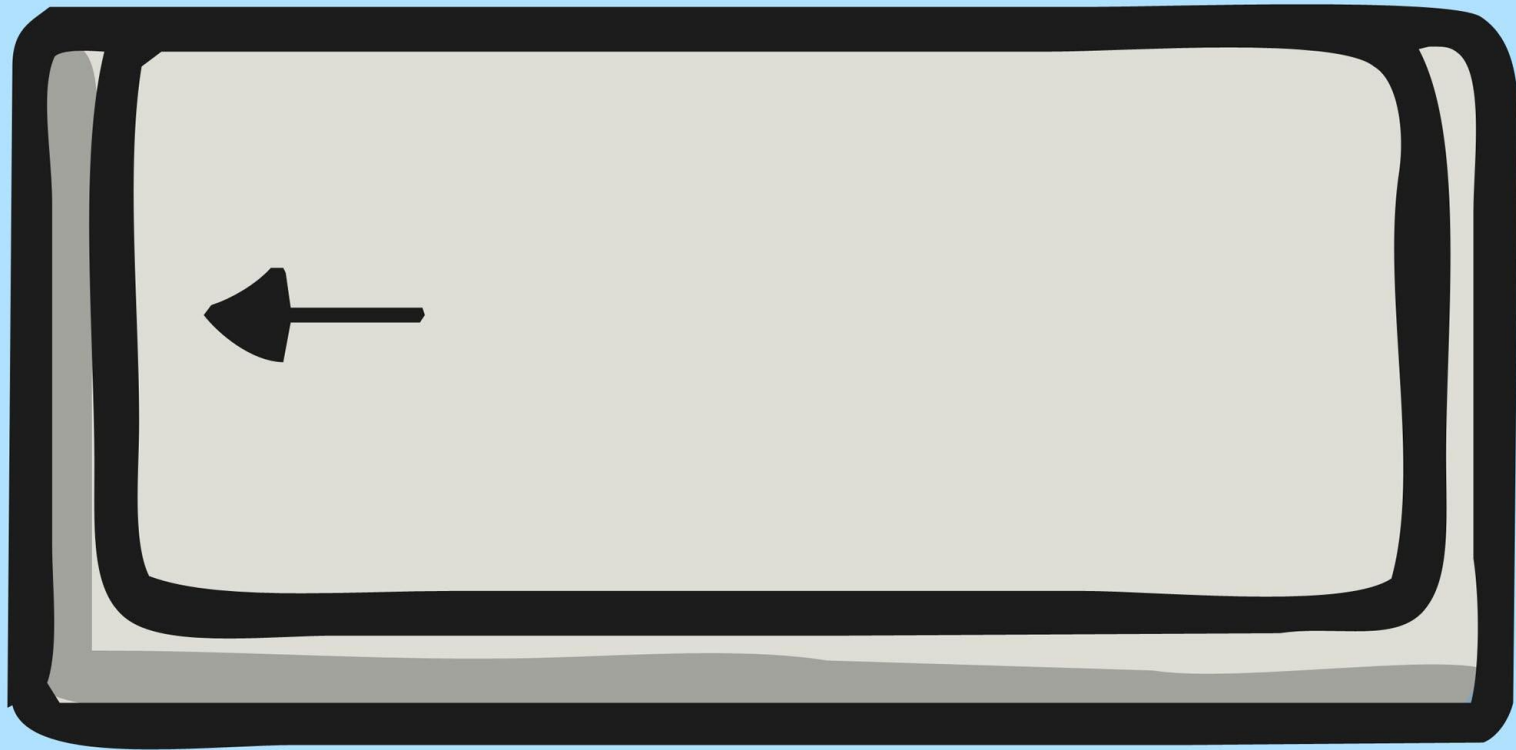

delete

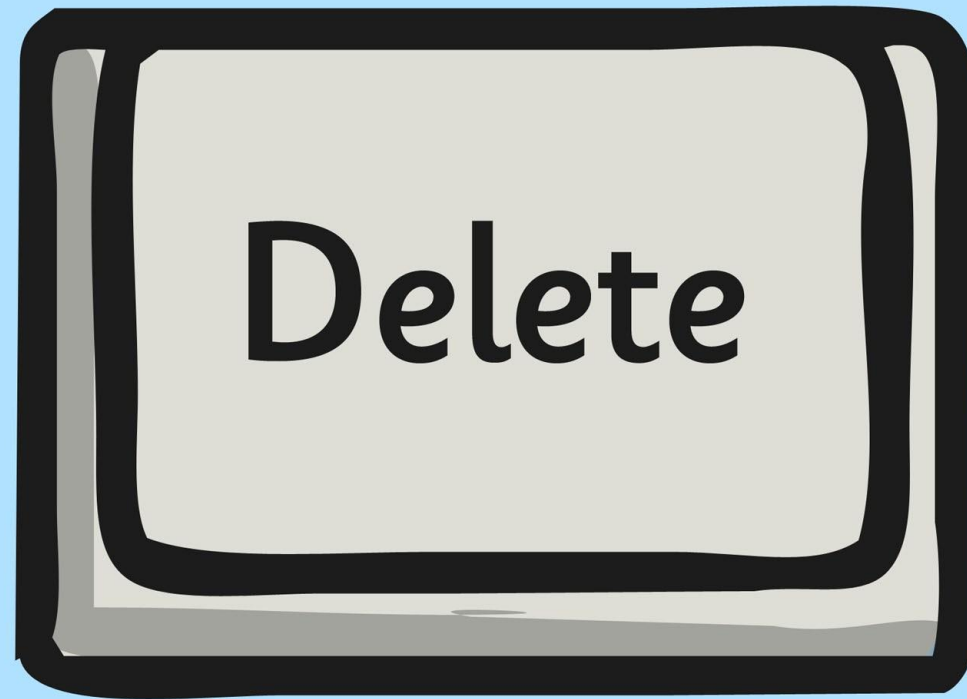

# arrow keys

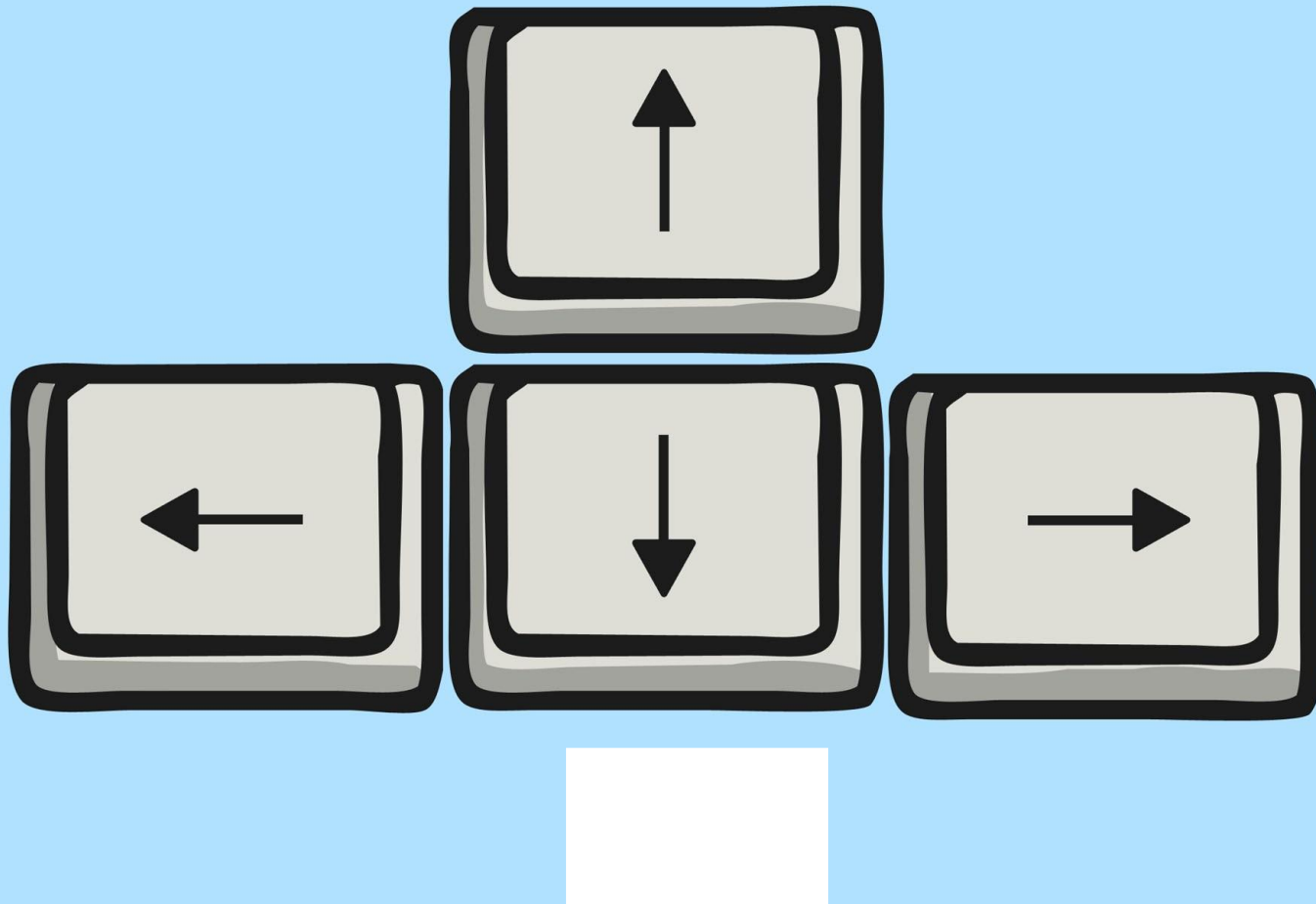

# undo

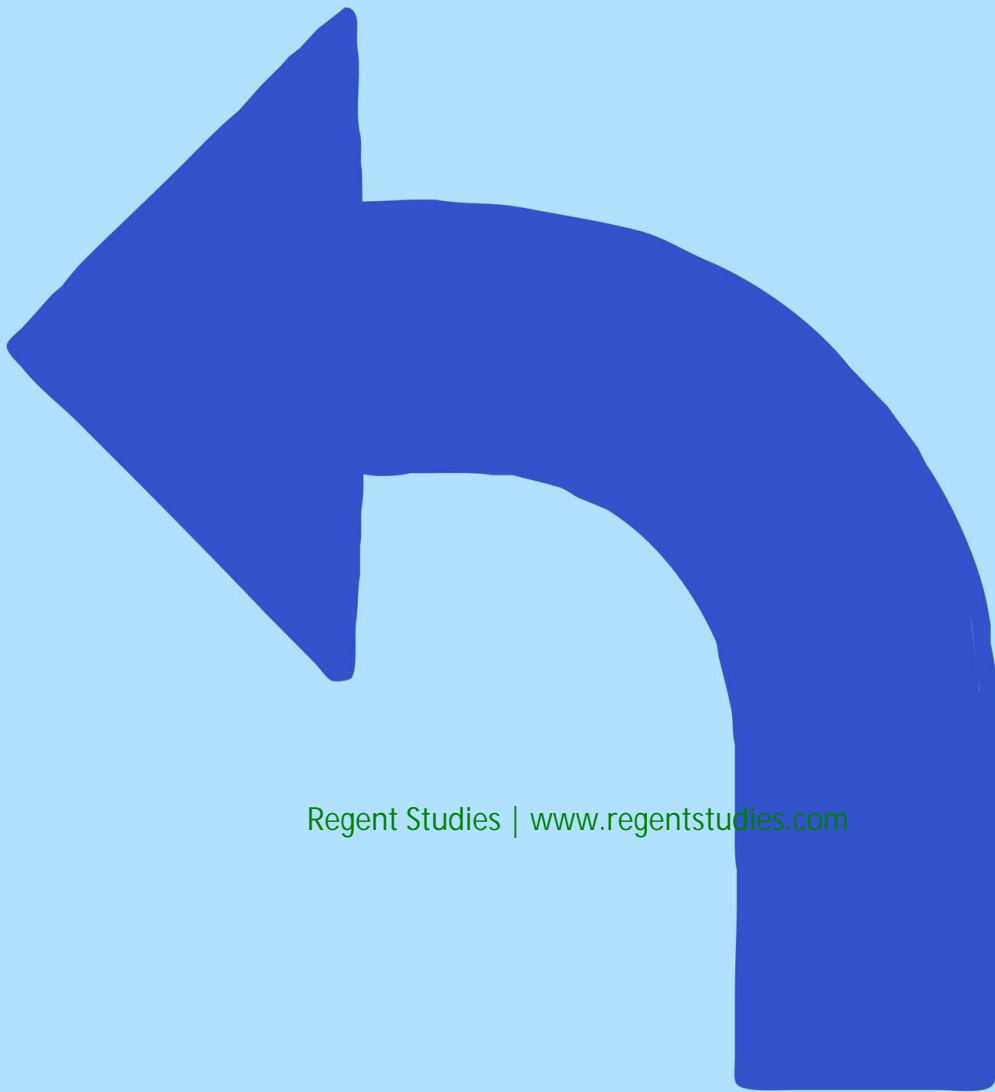

Regent Studies | [www.regentstudies.com](http://www.regentstudies.com)

# redo

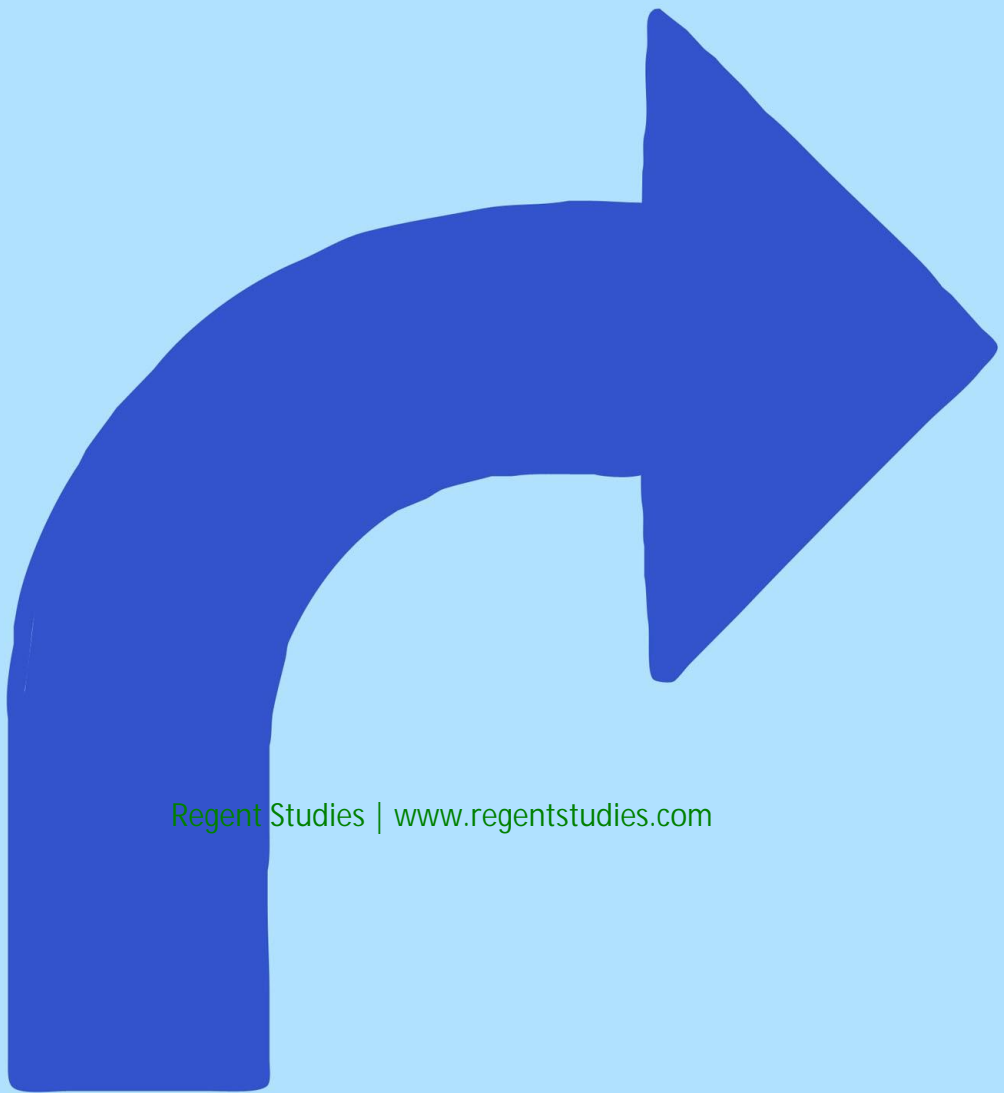

Regent Studies | [www.regentstudies.com](http://www.regentstudies.com)





# select



# window

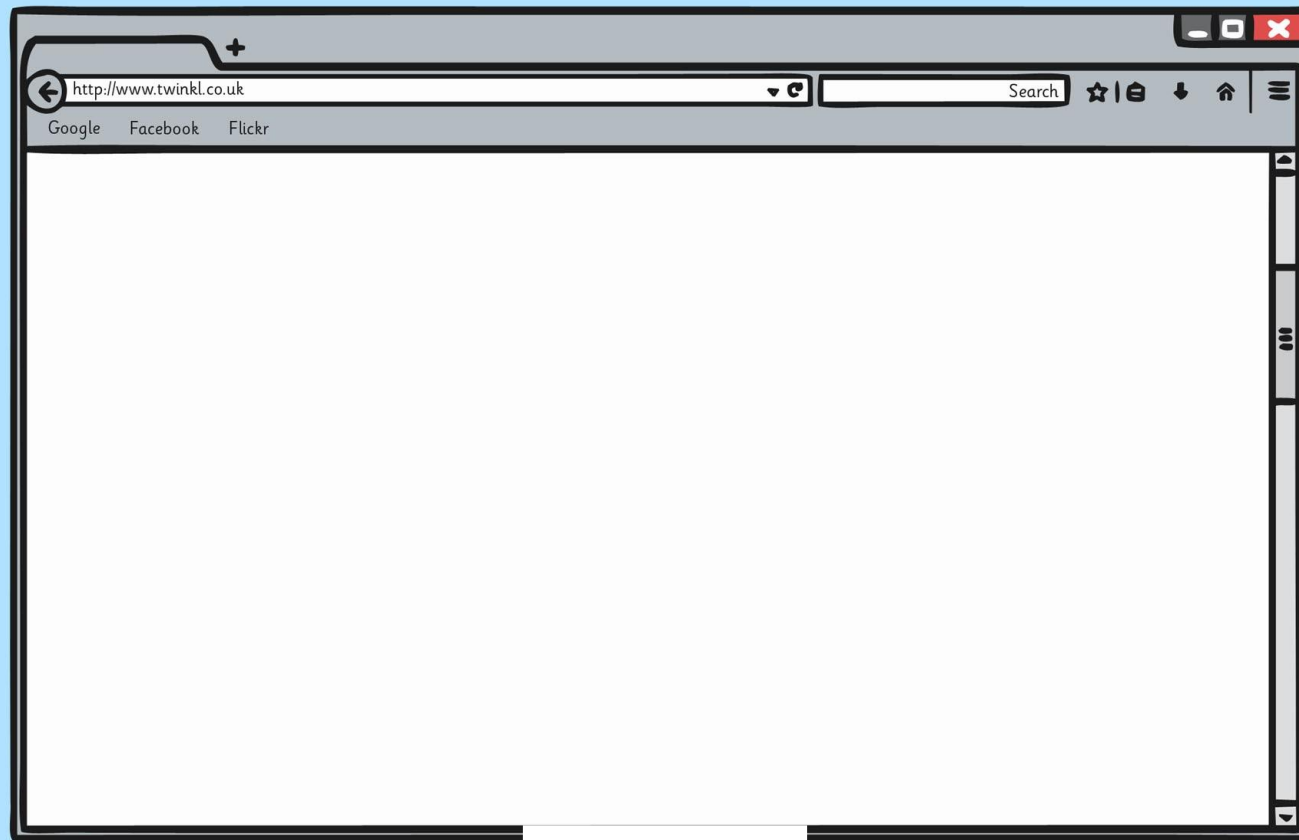

# minimise

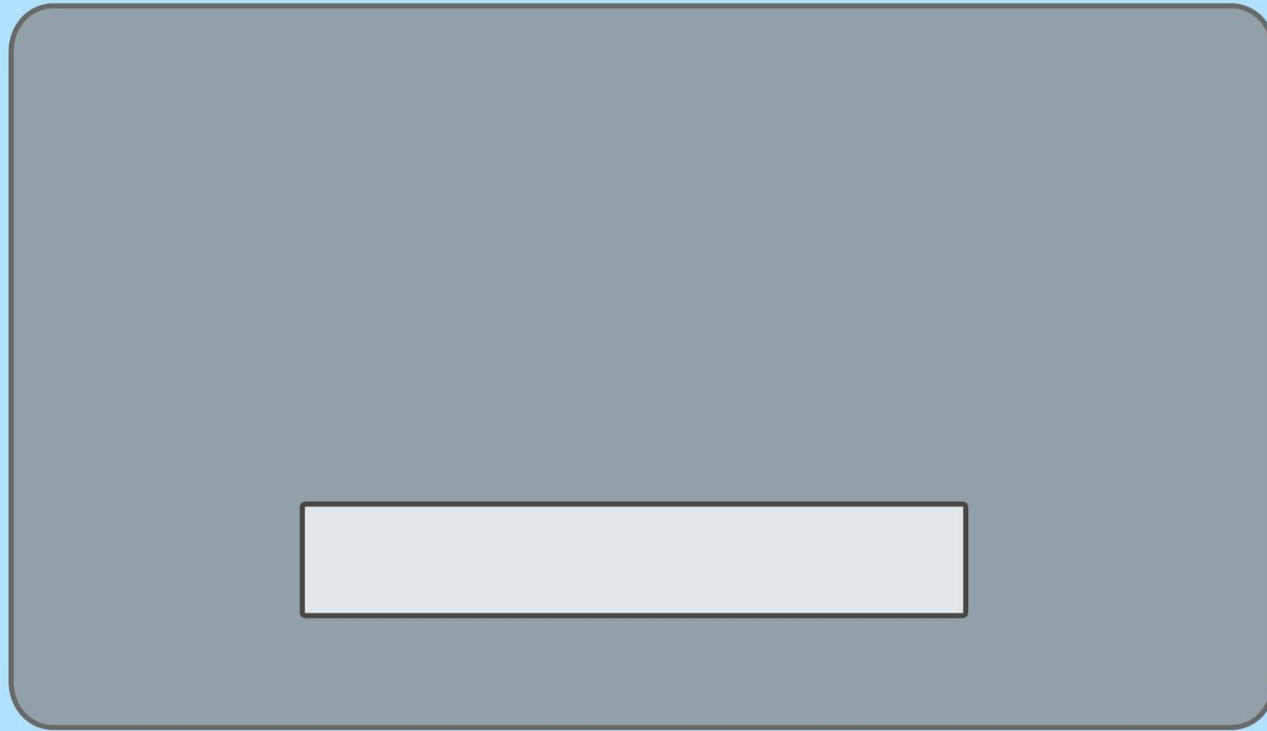

# password

Password



# screenshot

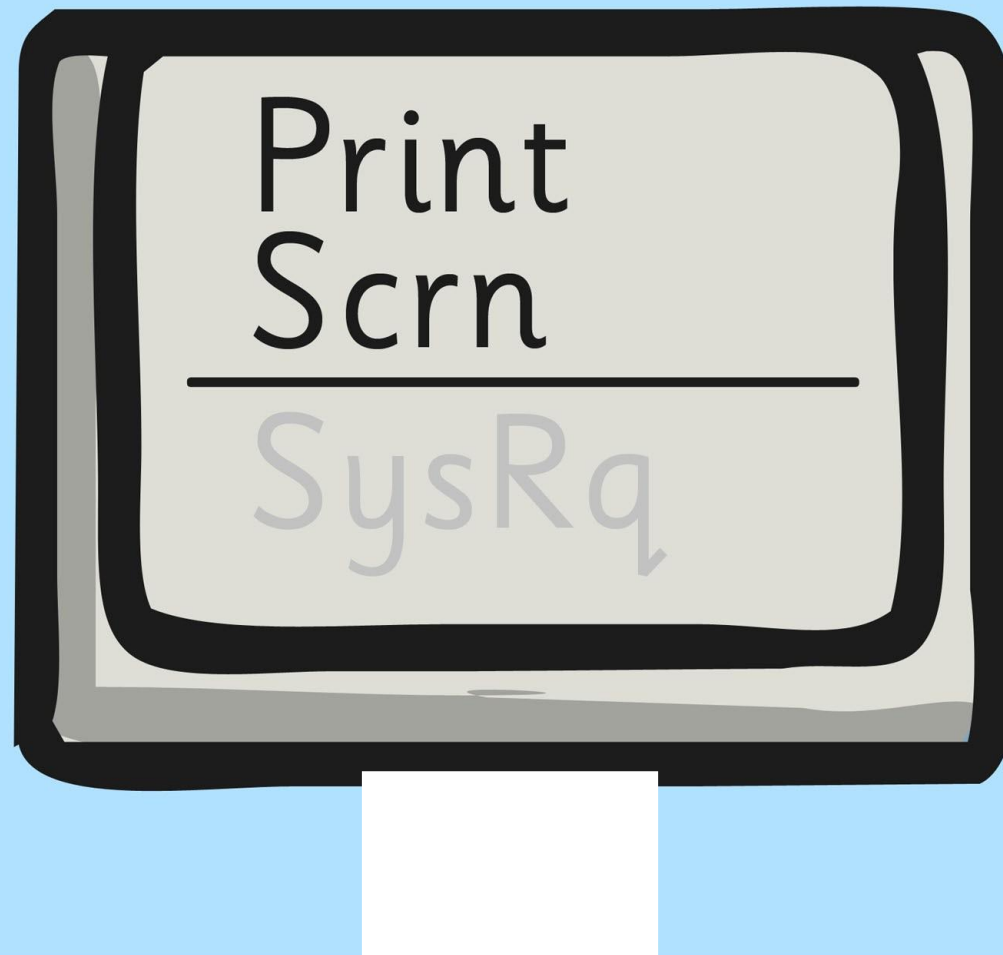

# snipping tool

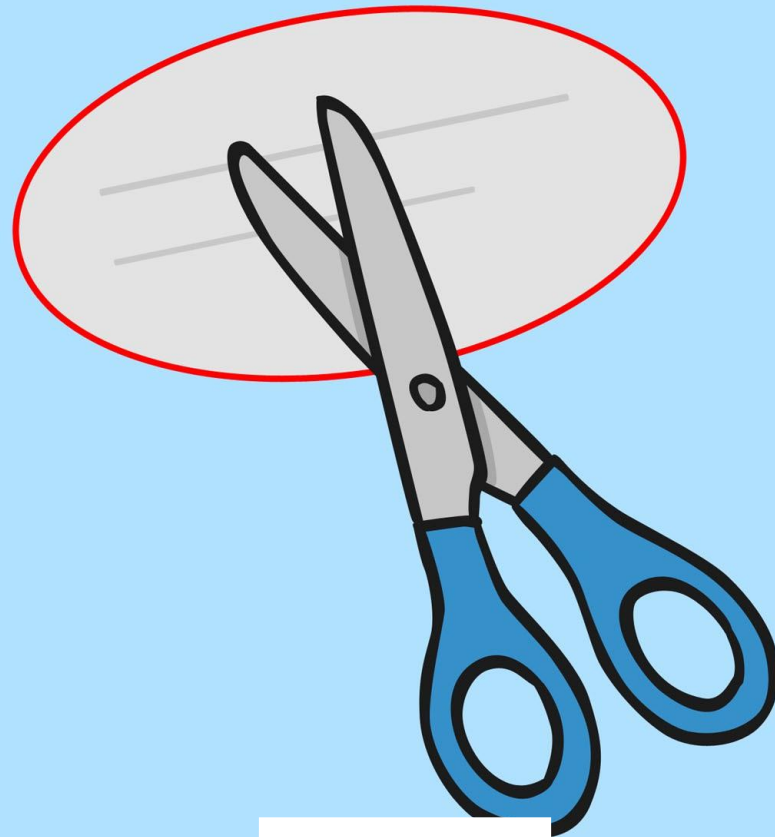

# shortcut



I can use the change case button.

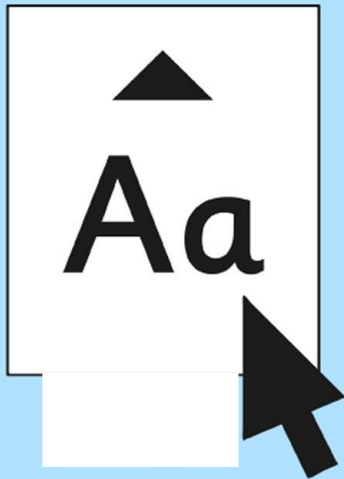

I can align text.

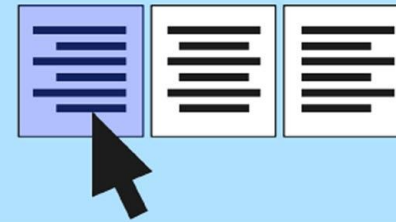

Text

I can show all characters.

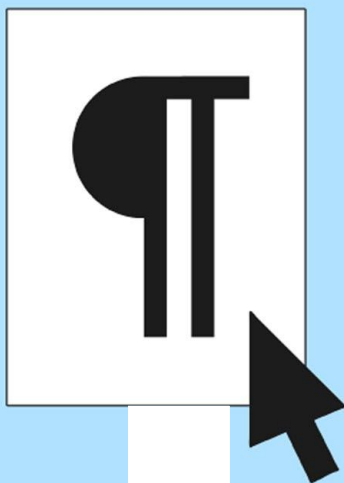

I can use menu buttons for bullet points and numbering.

- Bullet point 1
  - Bullet point 2
  - Bullet point 3
1. Number point 1
  2. Number point 2
  3. Number point 3



I can choose the format of bullet points.

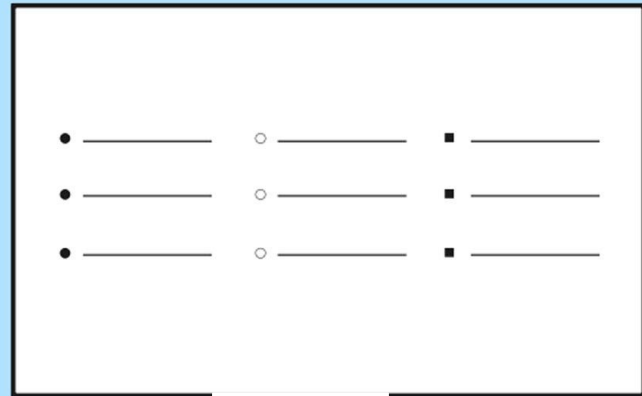

I can use the <ctrl> key.

Use



Key

I can use main keyboard shortcuts.

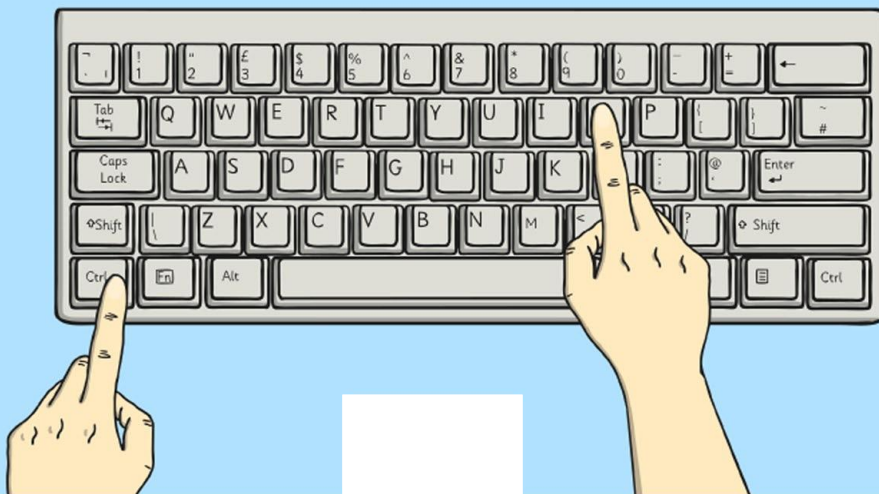

I can insert a text box.

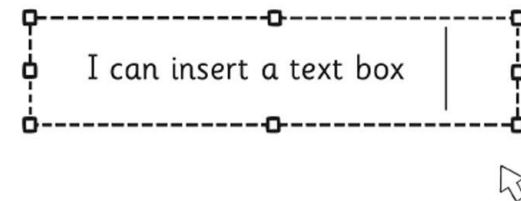

I can format a text box.

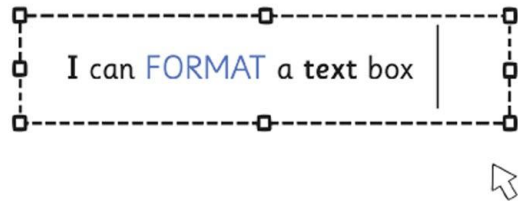

I can format how text boxes are laid out.

Text here text here text here text here text here text here text here text here text here  
text here text here text here text here text here text here text here text here text here  
text here text here text here text here text here text here text here text here text here  
text here text here text here text here text here text here text here text here text here  
text here text here text here text here text here text here text here text here text here  
text here text here text here text here text here text here text here text here text here  
text here text here text here text here text here text here text here text here text here  
text here text here text here text here text here text here text here text here text here  
Text here text here text here text here text here text here text here text here text here  
text here text here text here text here text here text here text here text here text here  
text here text here text here text here text here text here text here text here text here  
text here text here text here text here text here text here text here text here text here

**Wrap Text**

I can use the  
change case button.

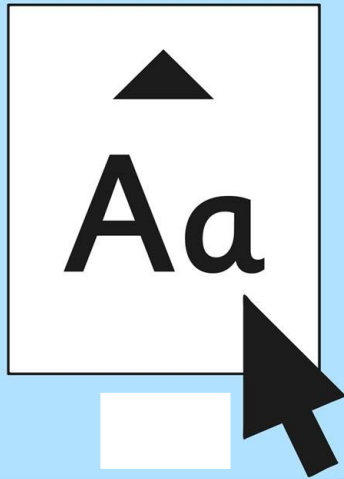

I can align text.

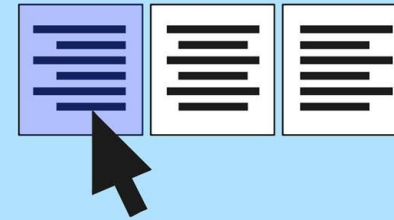

Text

I can show all characters.

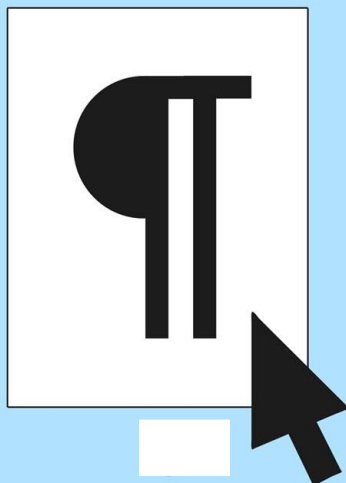

I can use menu buttons for  
bullet points and numbering.

- Bullet point 1
  - Bullet point 2
  - Bullet point 3
- 1. Number point 1
  - 2. Number point 2
  - 3. Number point 3

I can choose the format of bullet points.

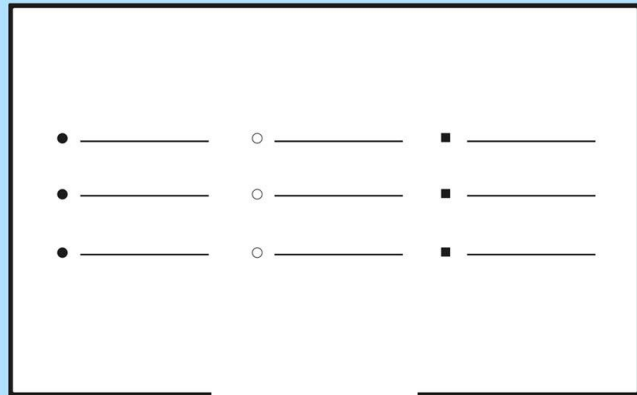

I can use the <ctrl> key.

Use



Key

I can use main keyboard shortcuts.



I can insert a text box.

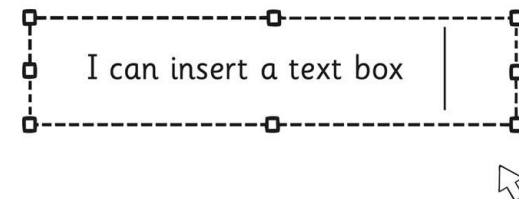

# I can format a text box.

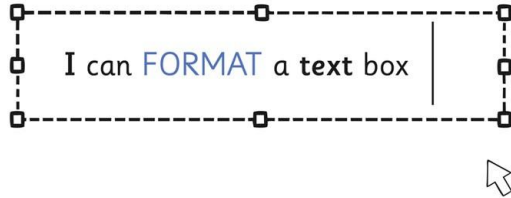

# I can format how text boxes are laid out.

Text here text here text here text here text here text here text here text here text here  
text here text here text here text here text here text here text here text here text here  
text here text here text here text here text here text here text here text here text here  
text here text here text here text here text here text here text here text here text here  
text here text here text here text here text here text here text here text here text here  
text here text here text here text here text here text here text here text here text here  
text here text here text here text here text here text here text here text here text here  
text here text here text here text here text here text here text here text here text here  
Text here text here text here text here text here text here text here text here text here  
text here text here text here text here text here text here text here text here text here  
text here text here text here text here text here text here text here text here text here  
text here text here text here text here text here text here text here text here text here

**Wrap Text**

I can use the  
change case button.

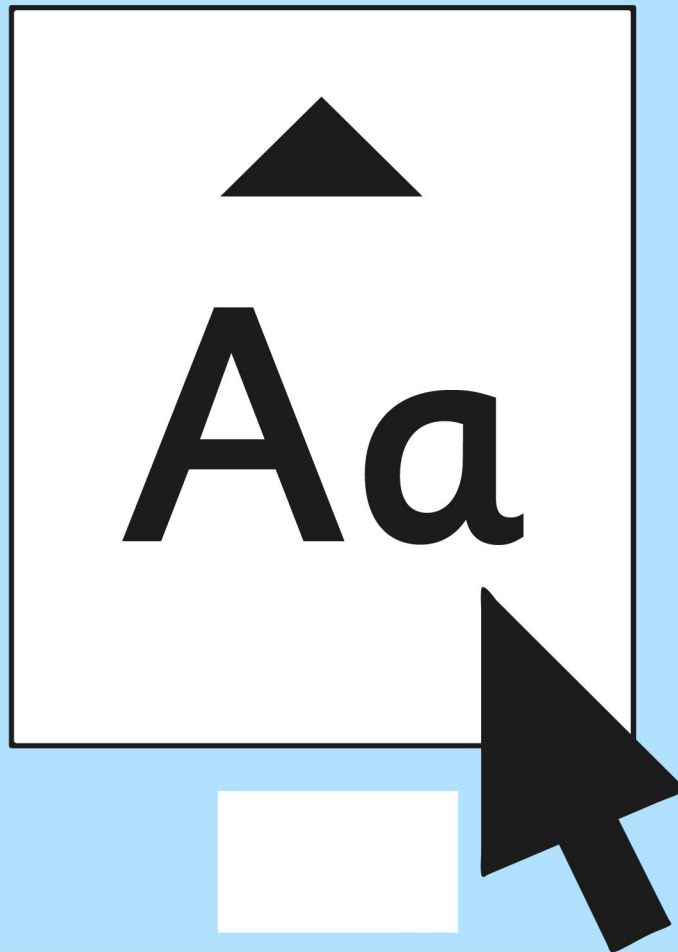

*I can align text.*



Text

*I can show all characters.*

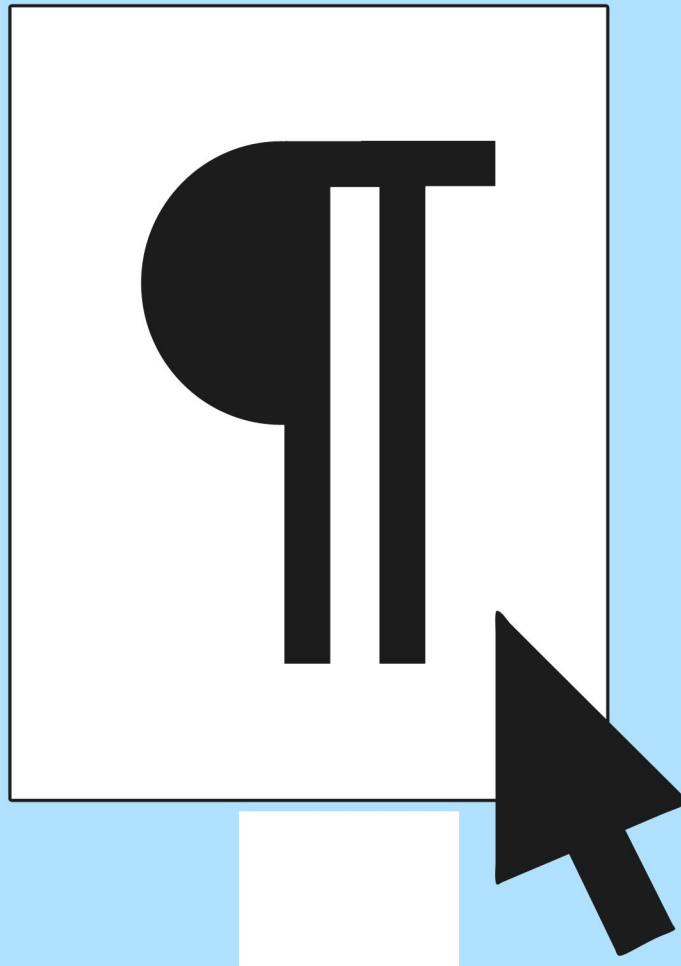



*I can use menu buttons for bullet points and numbering.*

- Bullet point 1
- Bullet point 2
- Bullet point 3

1. Number point 1
2. Number point 2
3. Number point 3

I can choose the format of bullet points.

- \_\_\_\_\_
- \_\_\_\_\_
- \_\_\_\_\_
- \_\_\_\_\_
- \_\_\_\_\_
- \_\_\_\_\_
- \_\_\_\_\_
- \_\_\_\_\_
- \_\_\_\_\_

*I can use the <ctrl> key.*

Use

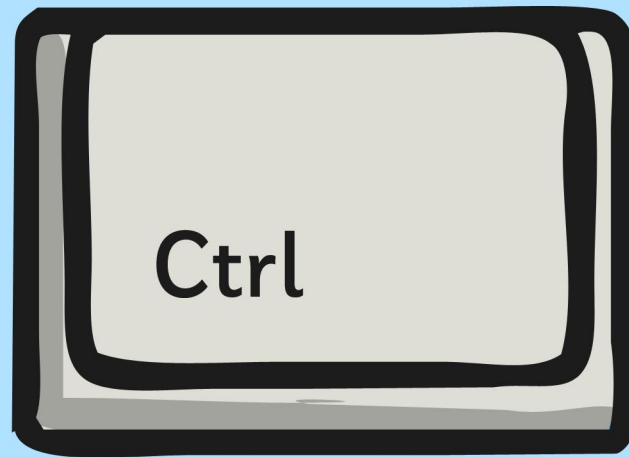

Key

*I can use main  
keyboard shortcuts.*

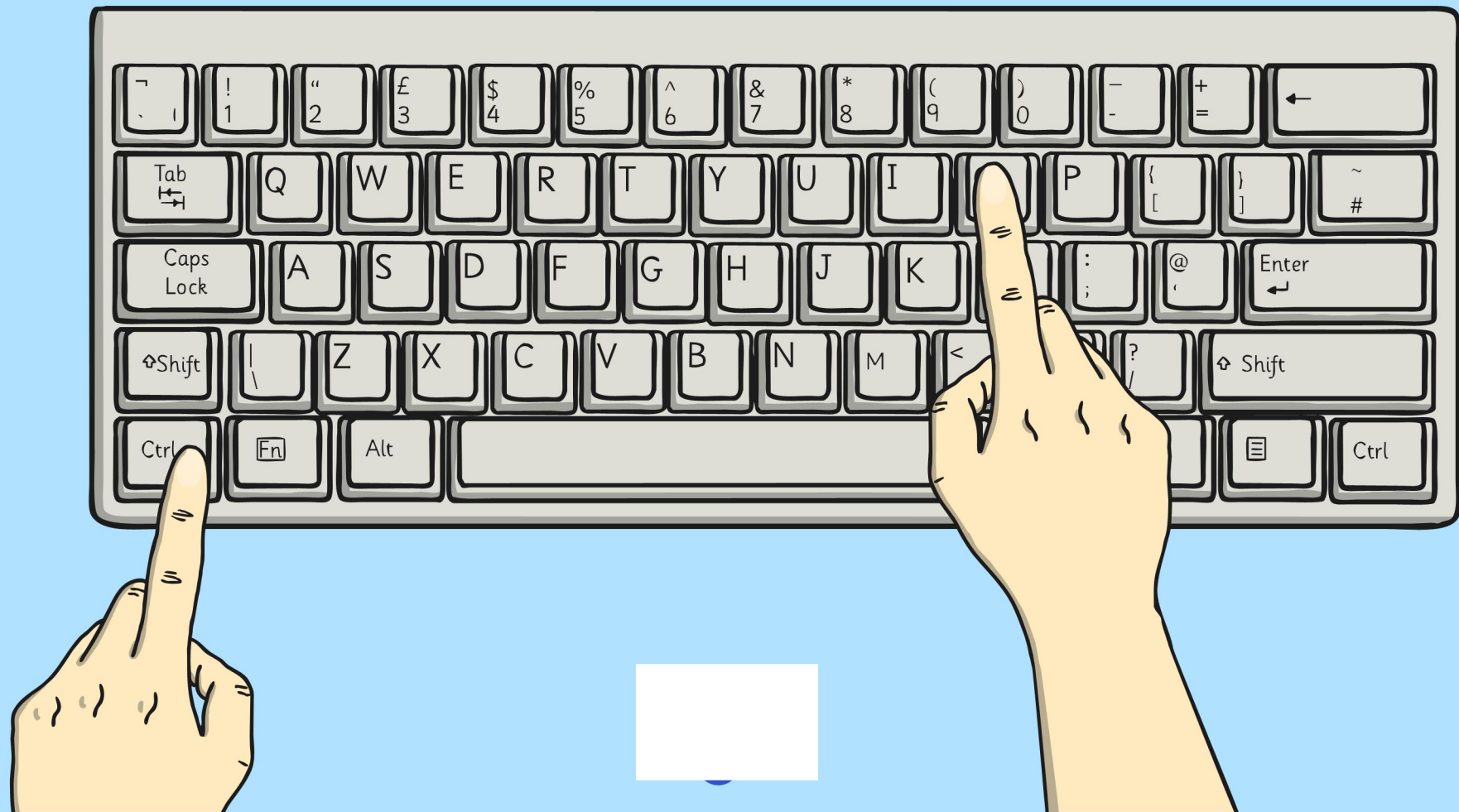

*I can insert a text box.*

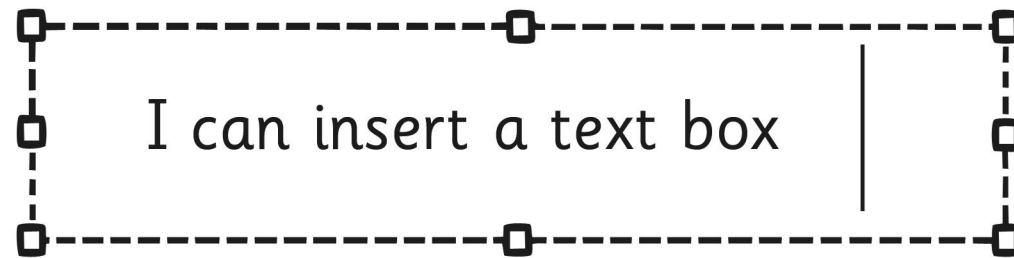

I can insert a text box

*I can format a text box.*

I can **FORMAT** a text box



*I can format how  
text boxes are laid out.*

Text here text here text here text here text here text here text here text here text here  
text here text here text here text here text here text here text here text here text here  
text here text here text here text here text here text here text here text here text here  
text here text here text here text here text here text here text here text here text here

text here text here text here  
text here text here text here  
text here text here text here  
text here text here text here  
text here text here text here  
text here text here text here  
text here text here text here

## Wrap Text

text here text here text here  
text here text here text here  
text here text here text here  
text here text here text here  
text here text here text here  
text here text here text here  
text here text here text here

Text here text here text here text here text here text here text here text here text here  
text here text here text here text here text here text here text here text here text here  
text here text here text here text here text here text here text here text here text here  
text here text here text here text here text here text here text here text here text here

I can use the  
change case button.

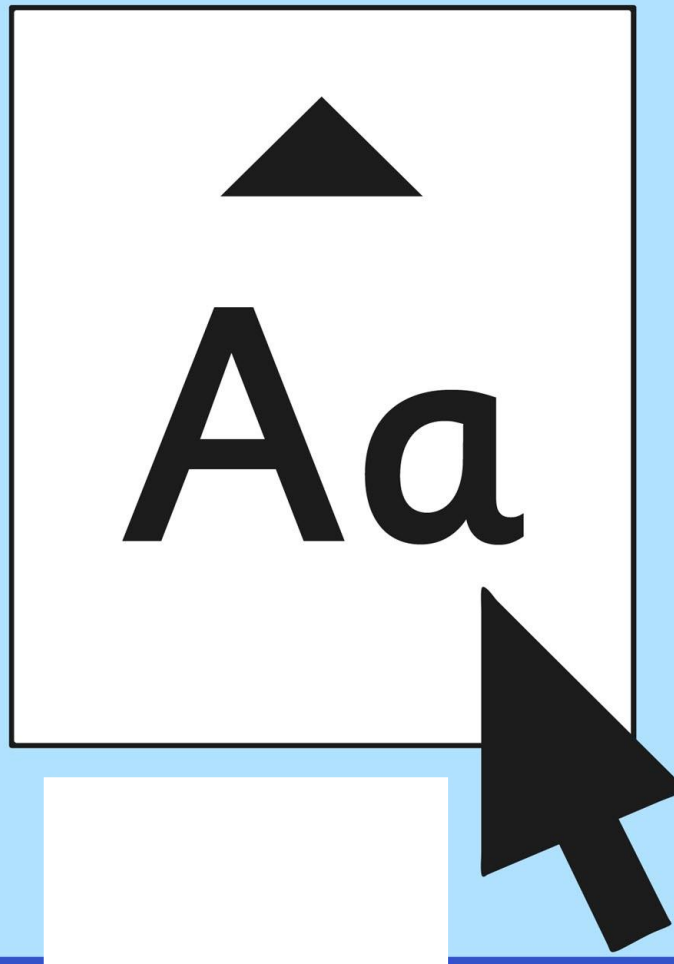



# I can align text.



Text

I can show all characters.

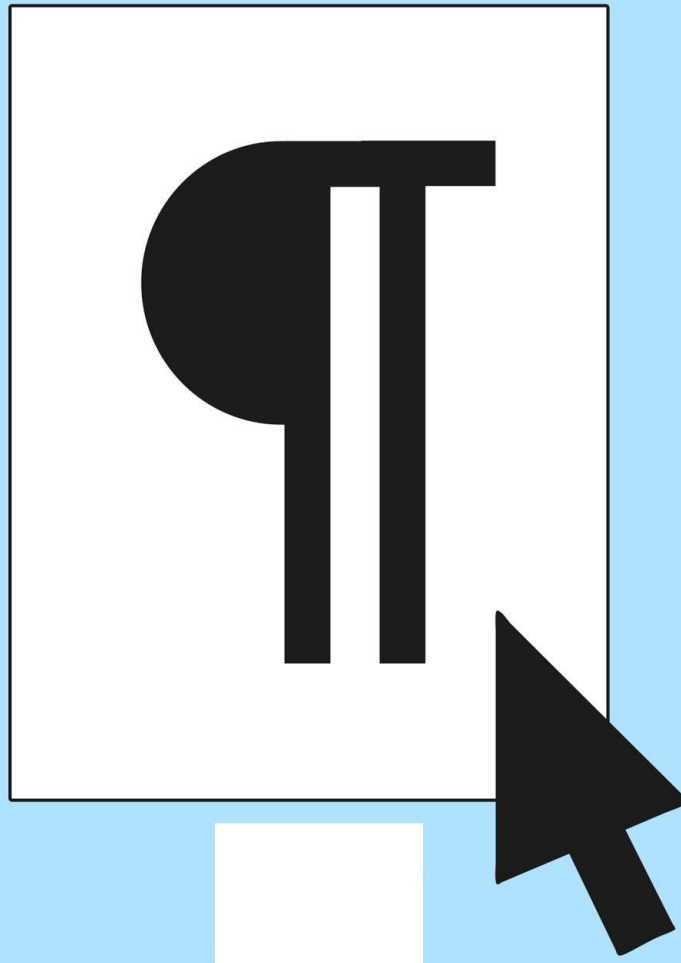

# I can use menu buttons for bullet points and numbering.

- Bullet point 1
- Bullet point 2
- Bullet point 3

1. Number point 1
2. Number point 2
3. Number point 3

I can choose the  
format of bullet points.

- |         |         |         |
|---------|---------|---------|
| ● _____ | ○ _____ | ■ _____ |
| ● _____ | ○ _____ | ■ _____ |
| ● _____ | ○ _____ | ■ _____ |

I can use the <ctrl> key.

Use



Key

I can use main keyboard shortcuts.



# I can insert a text box.

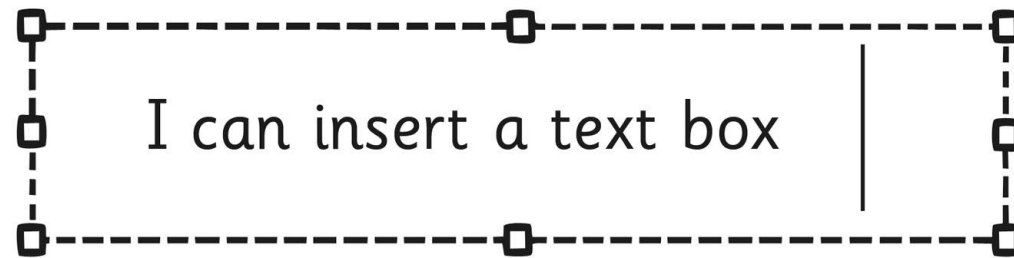

I can insert a text box



# I can format a text box.



I can **FORMAT** a text box





# I can format how text boxes are laid out.

Text here text here text here text here text here text here text here text here text here  
text here text here text here text here text here text here text here text here text here  
text here text here text here text here text here text here text here text here text here  
text here text here text here text here text here text here text here text here text here

text here text here text here  
text here text here text here  
text here text here text here  
text here text here text here  
text here text here text here  
text here text here text here  
text here text here text here

## Wrap Text

text here text here text here  
text here text here text here  
text here text here text here  
text here text here text here  
text here text here text here  
text here text here text here  
text here text here text here

Text here text here text here text here text here text here text here text here text here  
text here text here text here text here text here text here text here text here text here  
text here text here text here text here text here text here text here text here text here  
text here text here text here text here text here text here text here text here text here



Insert Text Here...





Insert Text Here...

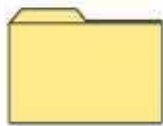
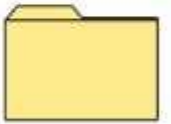
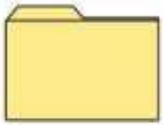

Insert Text Here...

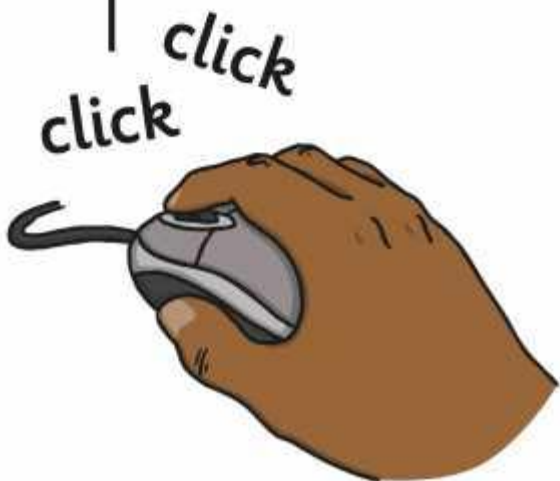

Insert Text Here...



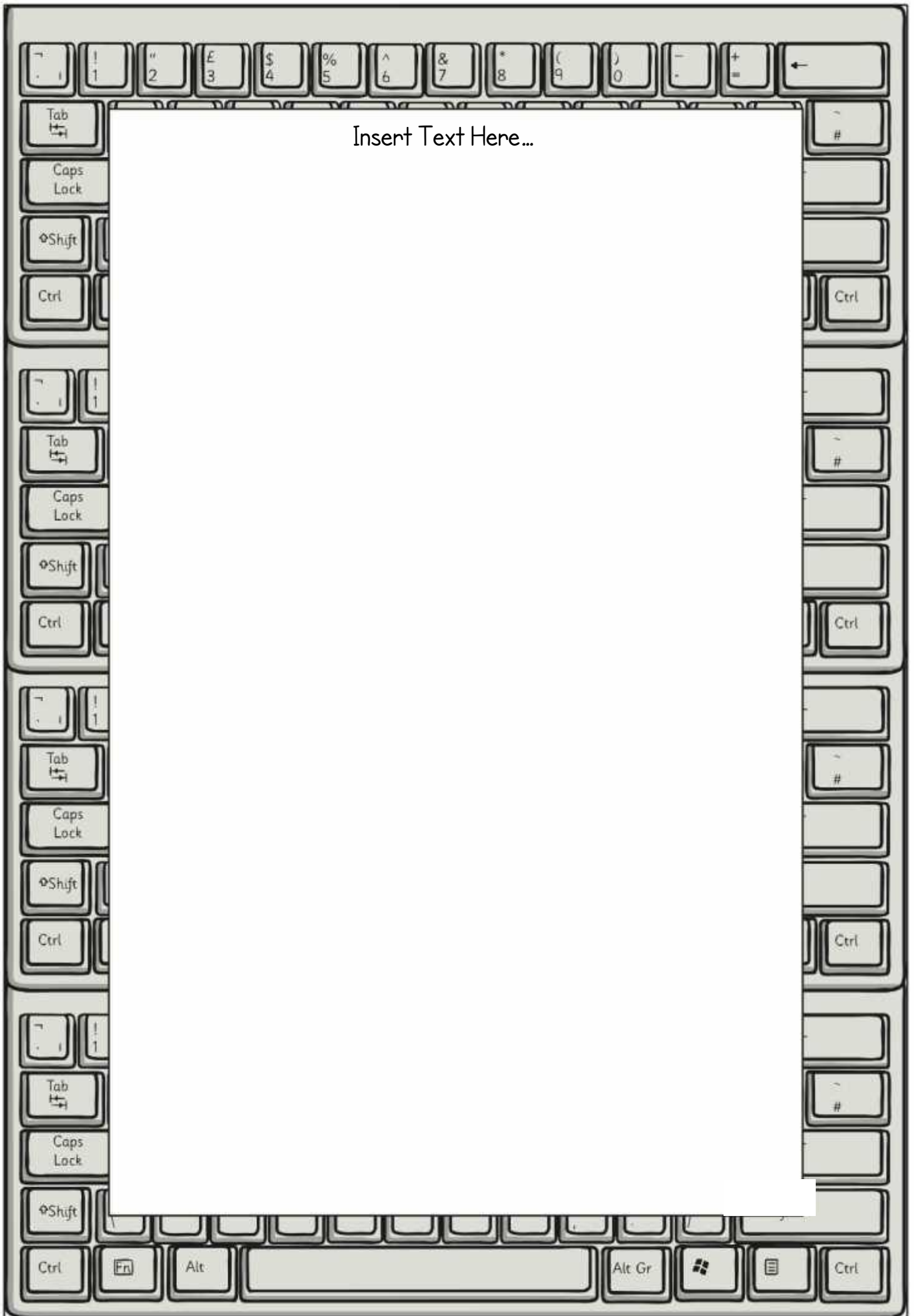

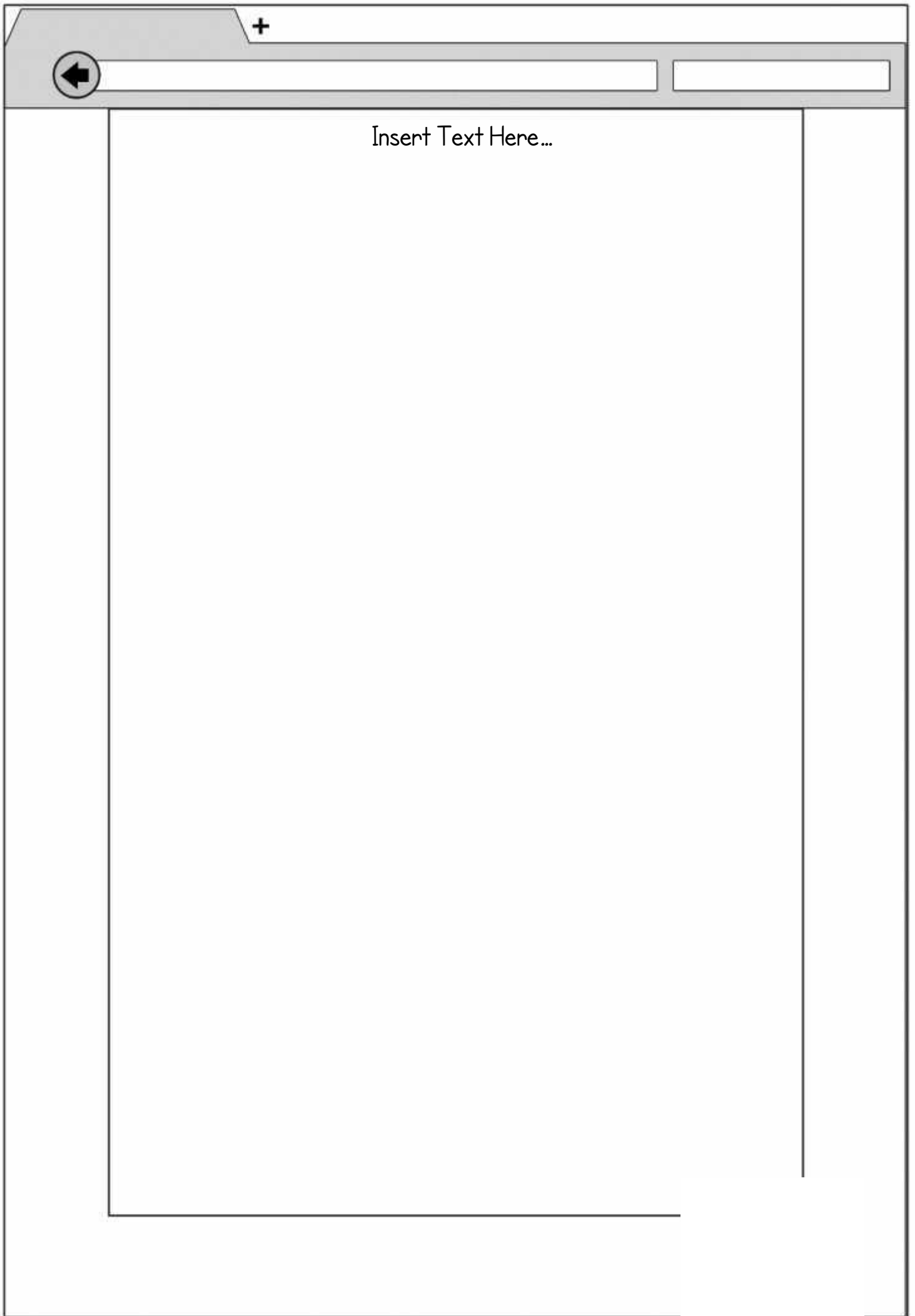

Insert Text Here...

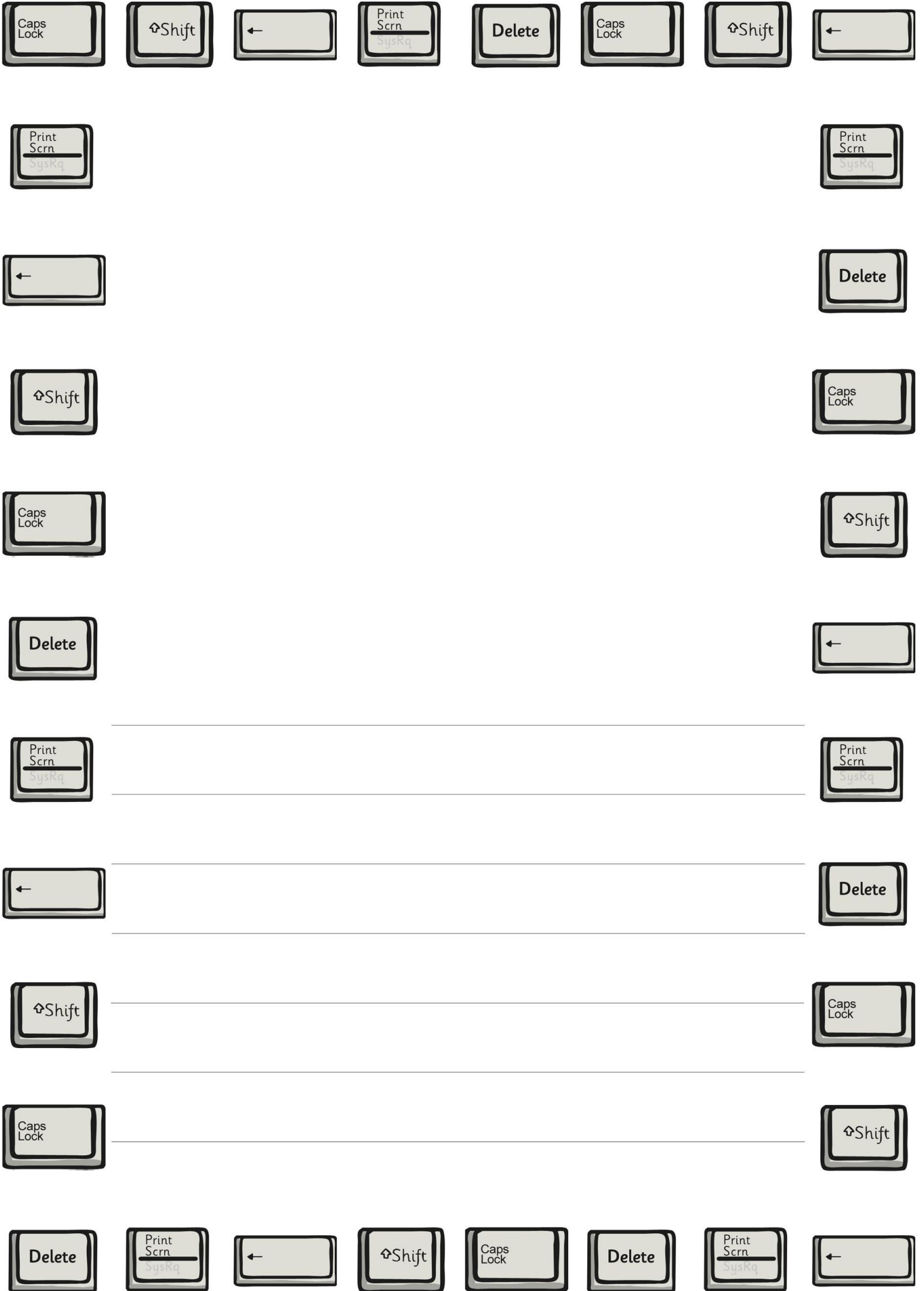



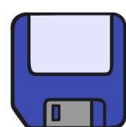
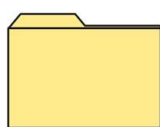
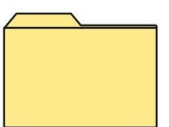
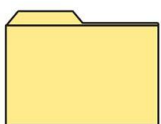
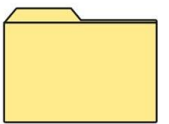
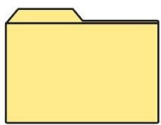

A large rectangular frame containing several horizontal lines for writing.

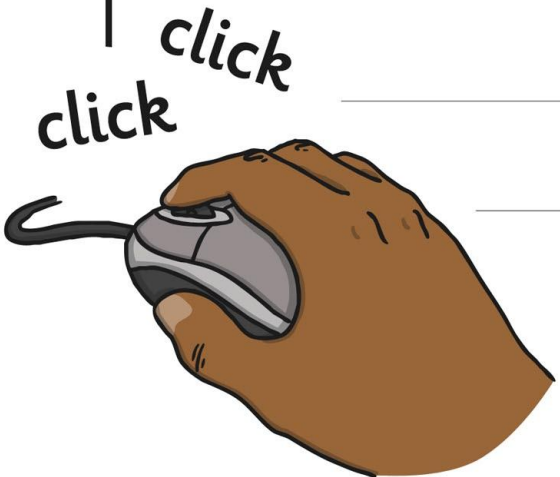

A large rectangular frame with a black border, containing a series of horizontal lines for writing. The lines are spaced evenly and extend across most of the width of the frame.

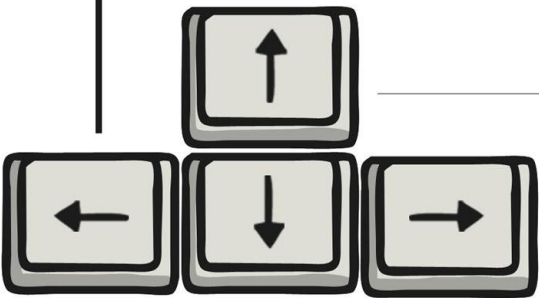

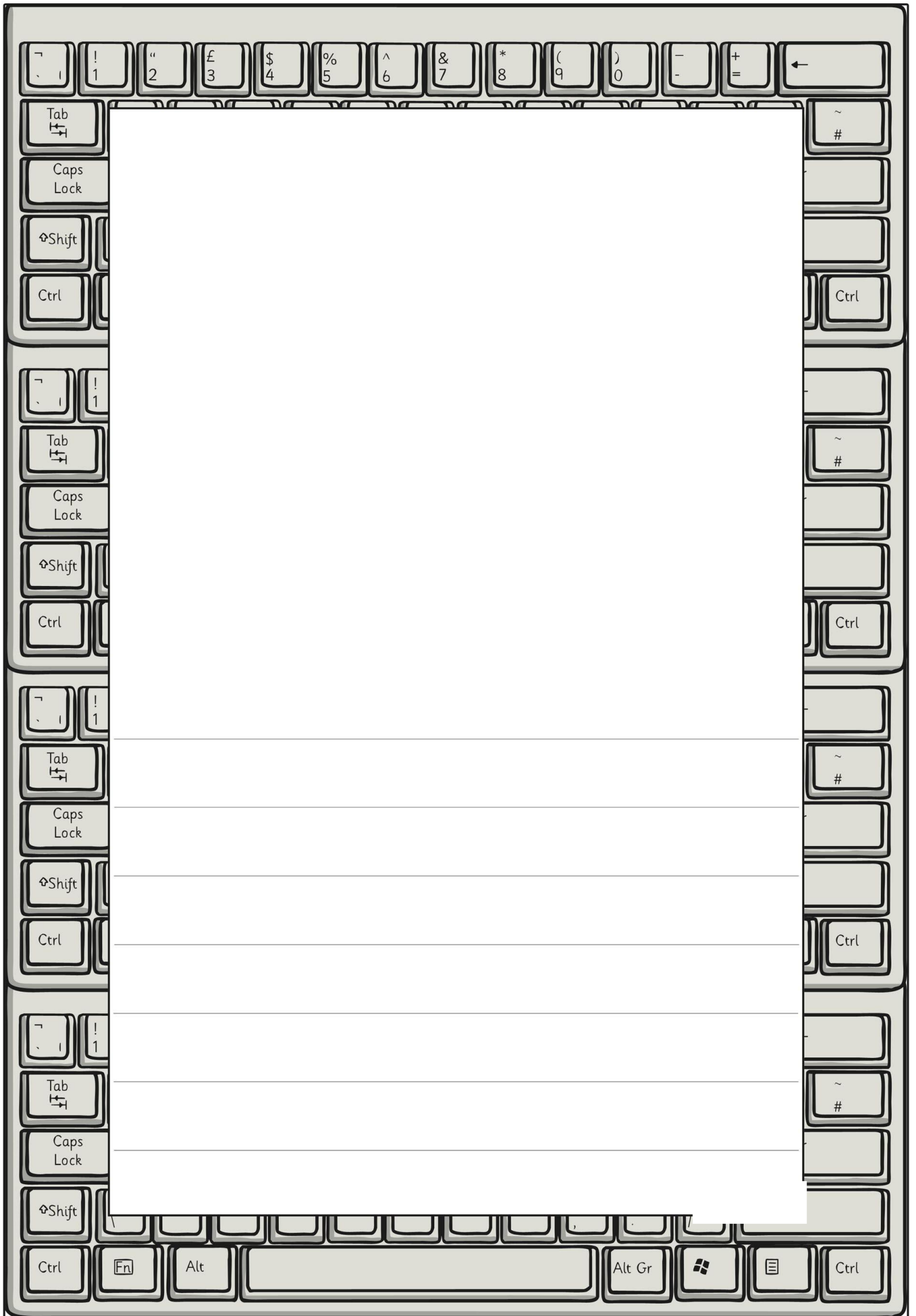

---

---

---

---

---

---

---

---

---

---

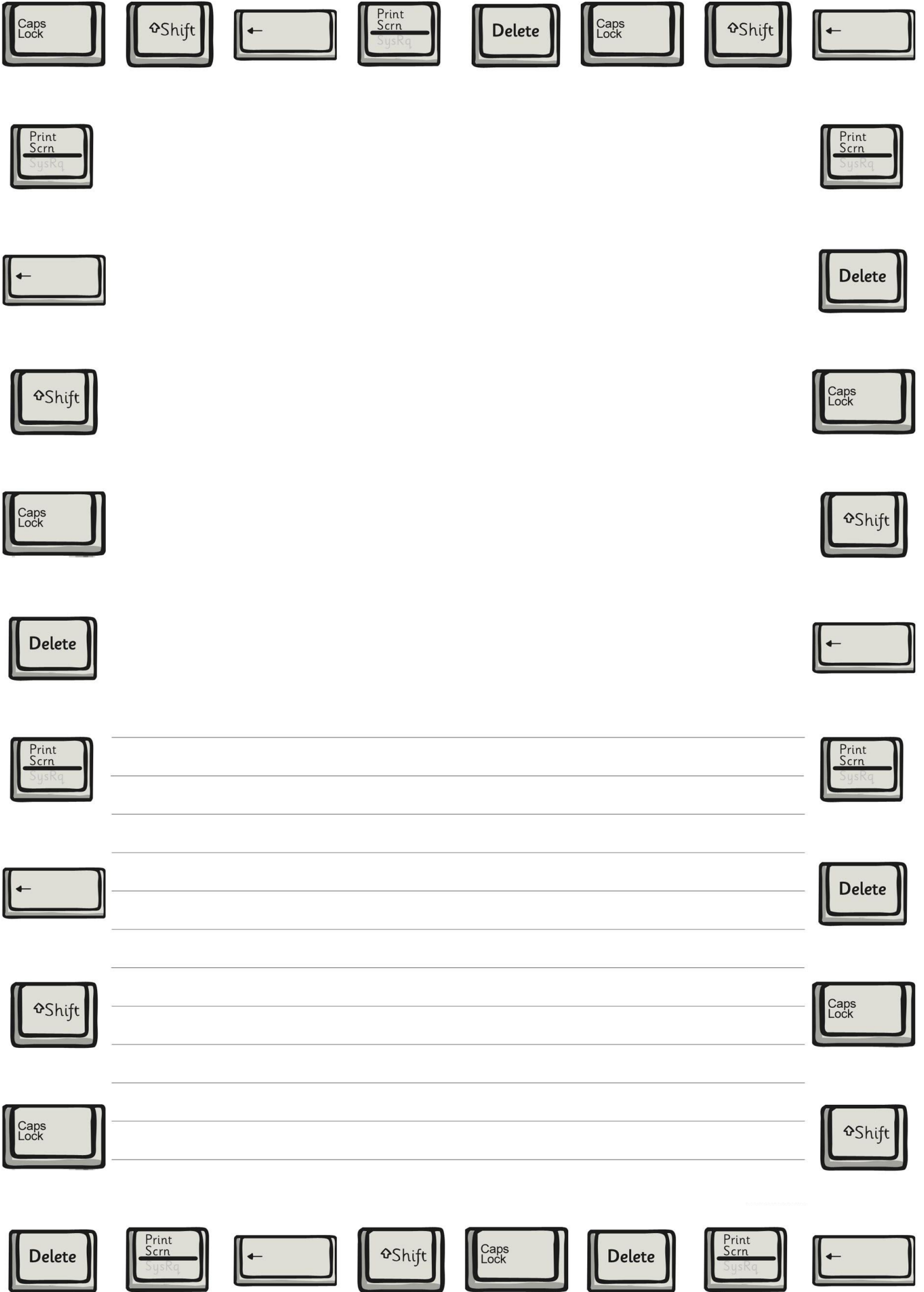

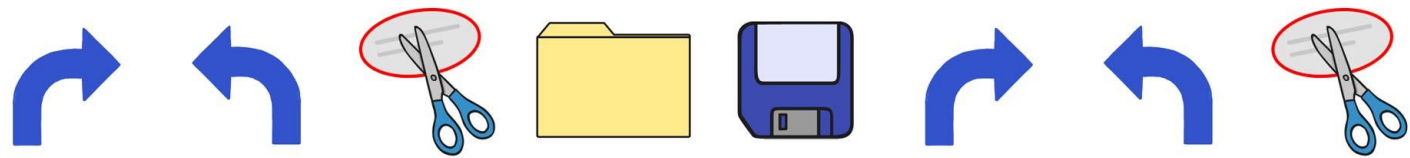
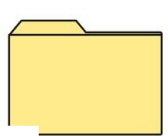
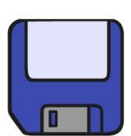
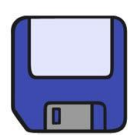
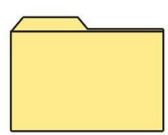
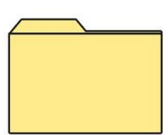
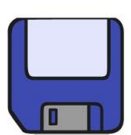
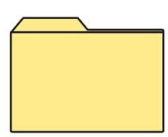
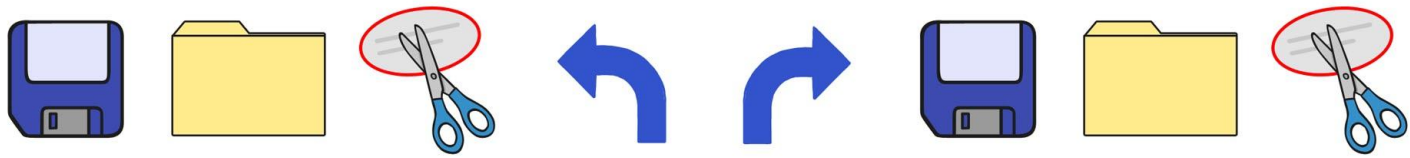

A large rectangular frame containing ten horizontal lines for writing.

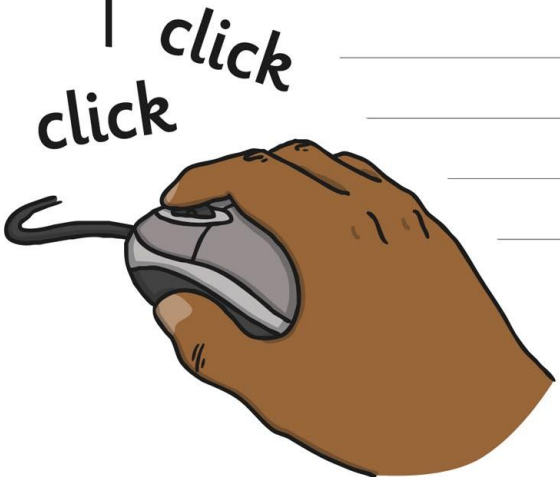



A large rectangular frame with a black border, containing a series of horizontal lines for writing. The lines are evenly spaced and extend across most of the width of the frame.

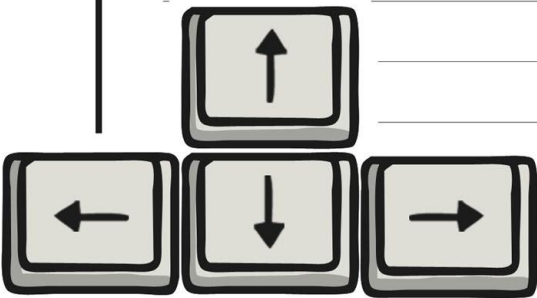

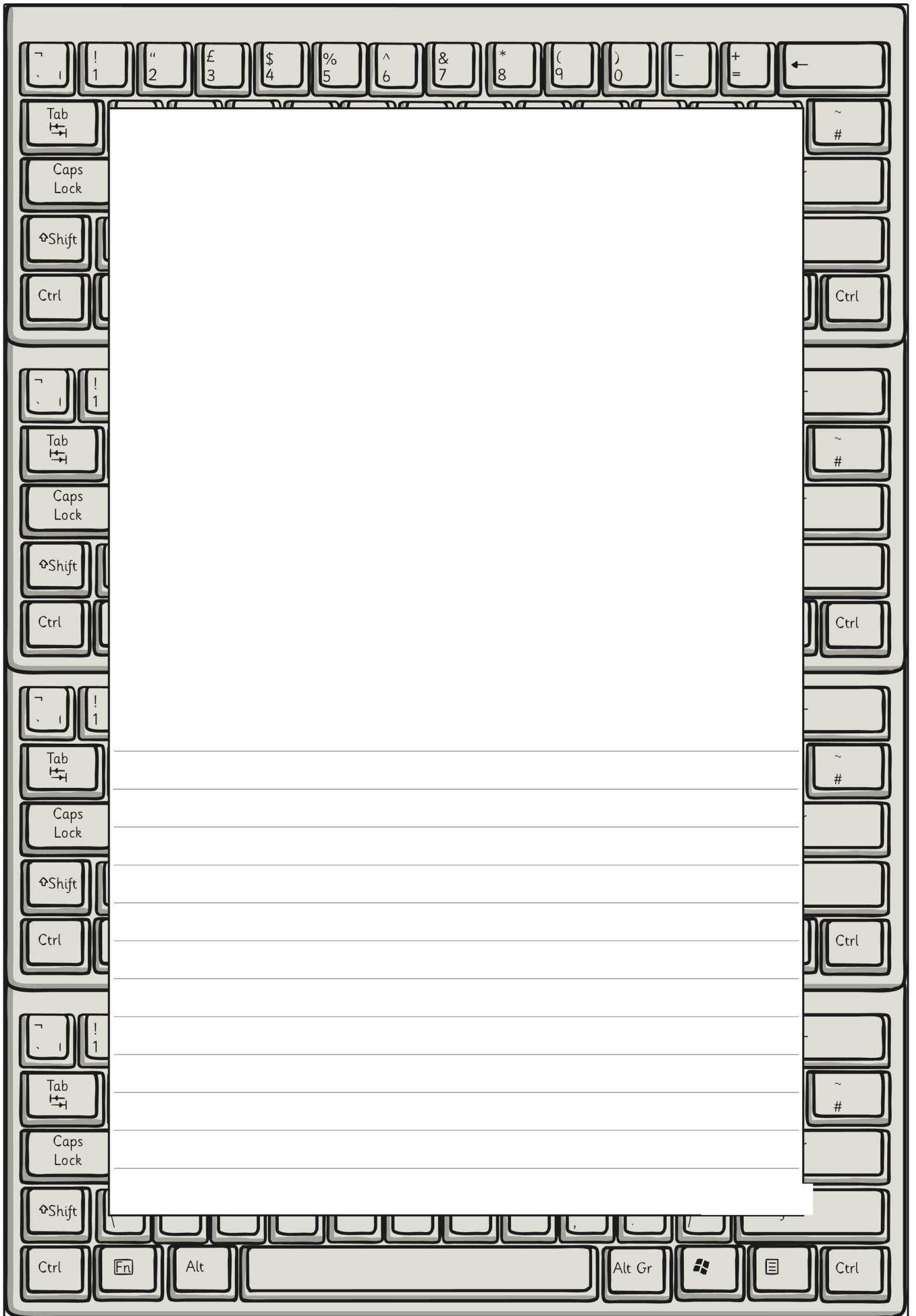



A large, empty rectangular area with a thin black border, occupying the upper half of the page. It is intended for a drawing or a free-form response.

A series of horizontal lines for writing, consisting of 15 evenly spaced lines within a rectangular frame. This area is designed for a structured written response.

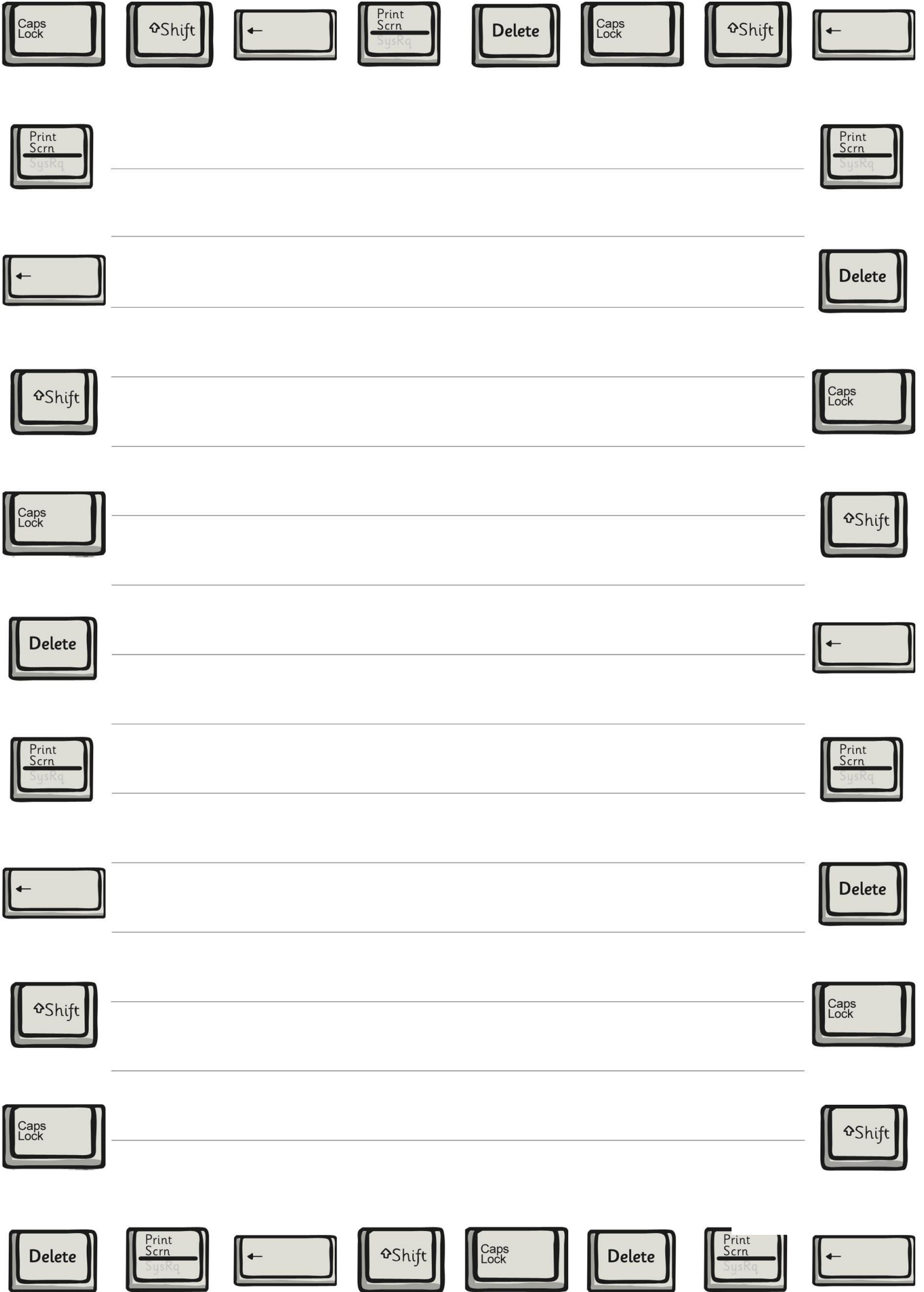

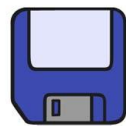
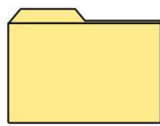
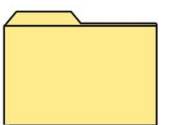
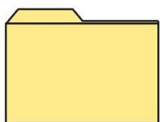
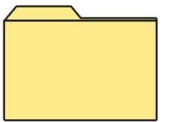
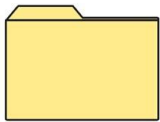

Lined writing area with 15 horizontal lines.

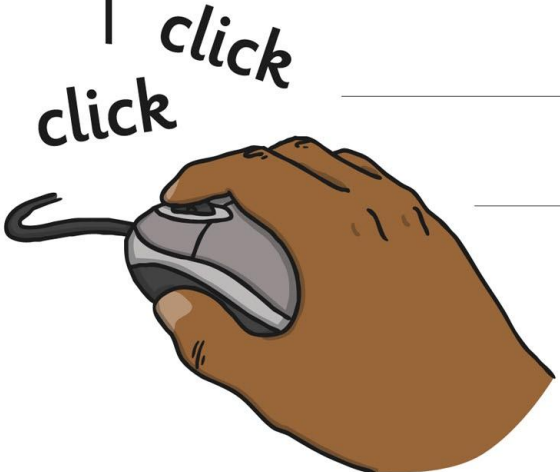

A large rectangular frame containing 20 horizontal lines for writing.

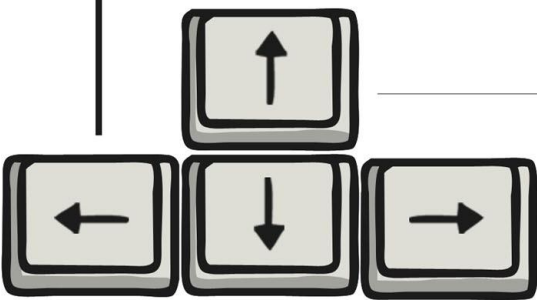

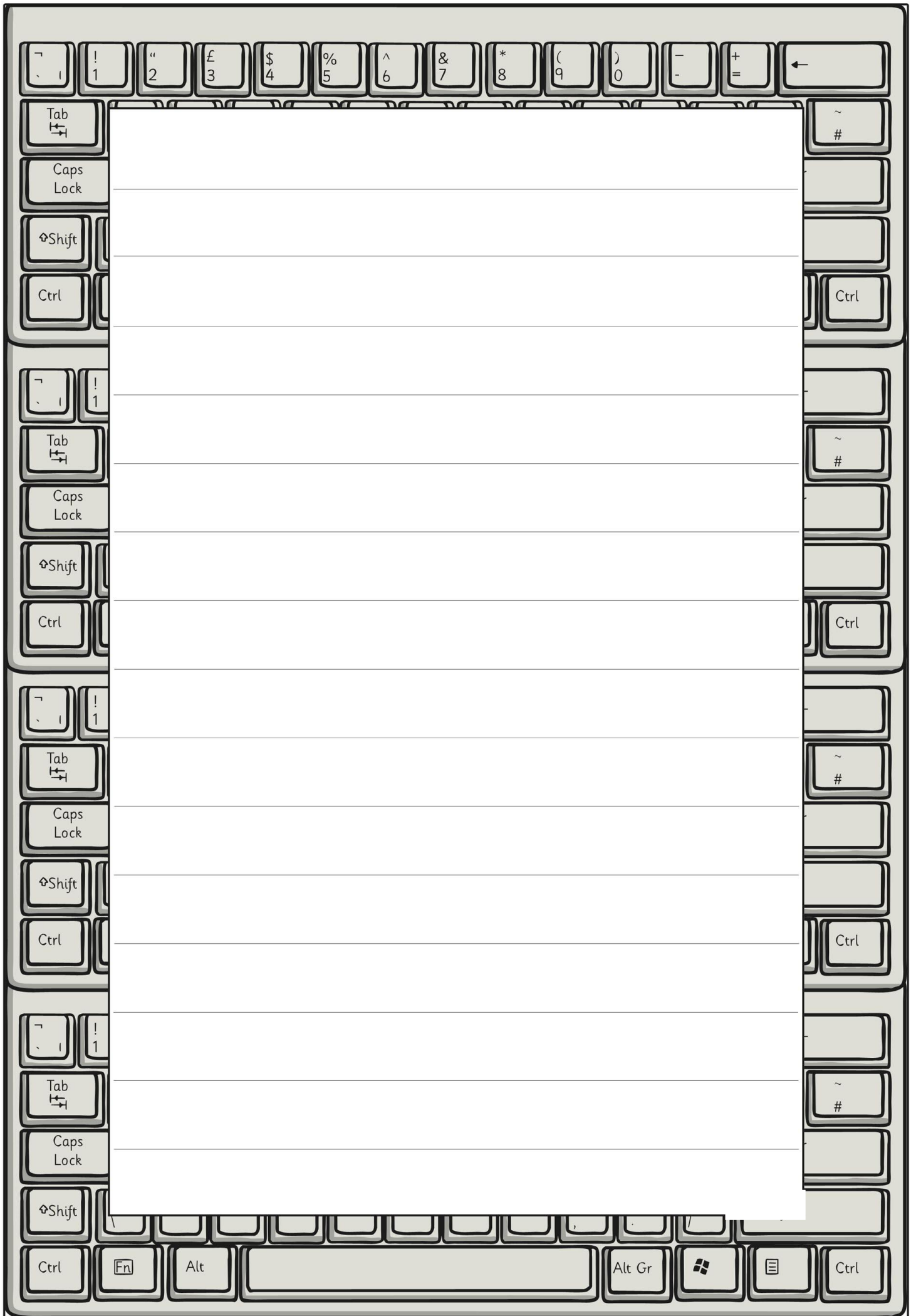





A large rectangular area with horizontal lines, intended for writing or drawing.

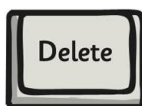
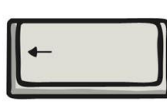
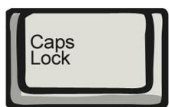
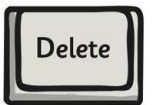
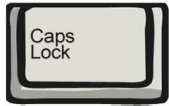
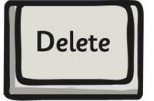

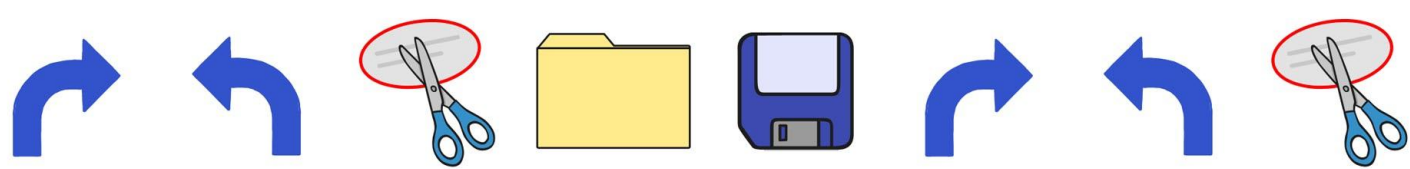
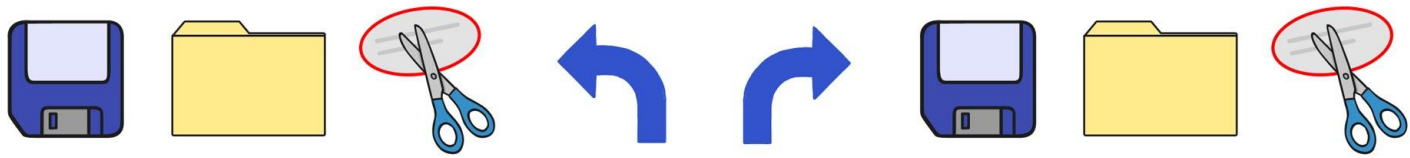

Lined writing area with 25 horizontal lines.

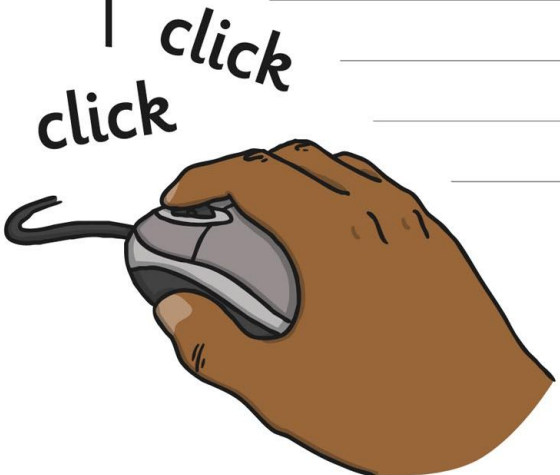

A large rectangular area with a black border, containing 25 horizontal lines for writing.

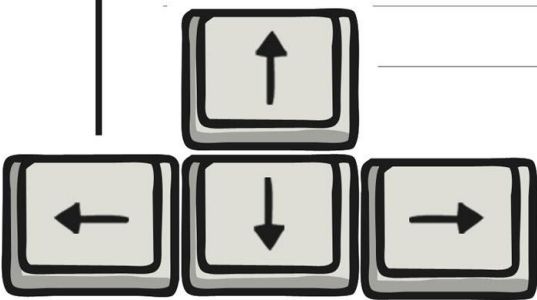

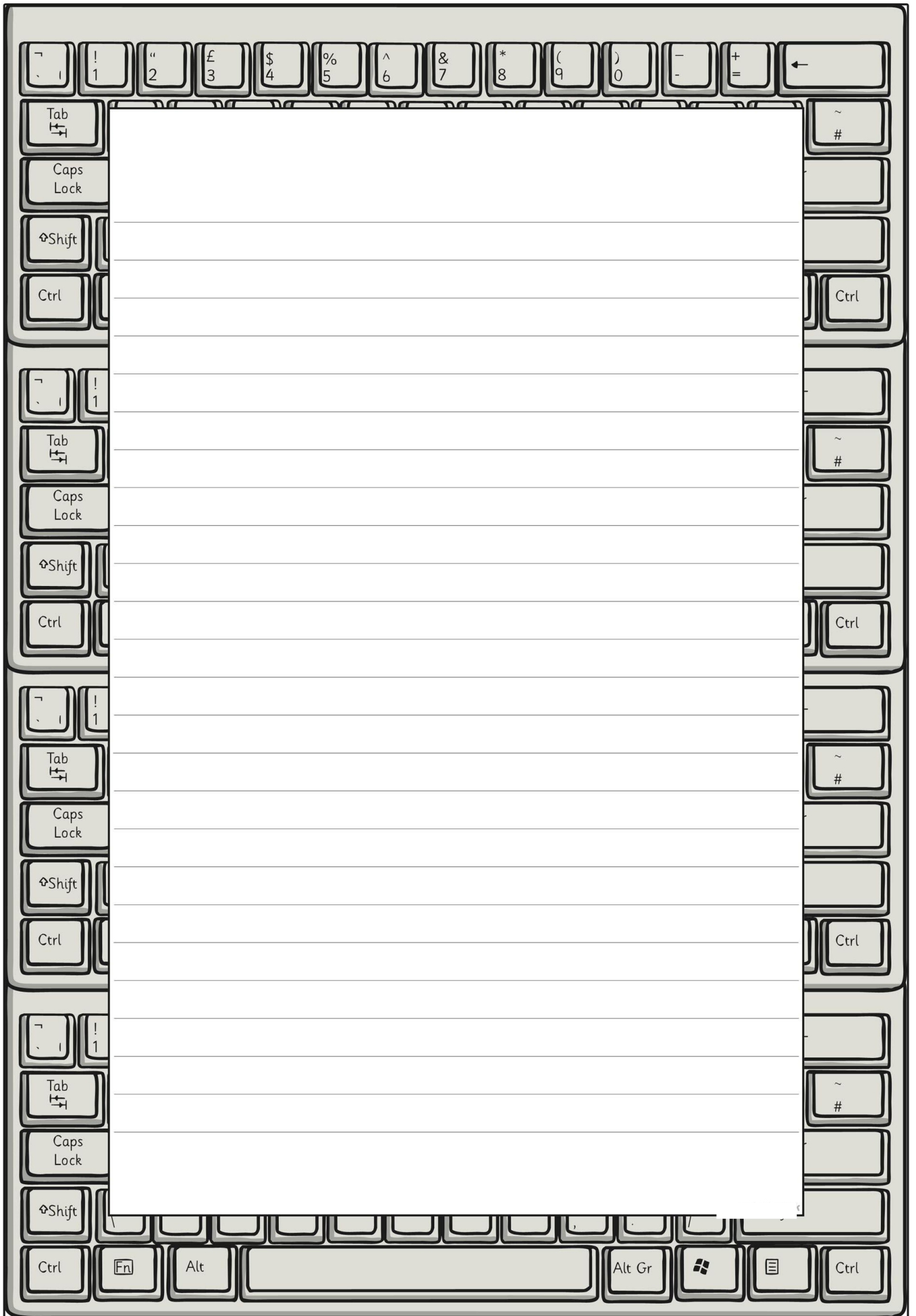



A large rectangular area with horizontal lines, intended for writing or taking notes.

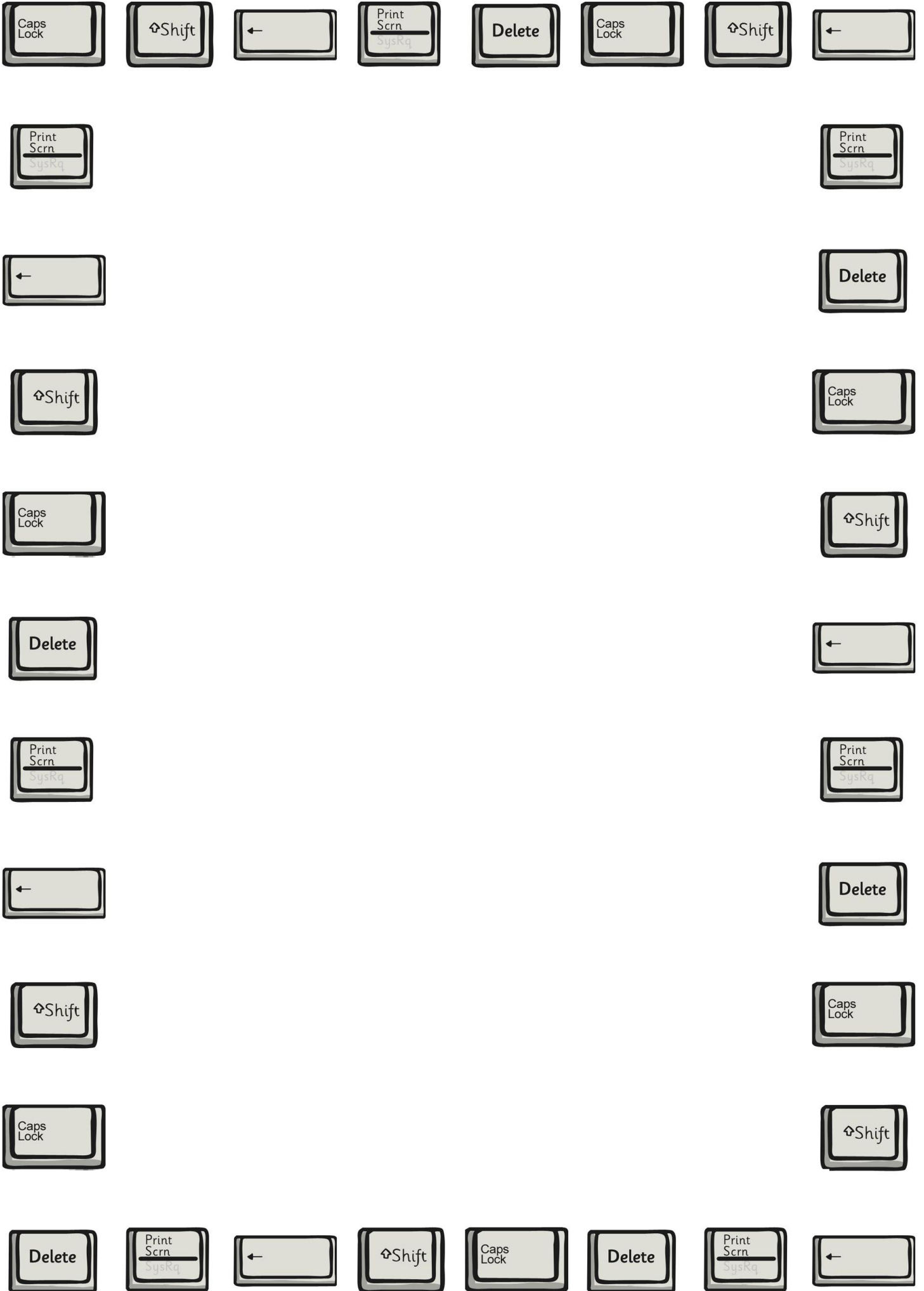



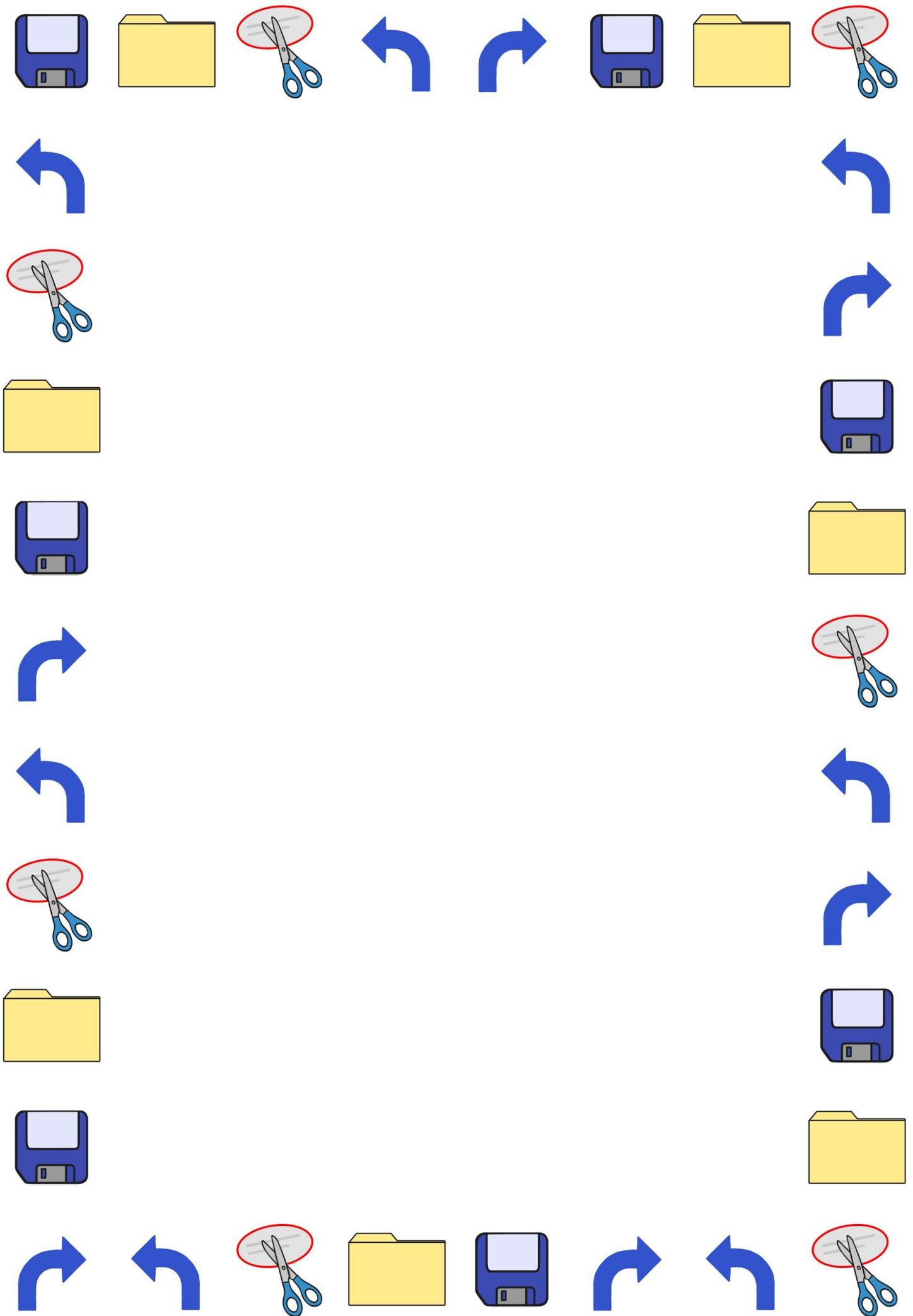

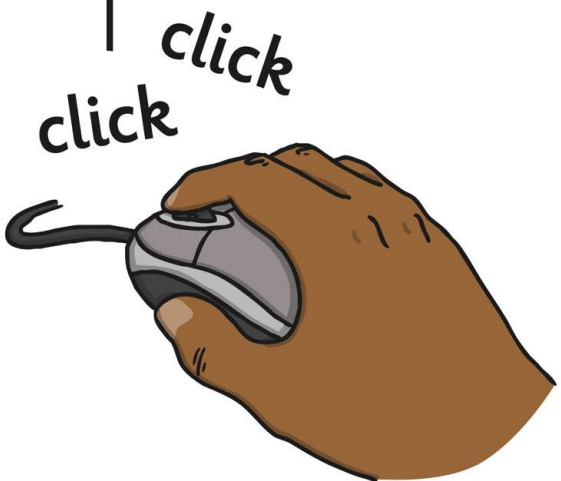

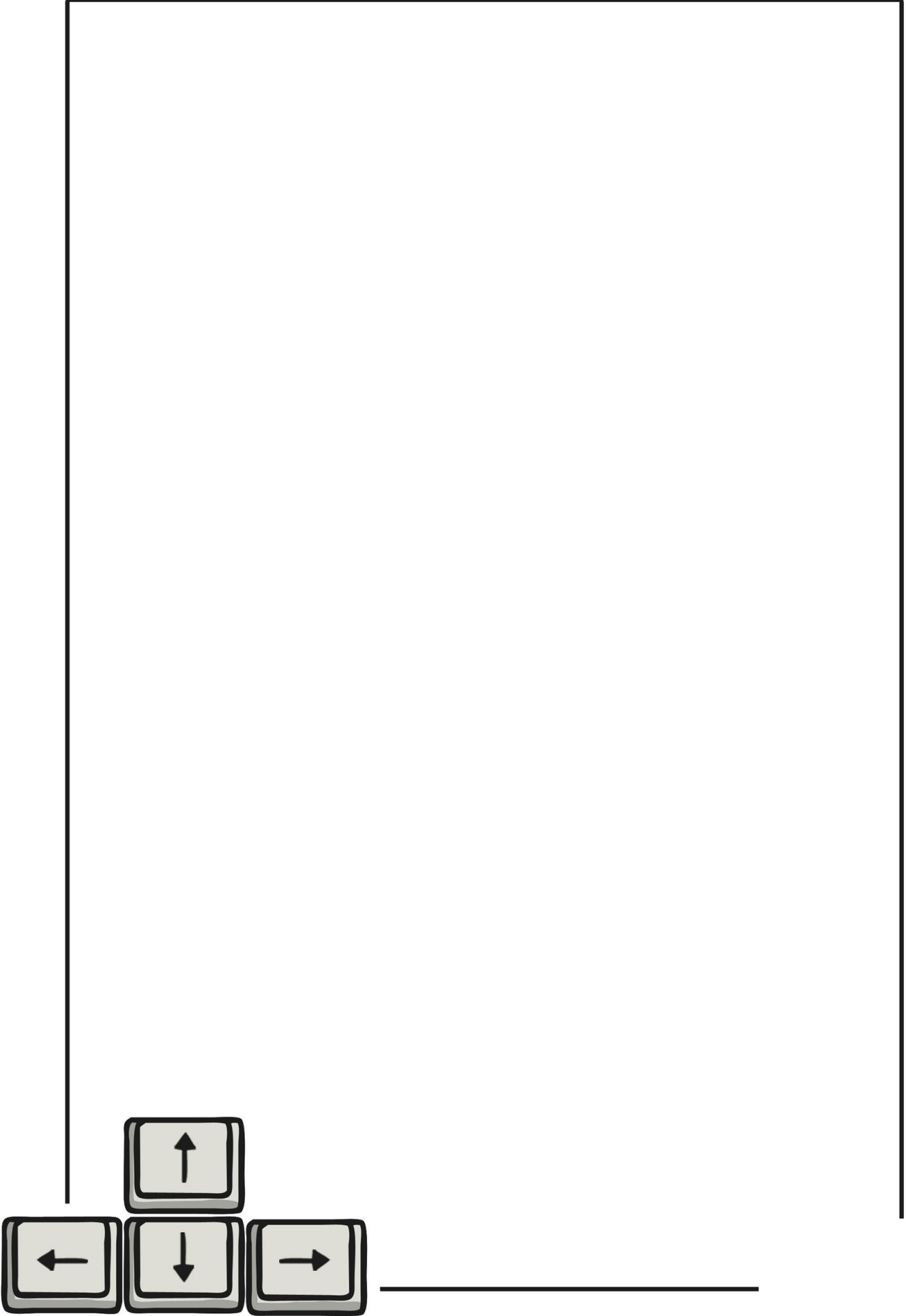

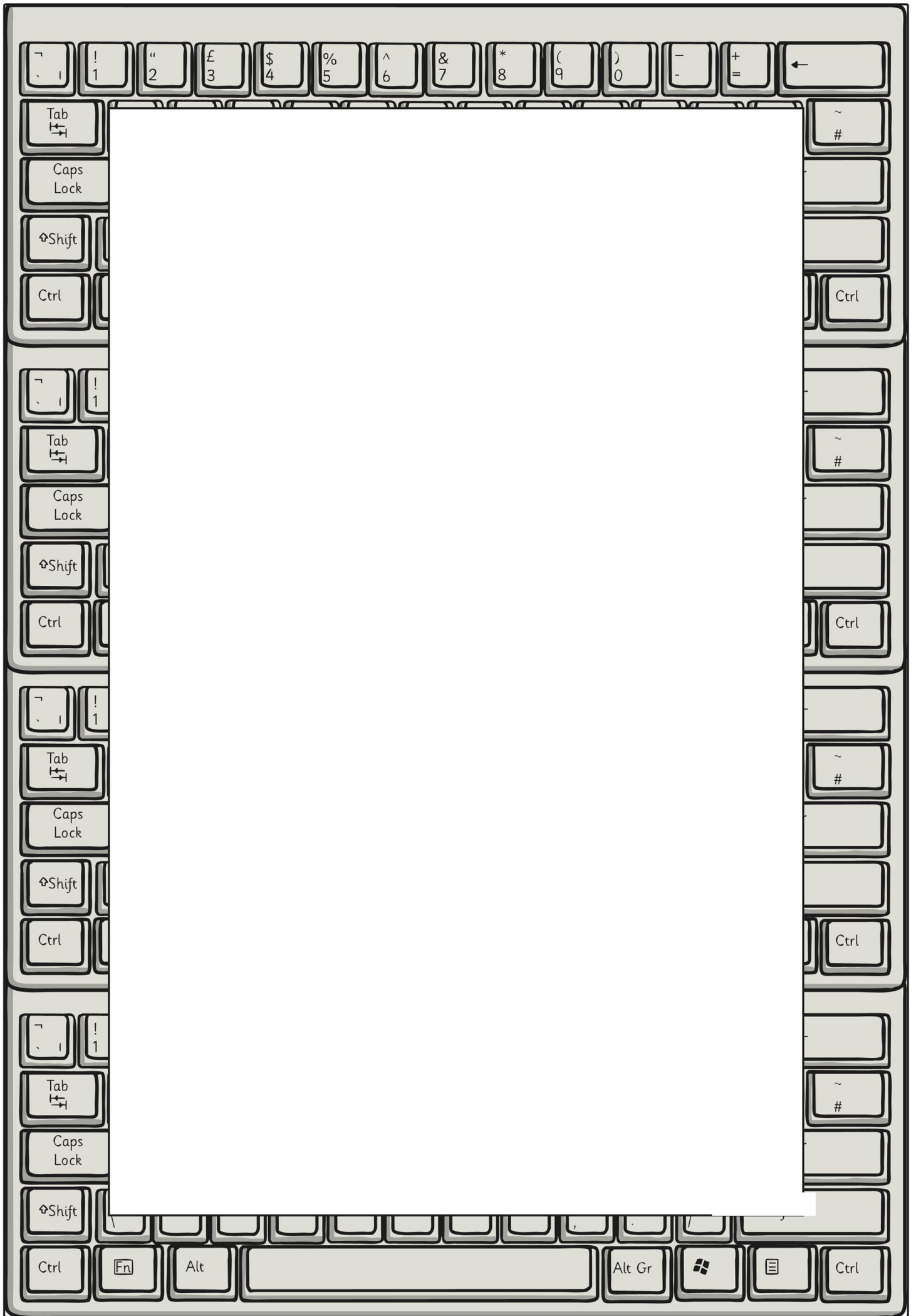

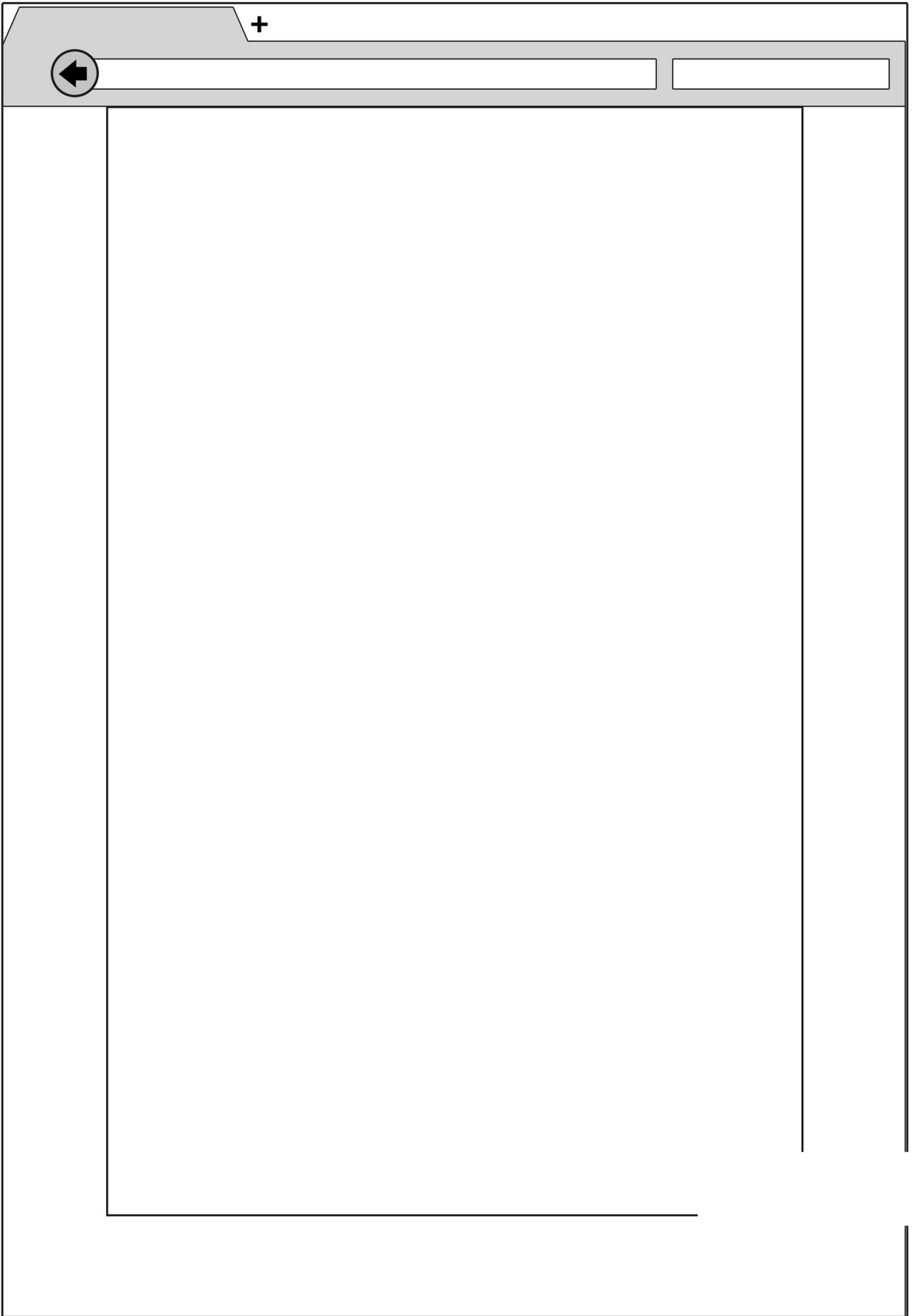

+



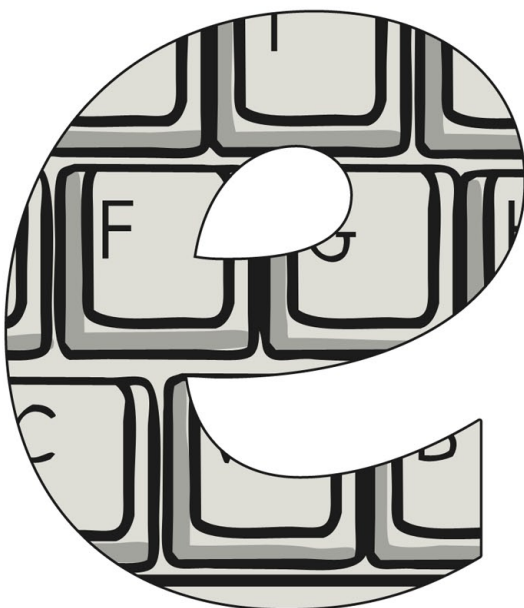
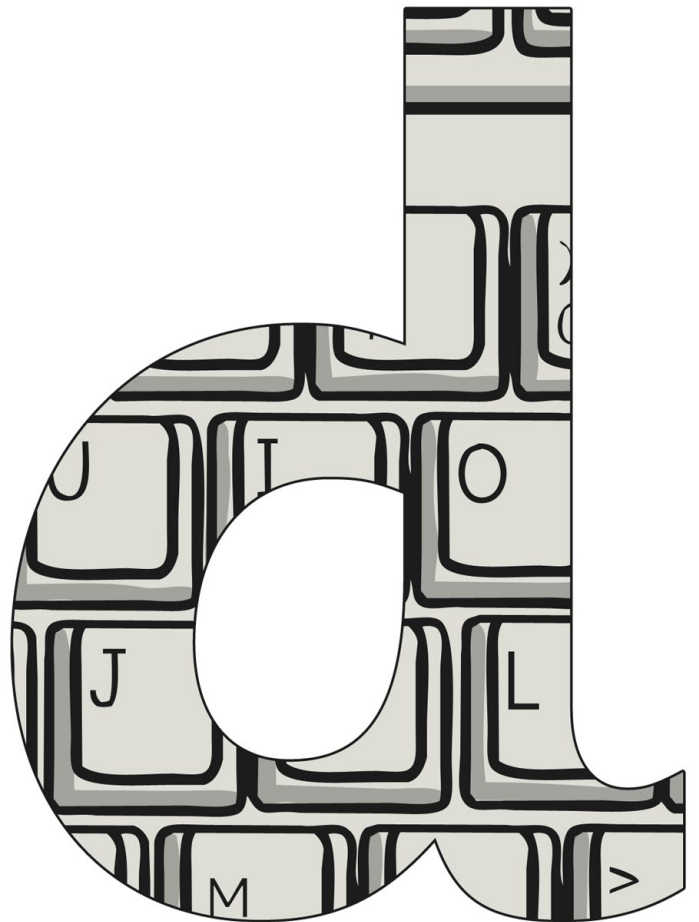
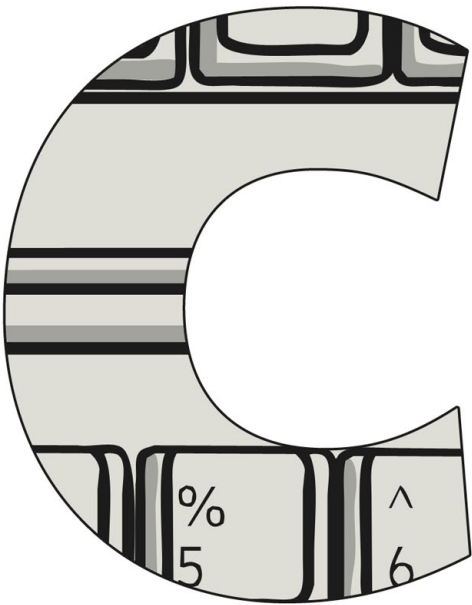
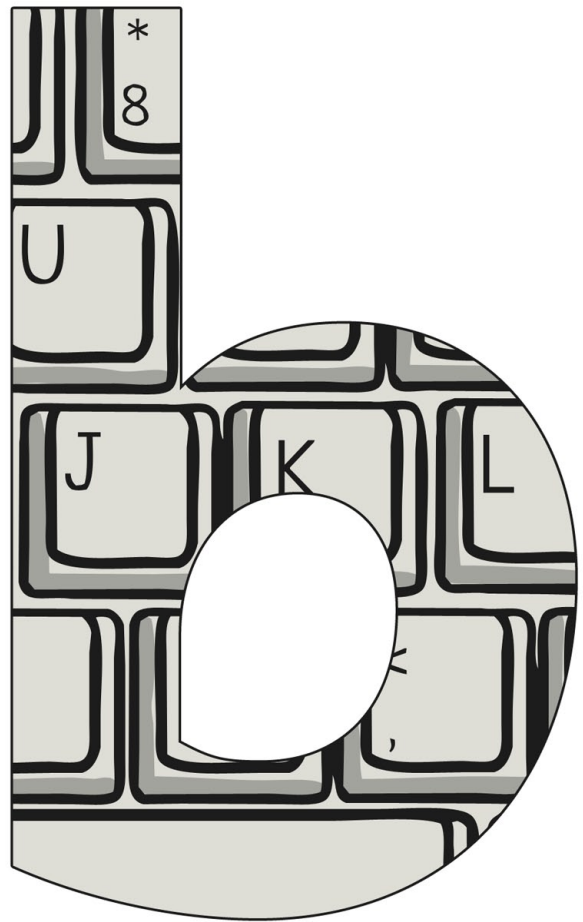

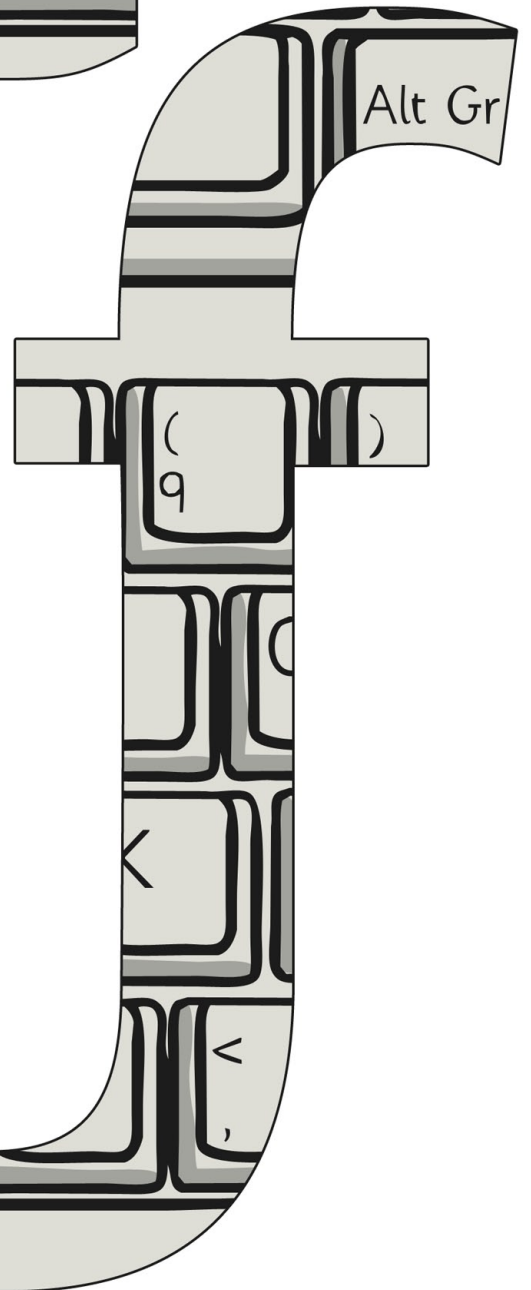
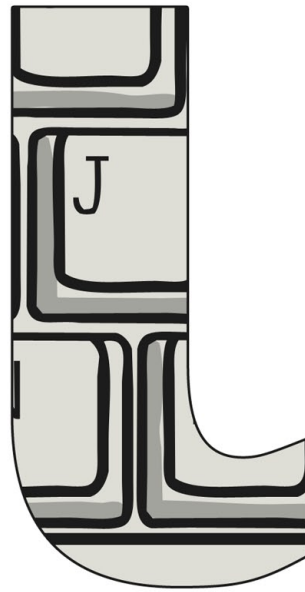
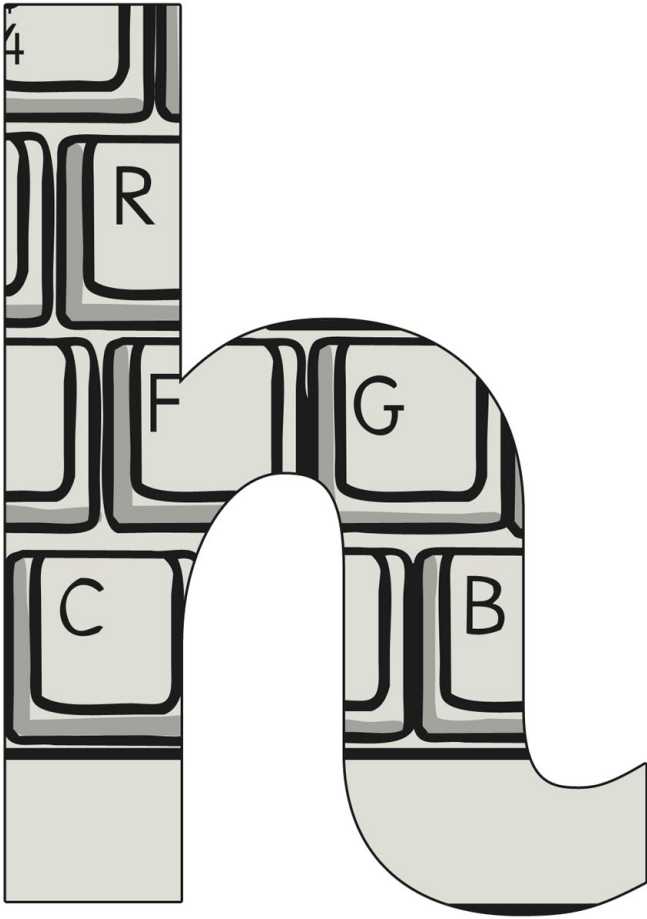

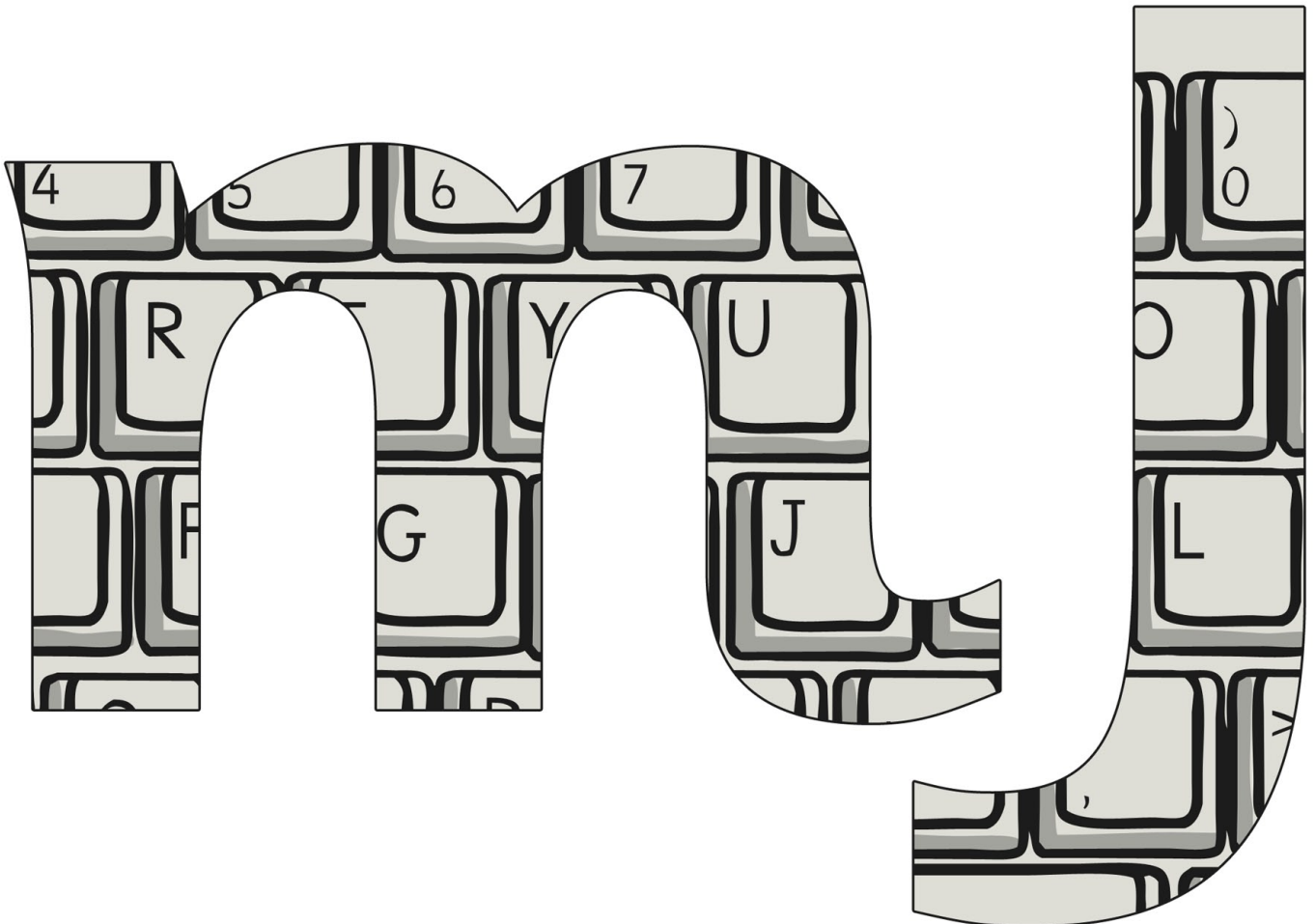
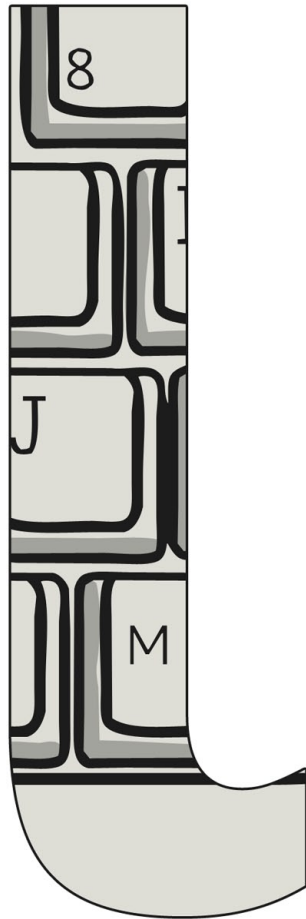



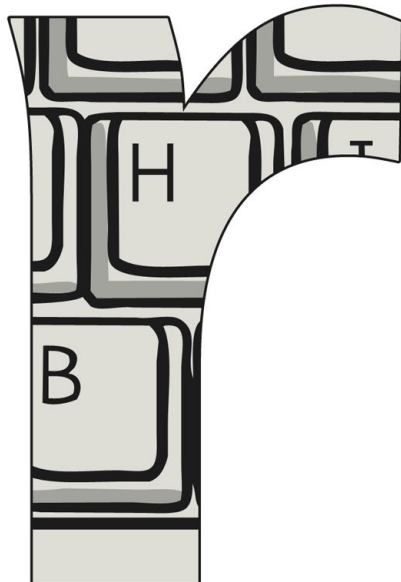
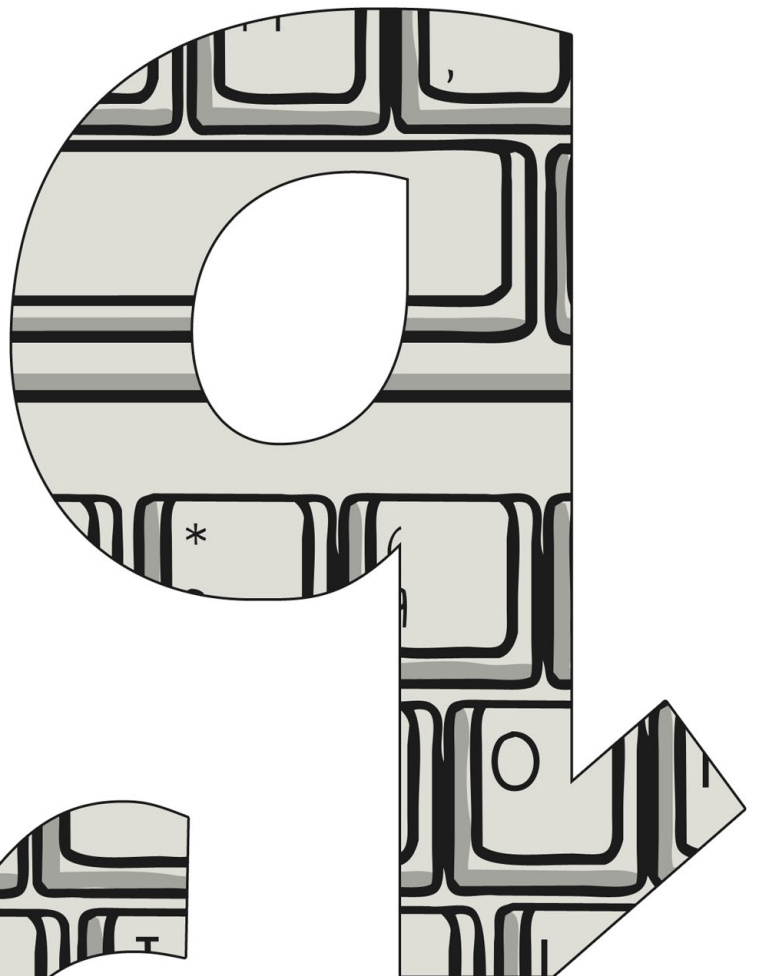
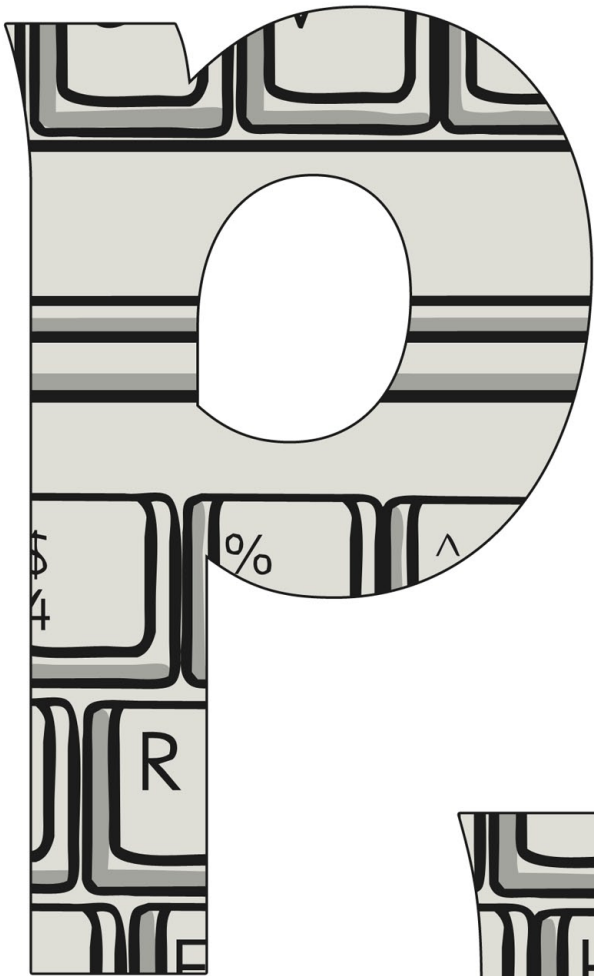
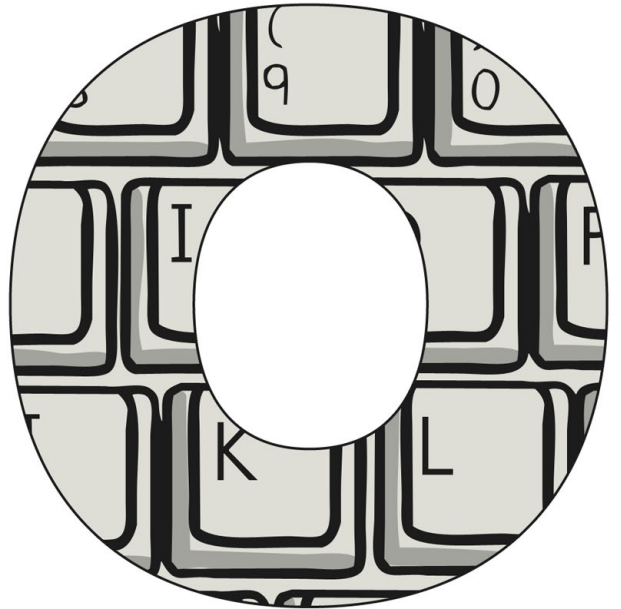

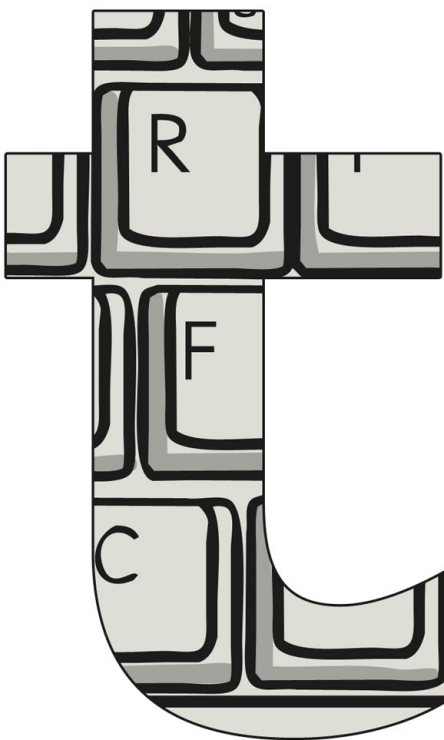
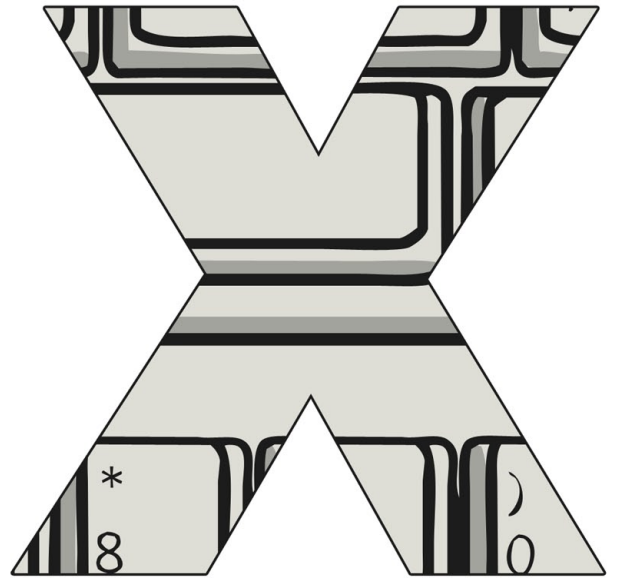
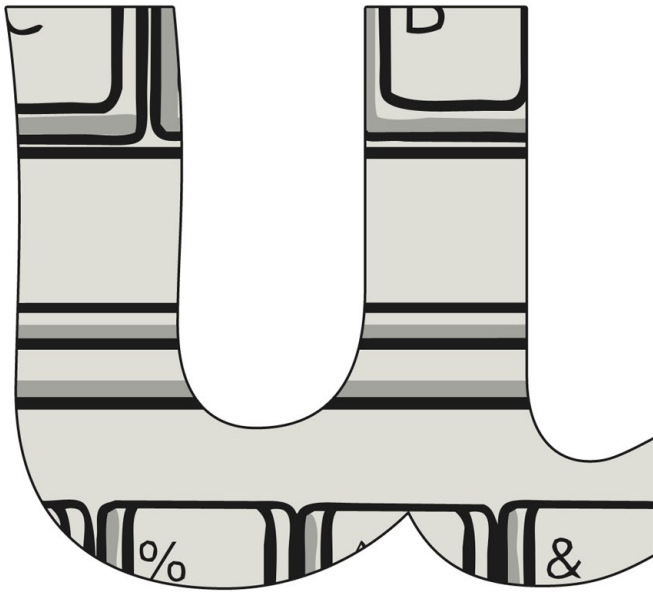
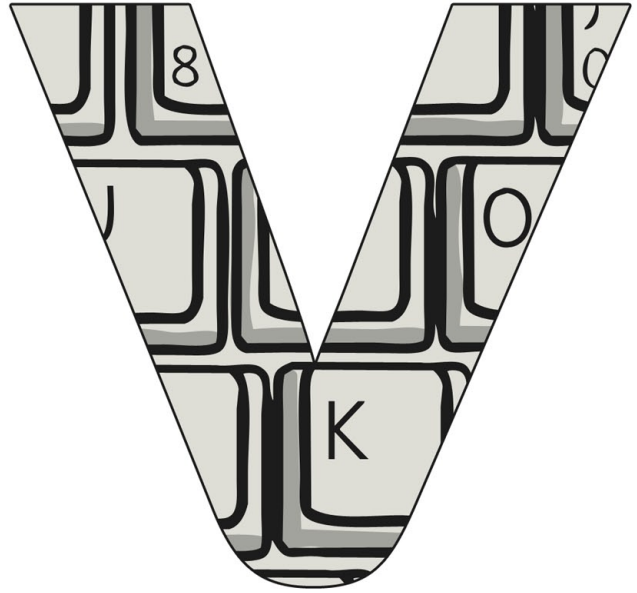

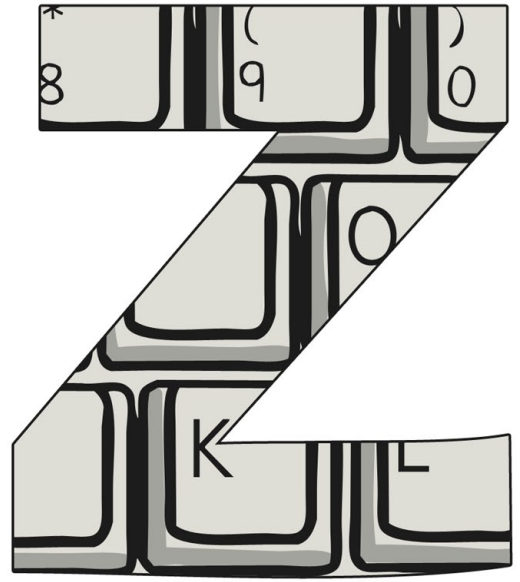

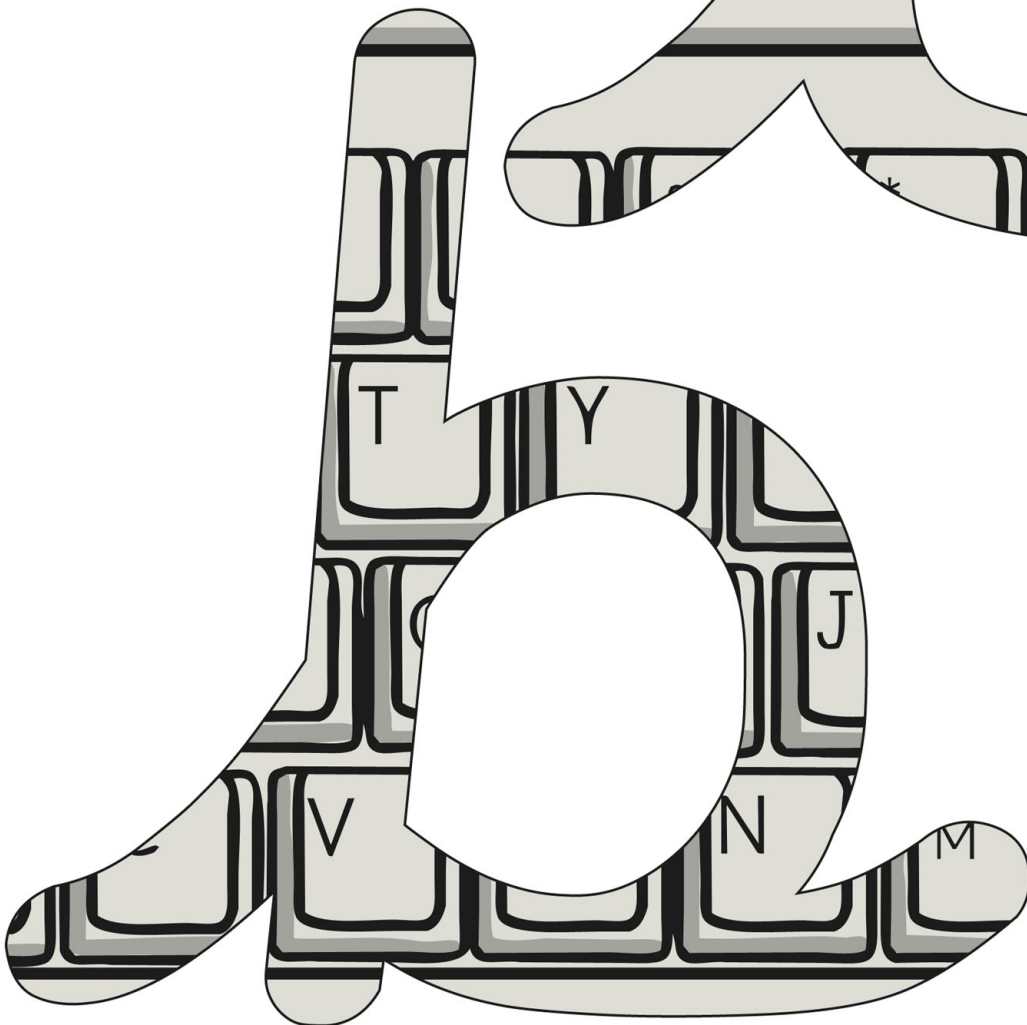
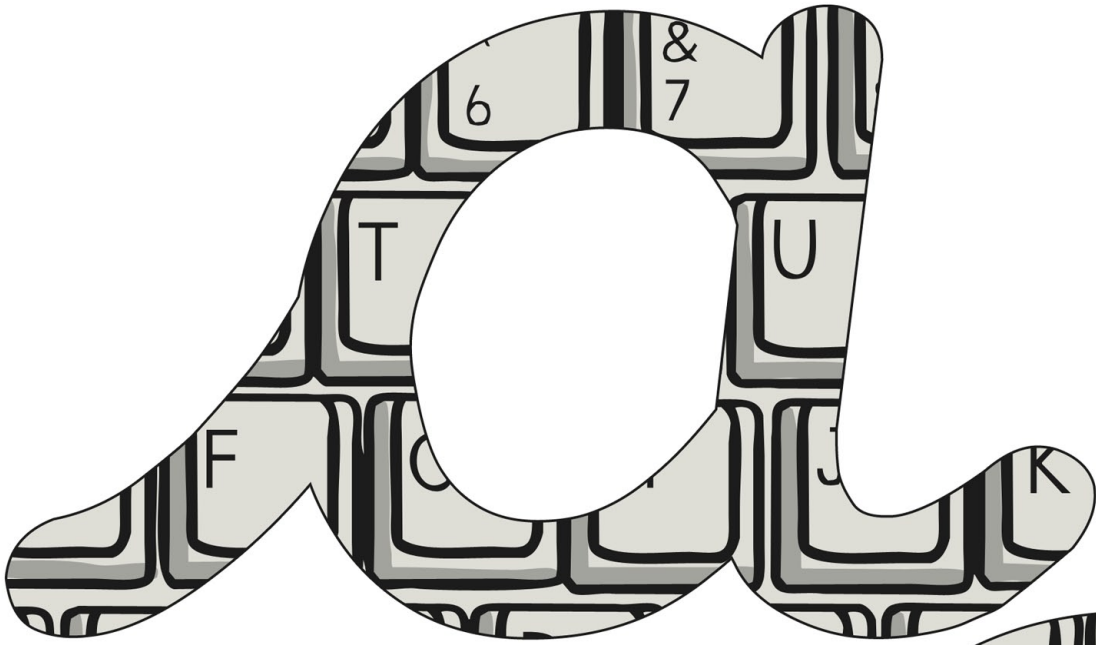

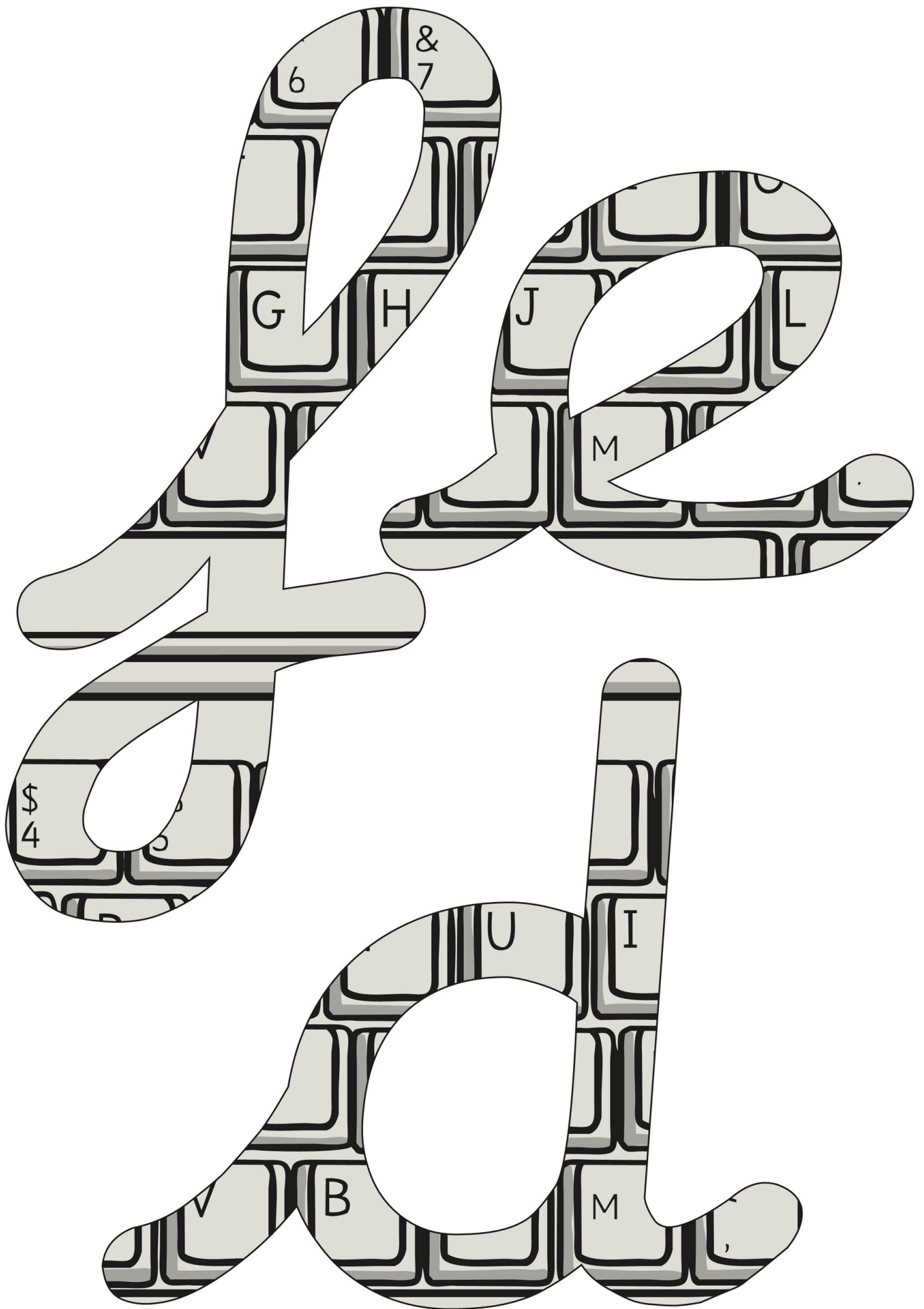

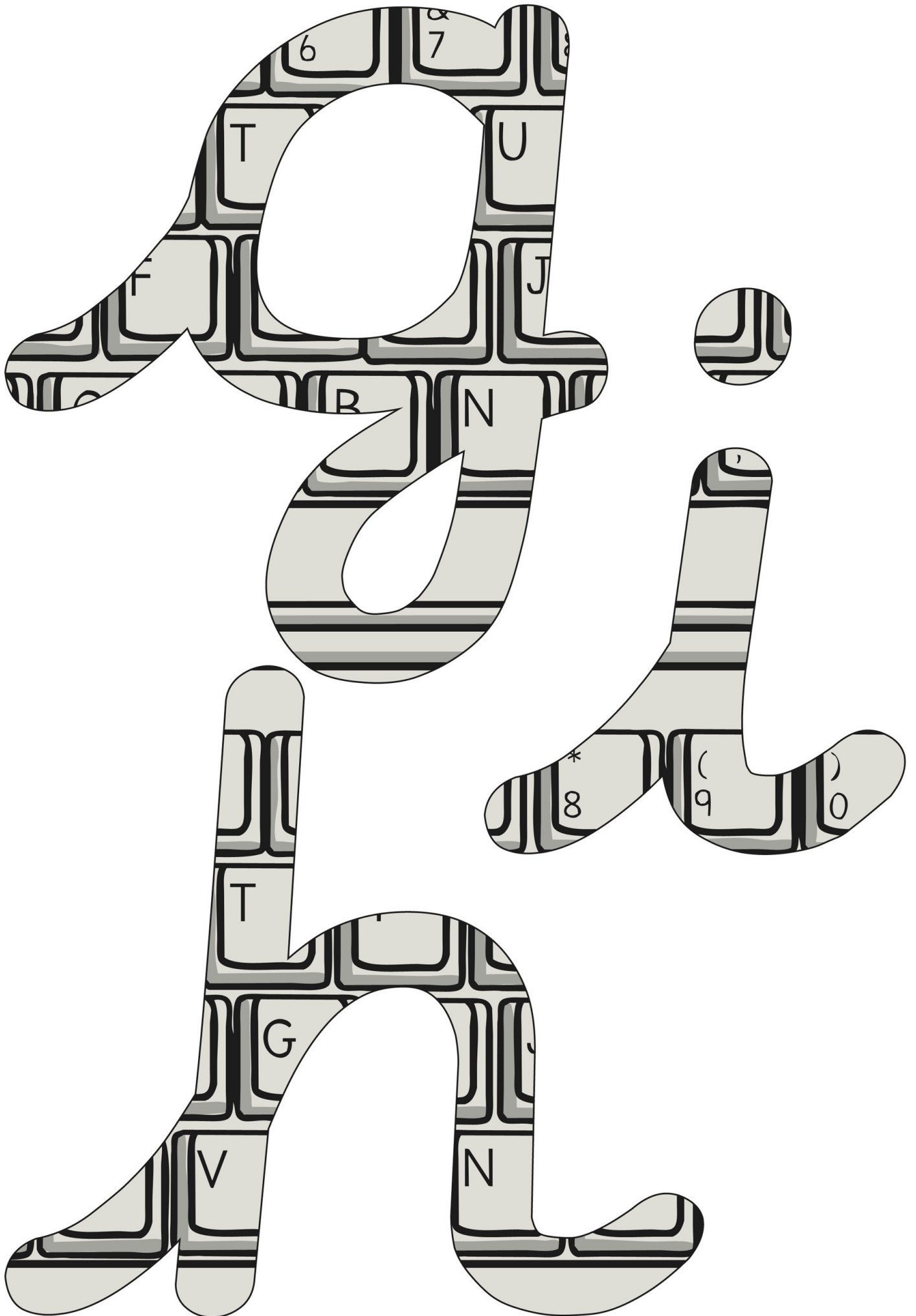

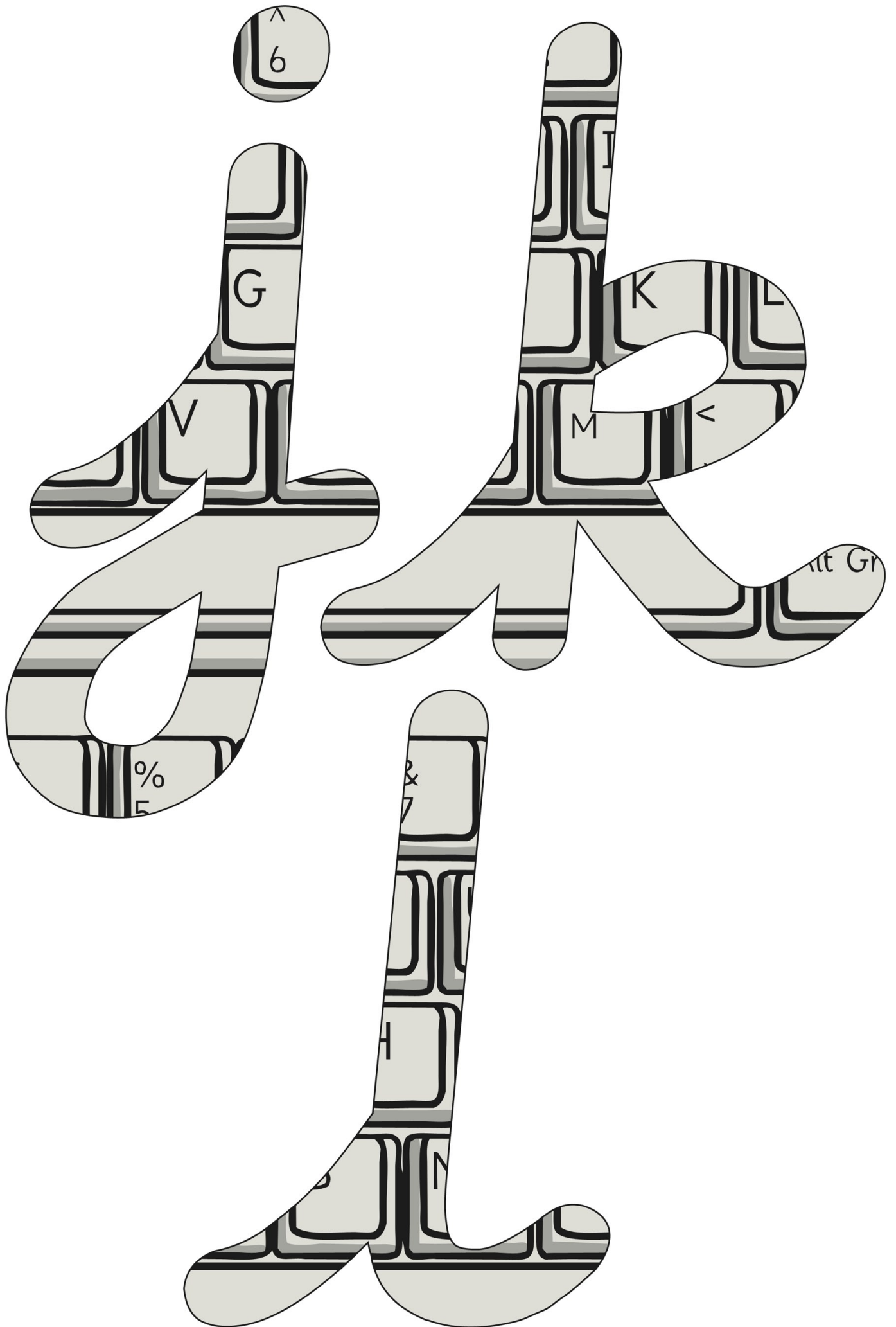

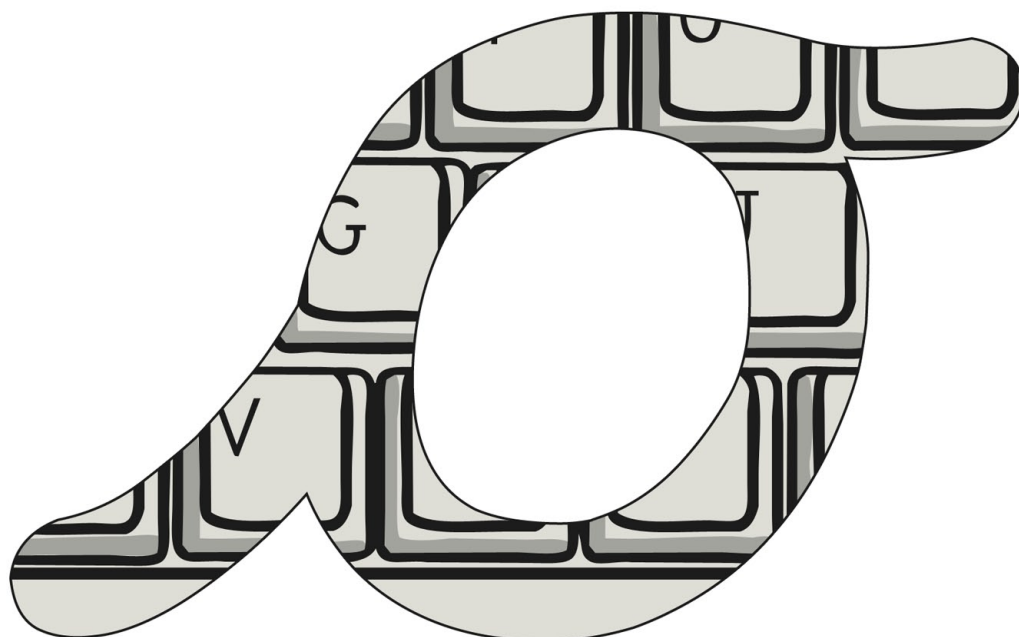
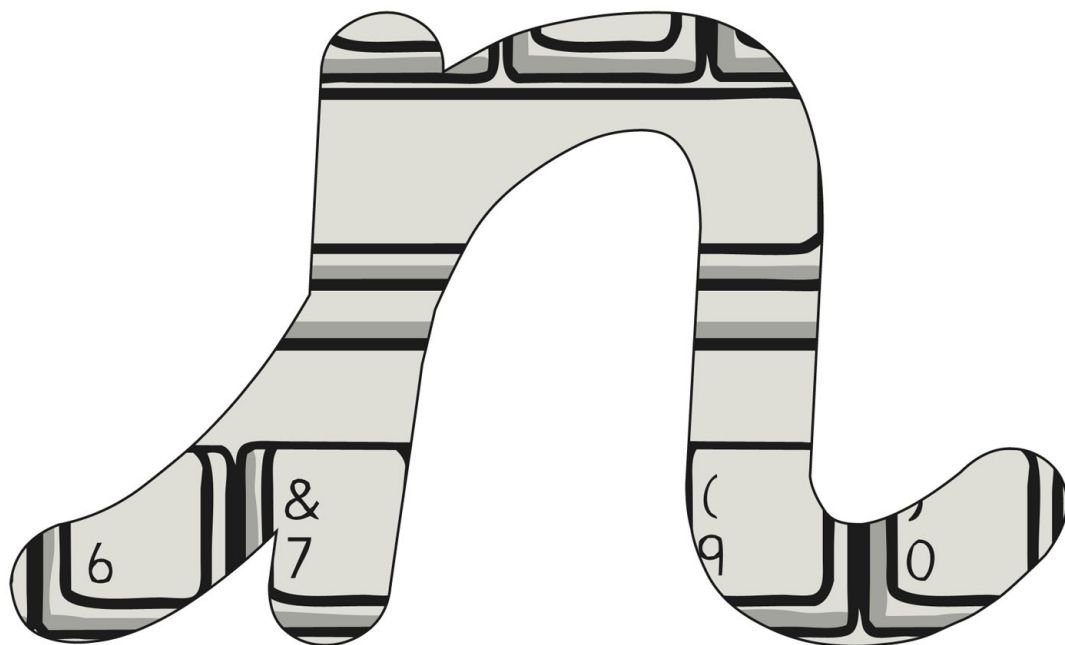
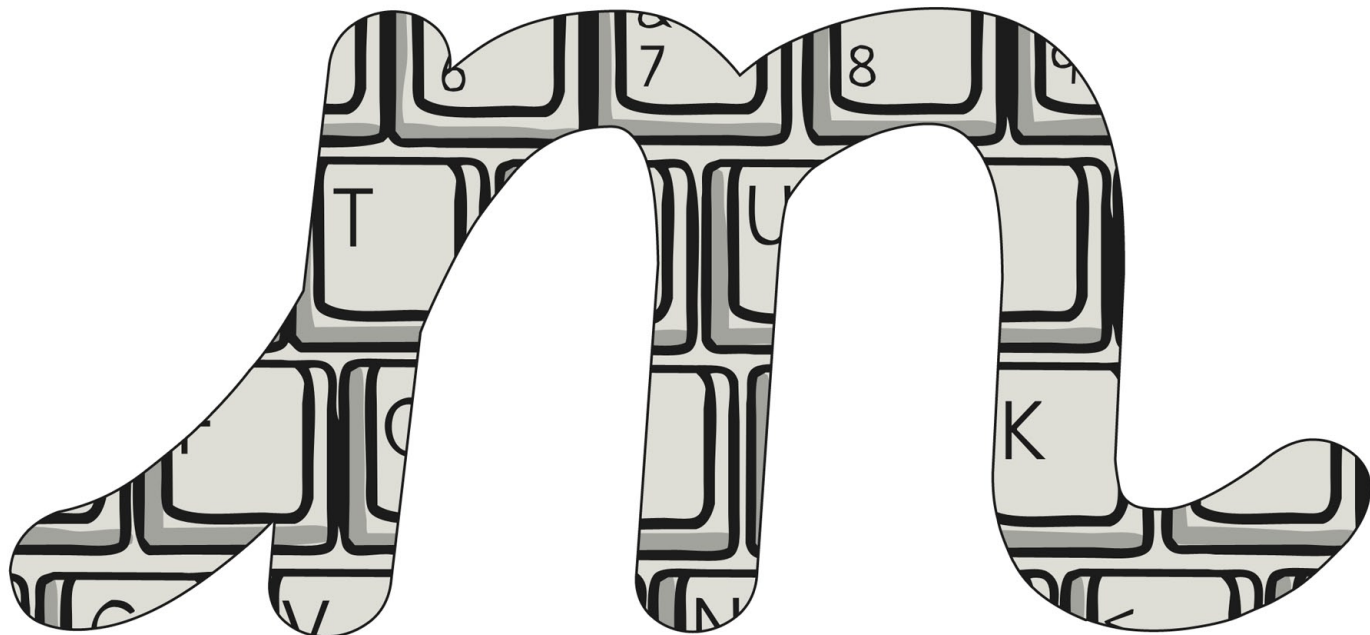



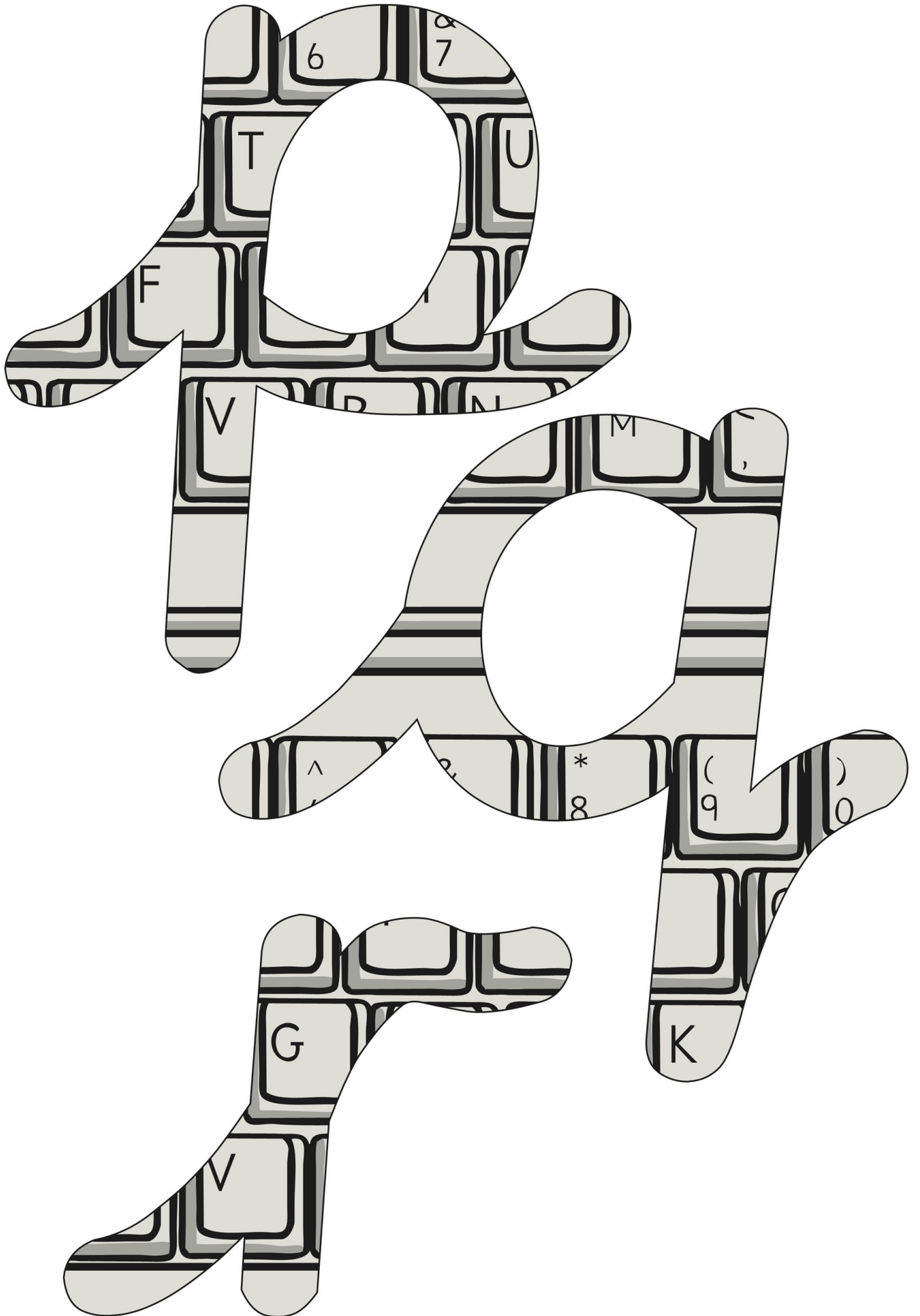

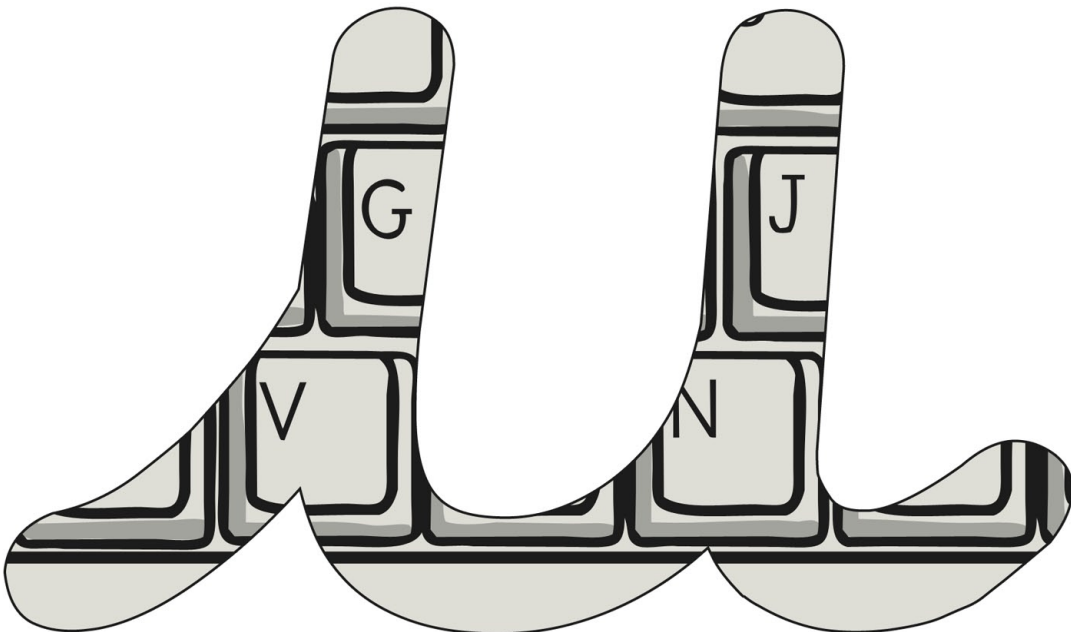
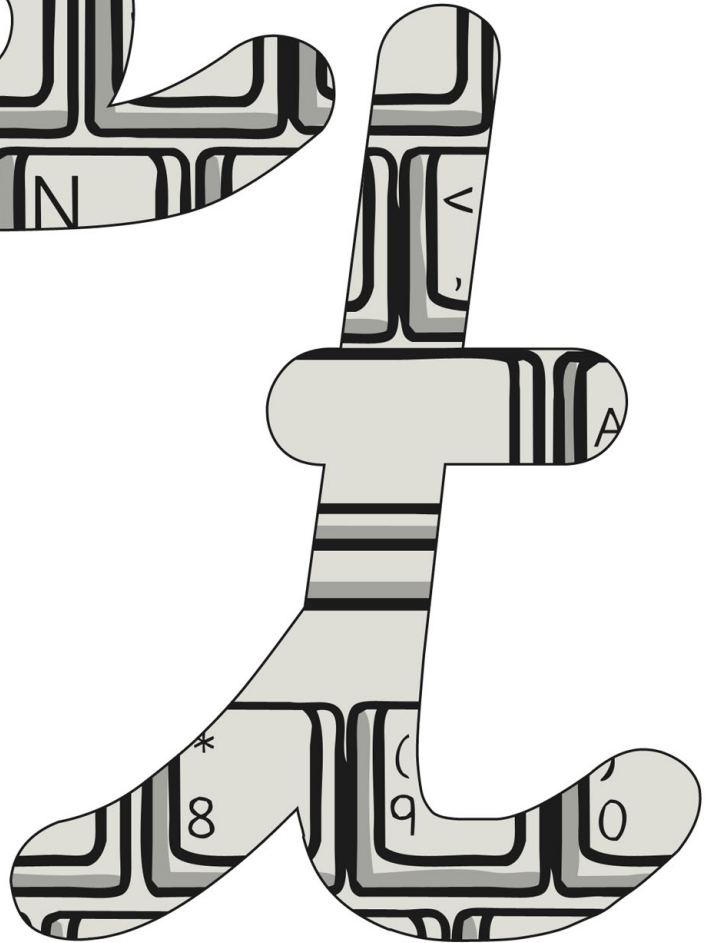
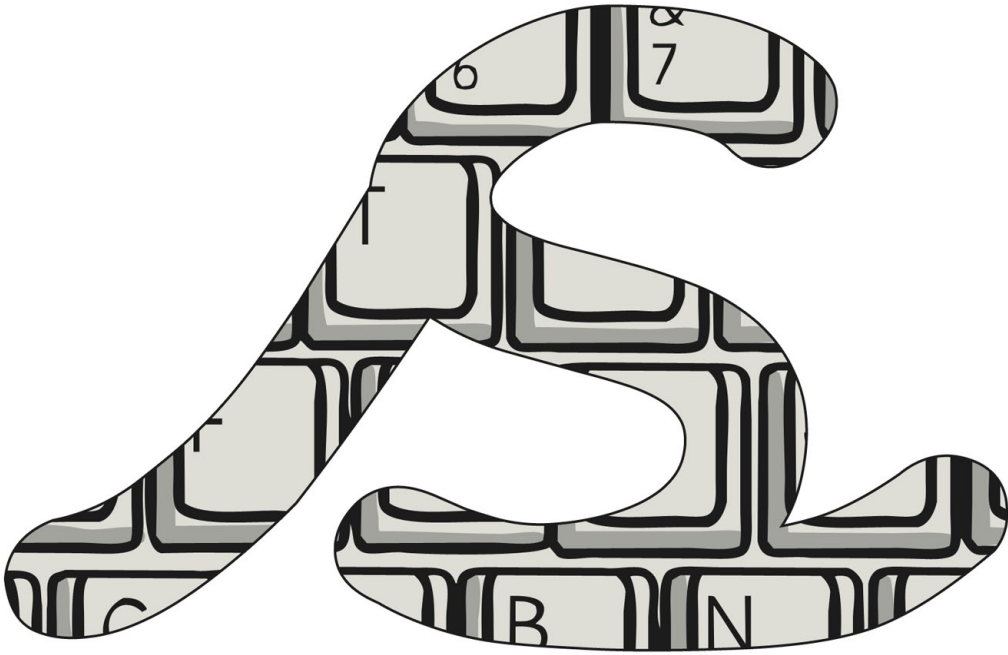

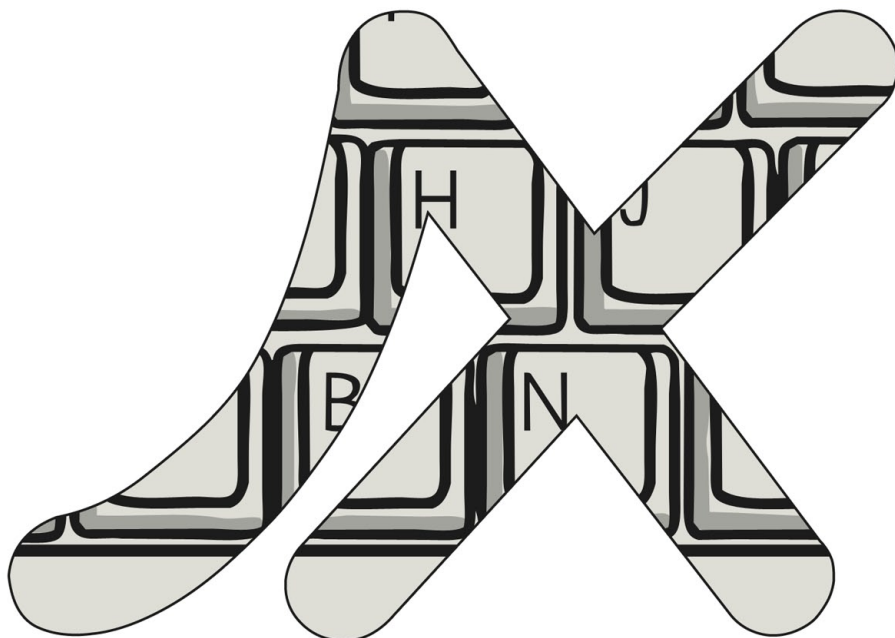
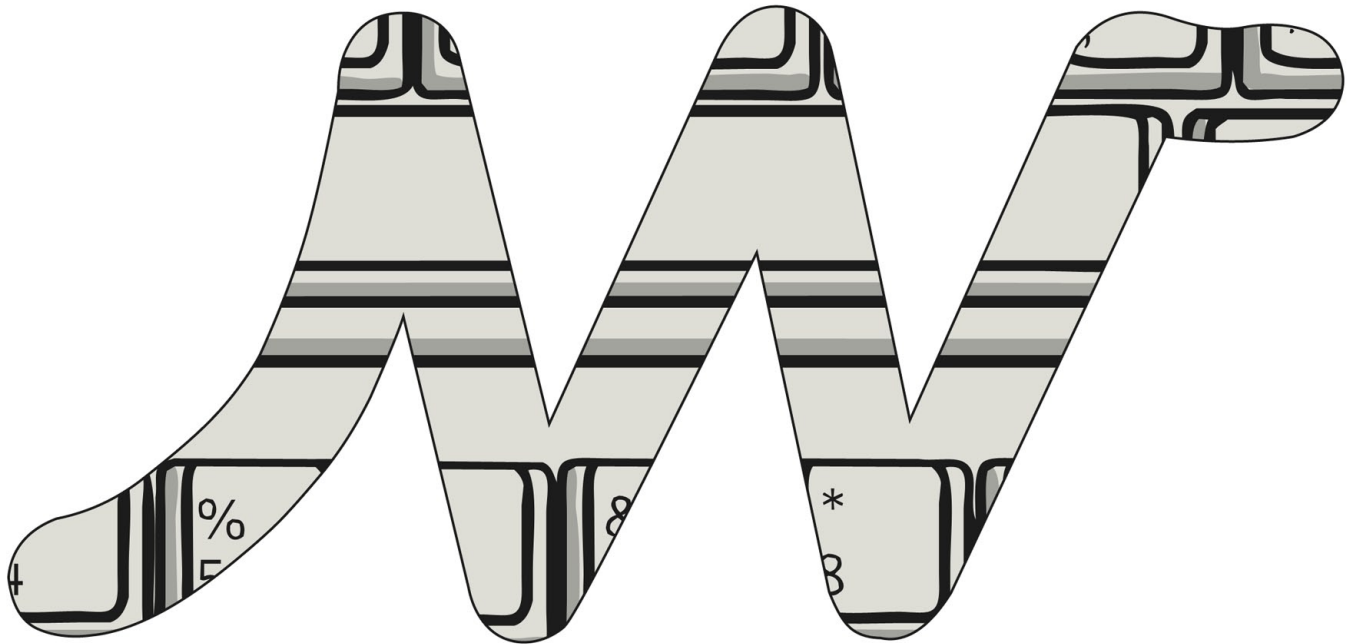
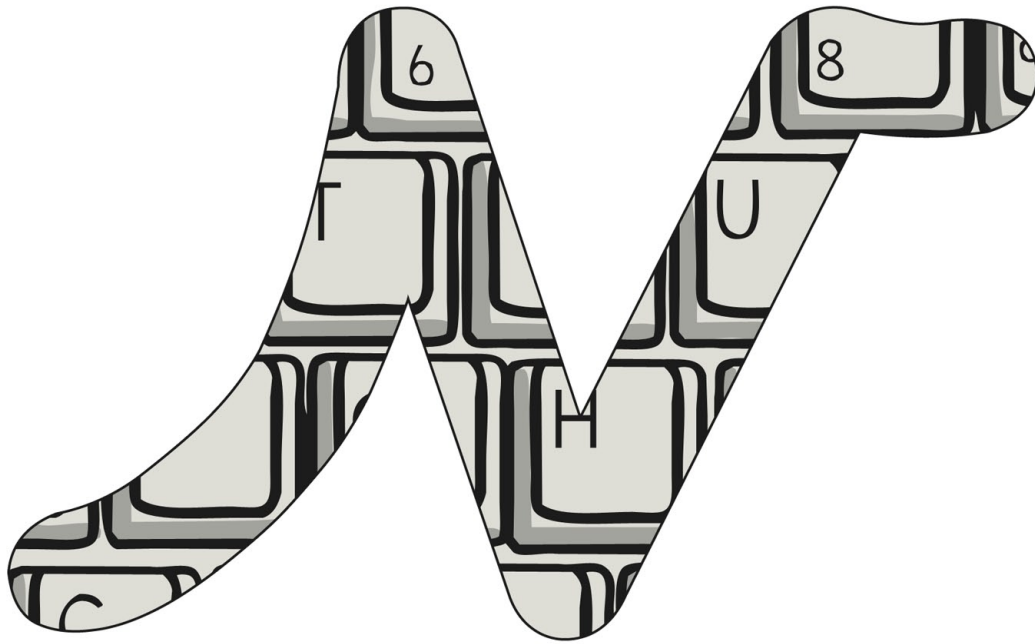

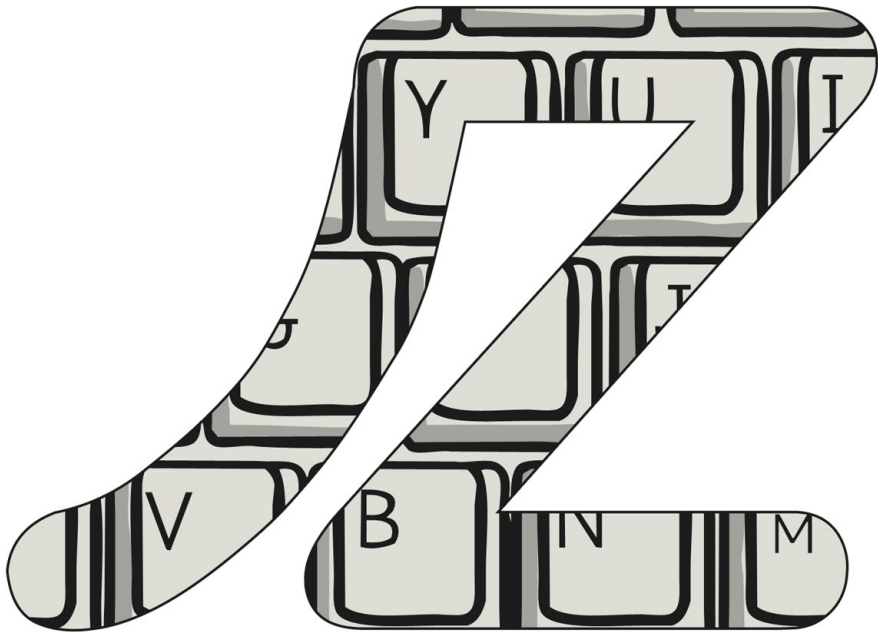
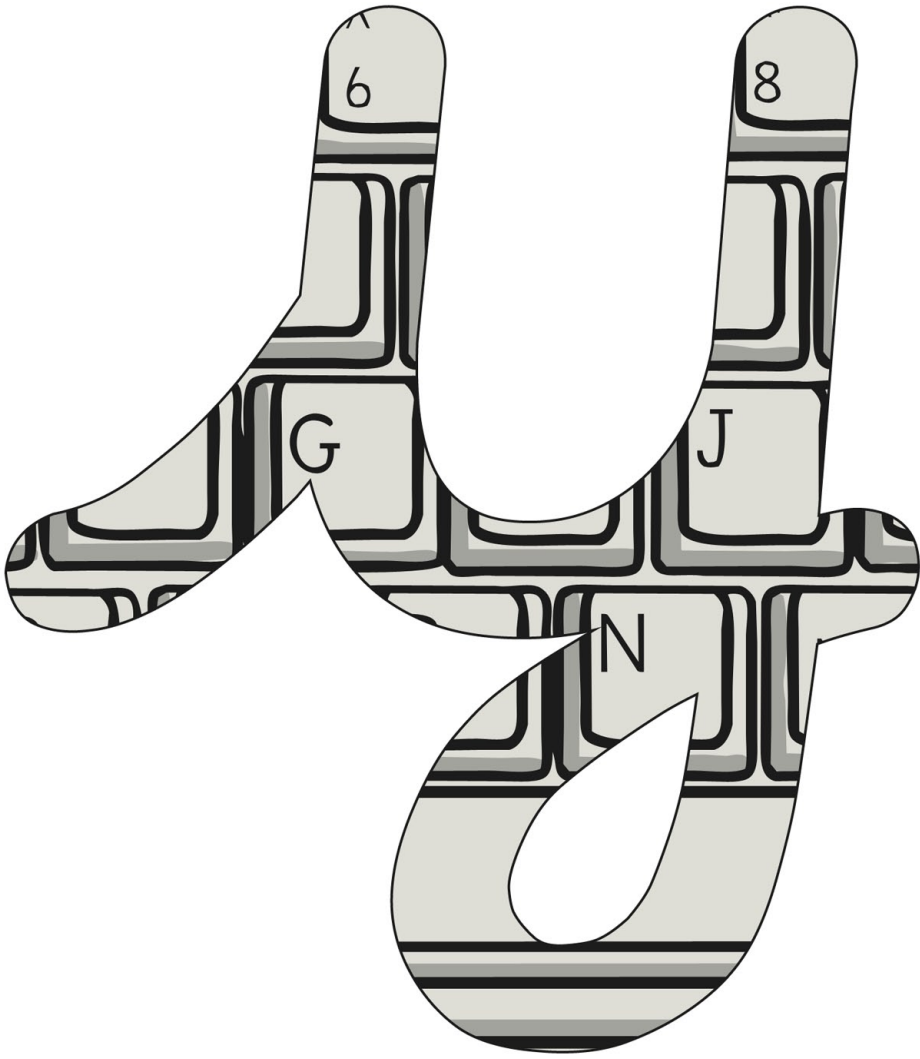

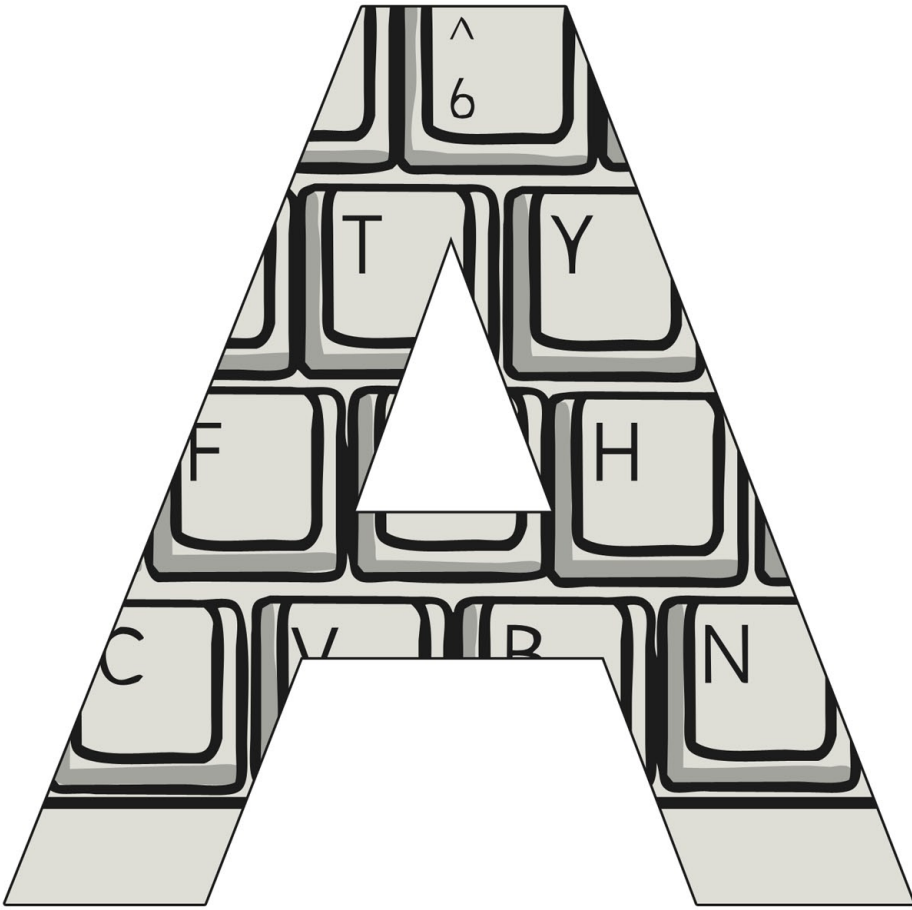

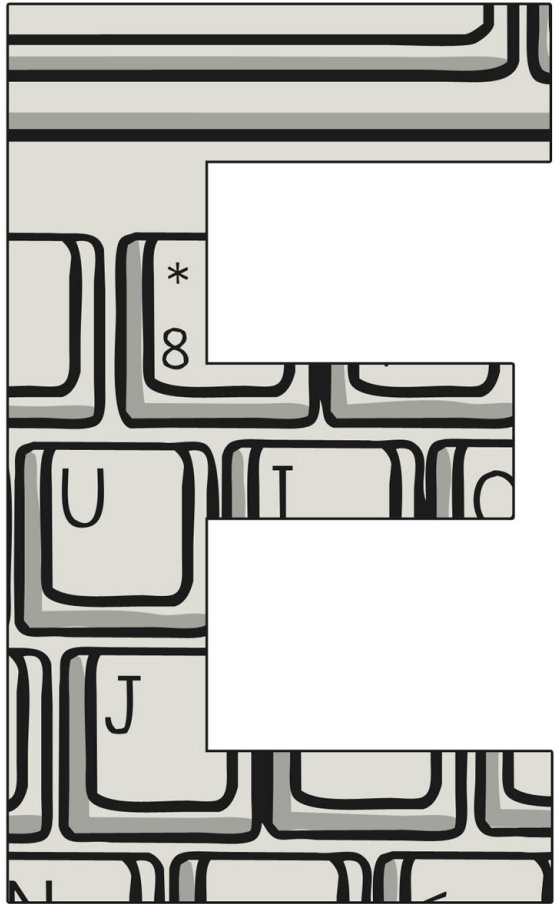
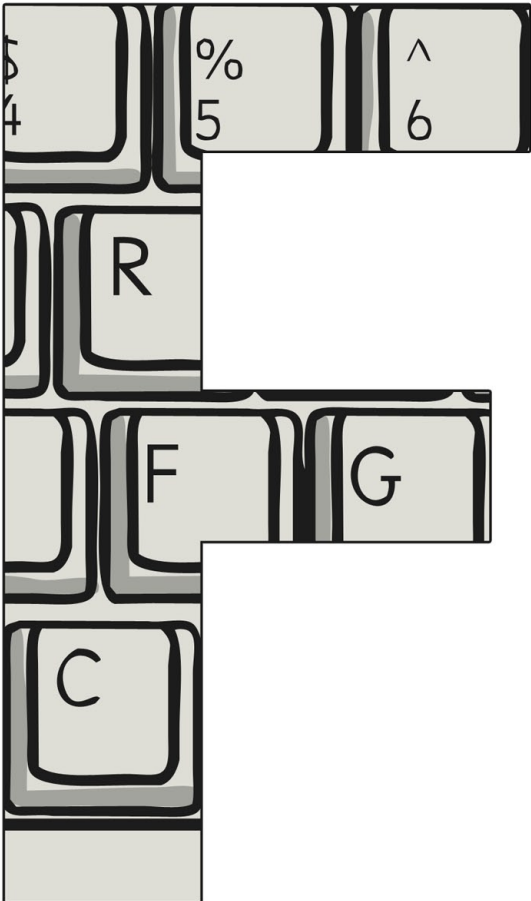

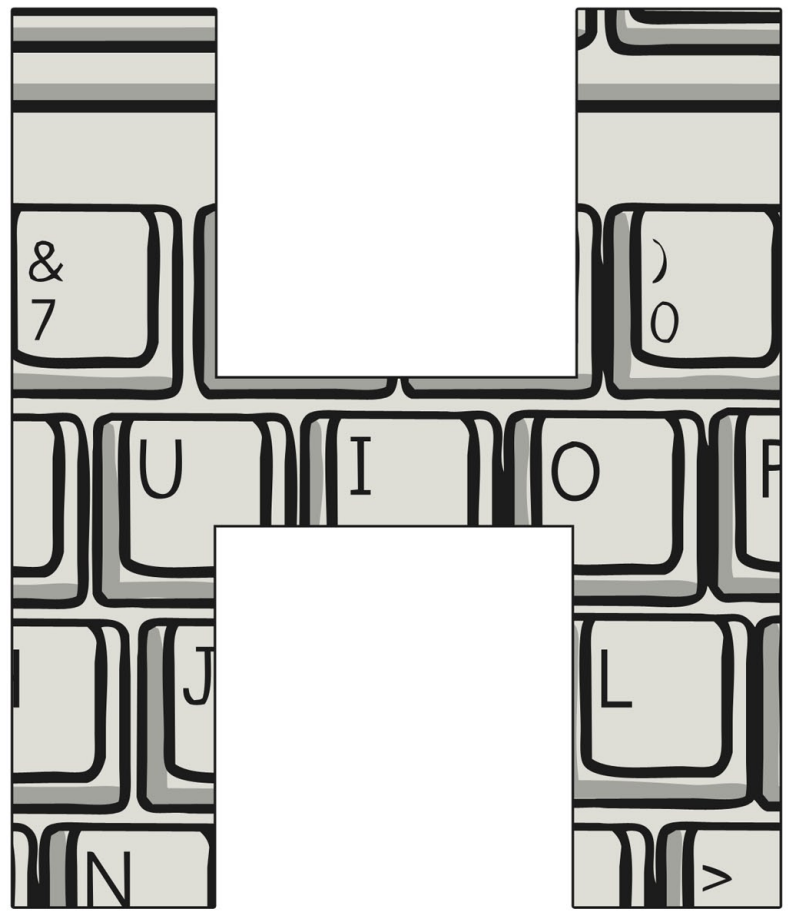
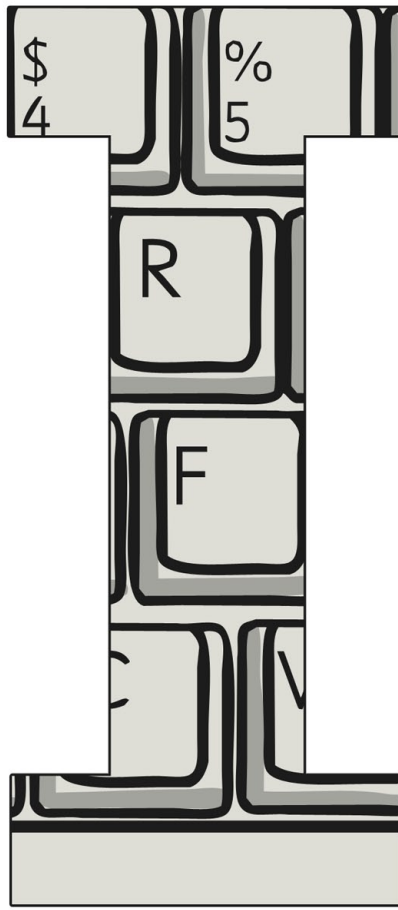
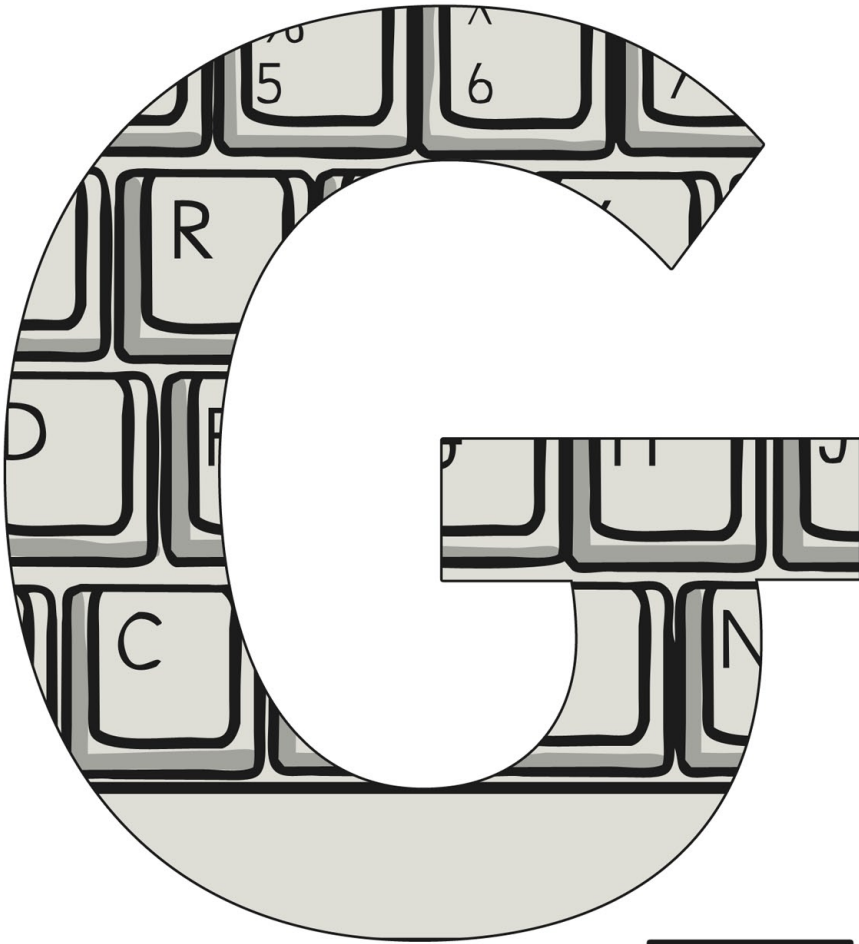

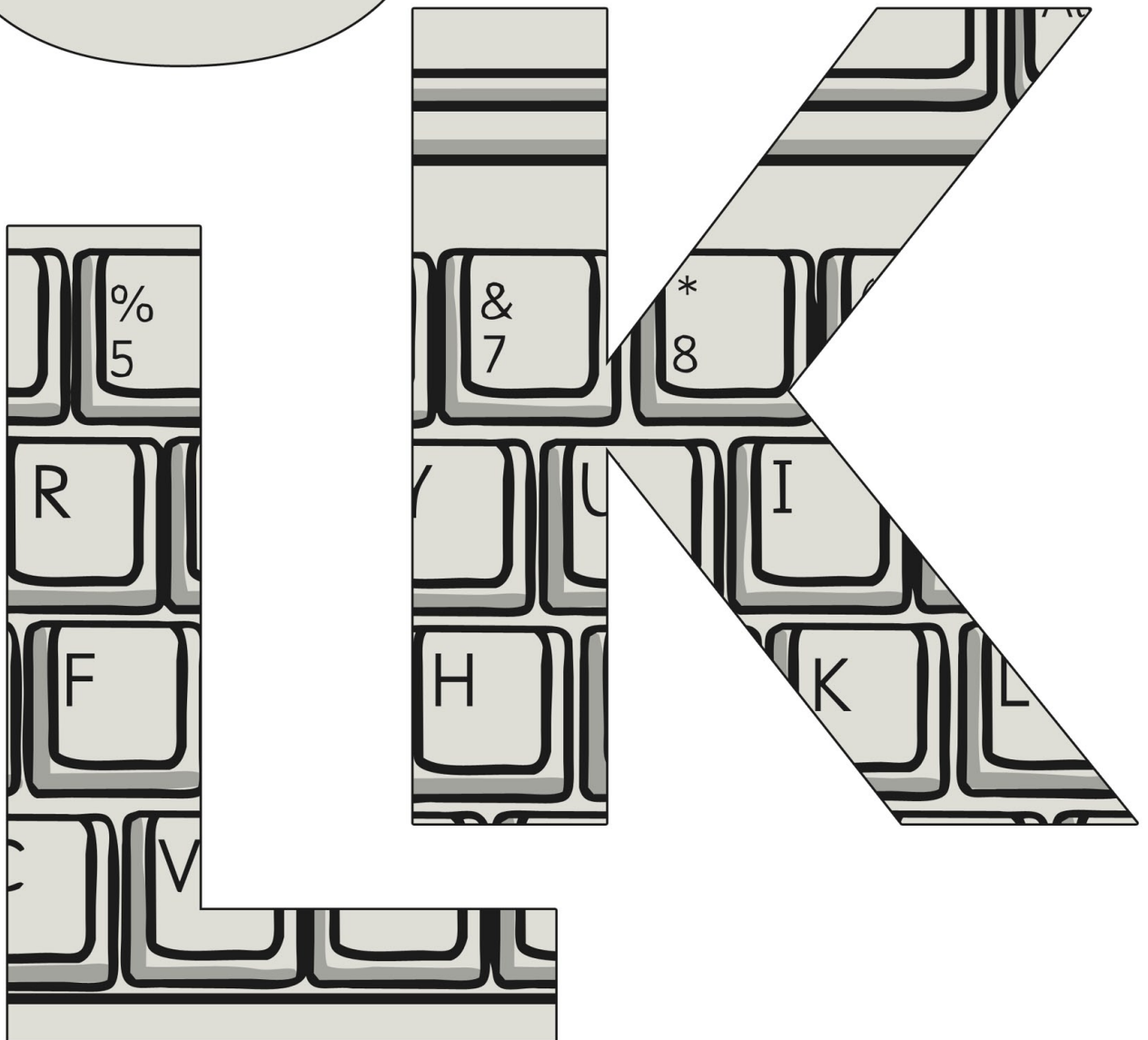
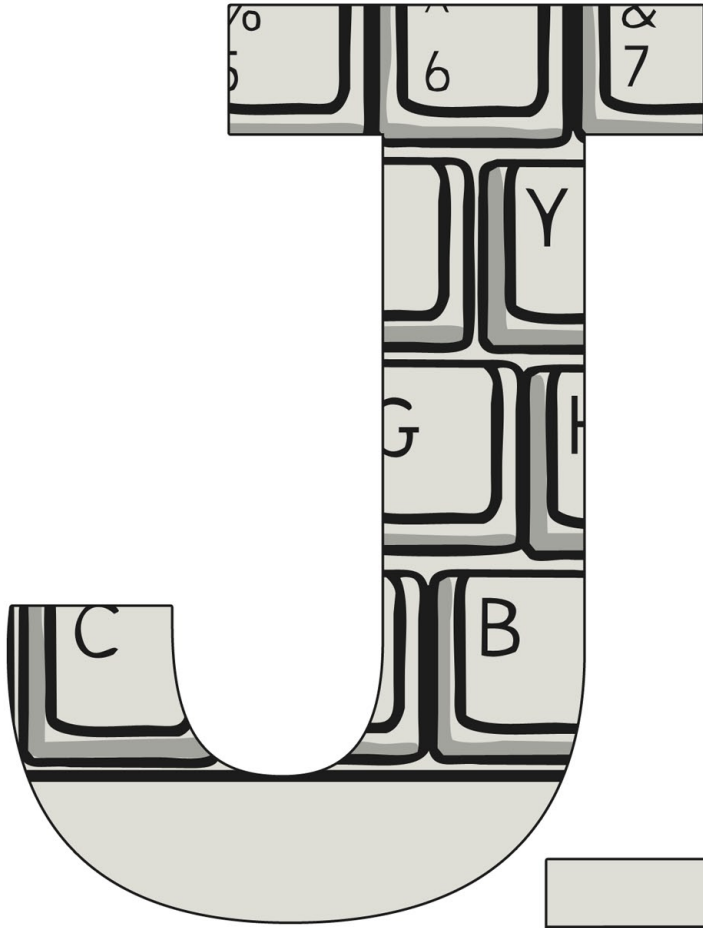



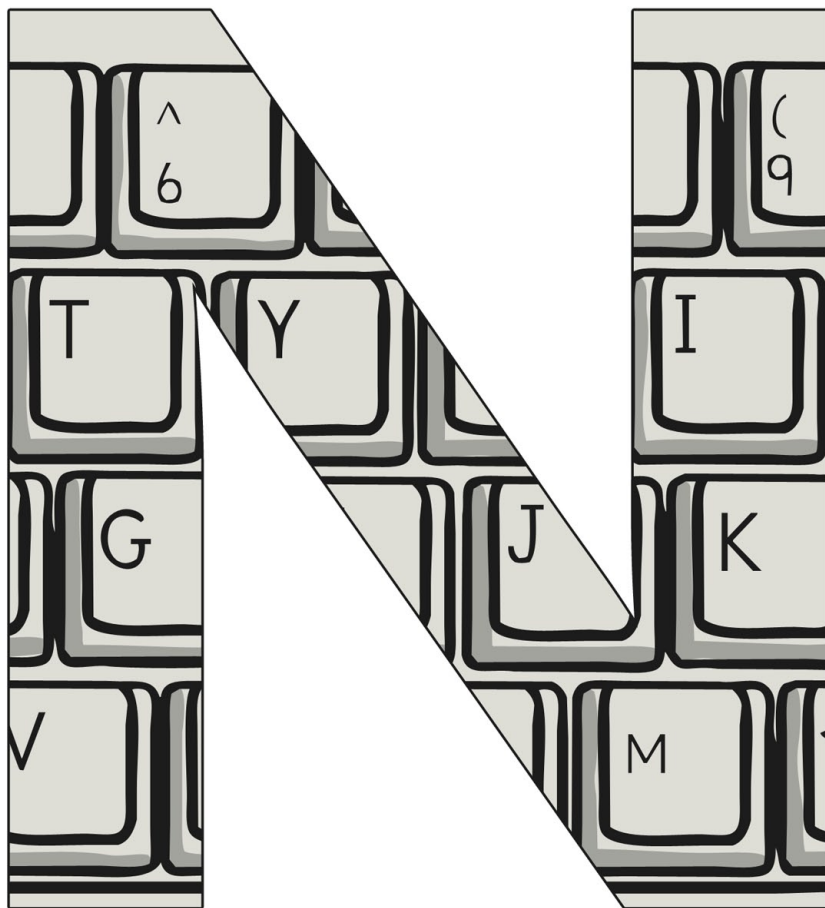
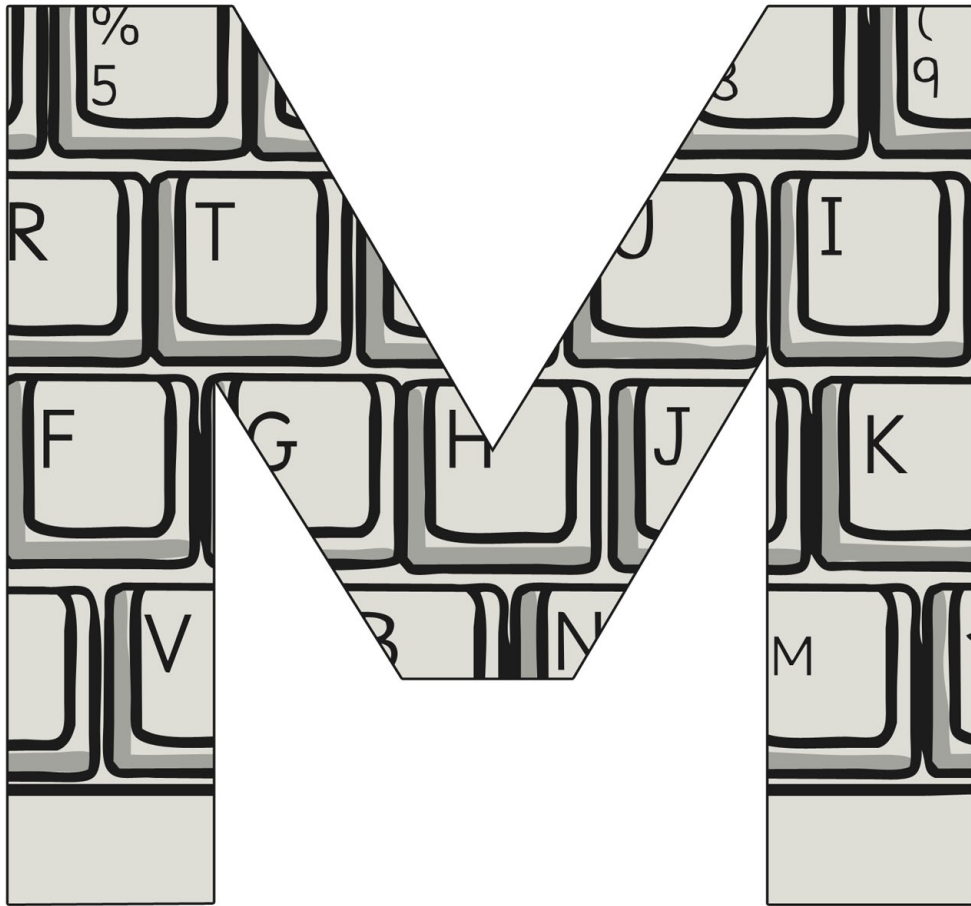







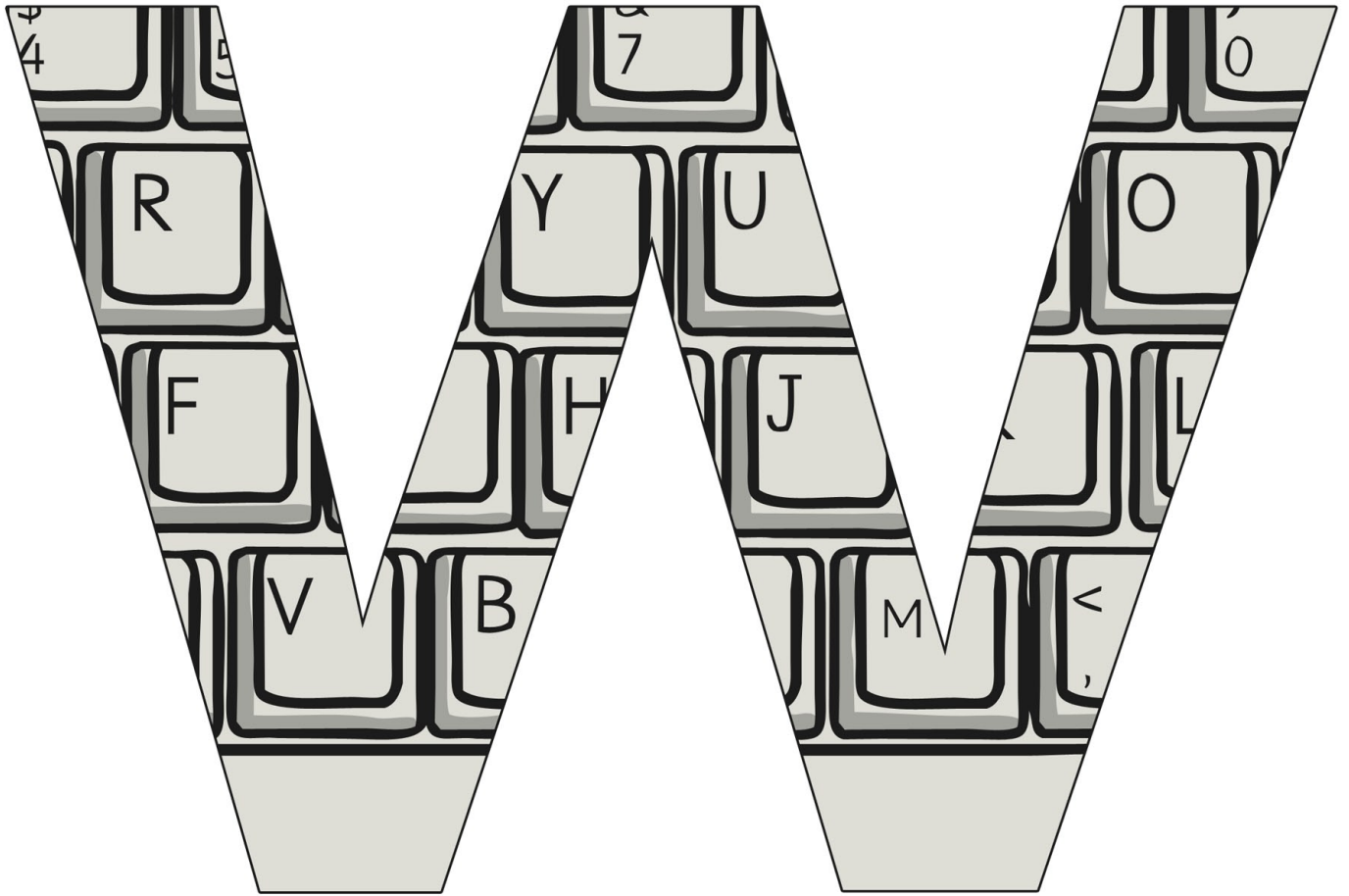

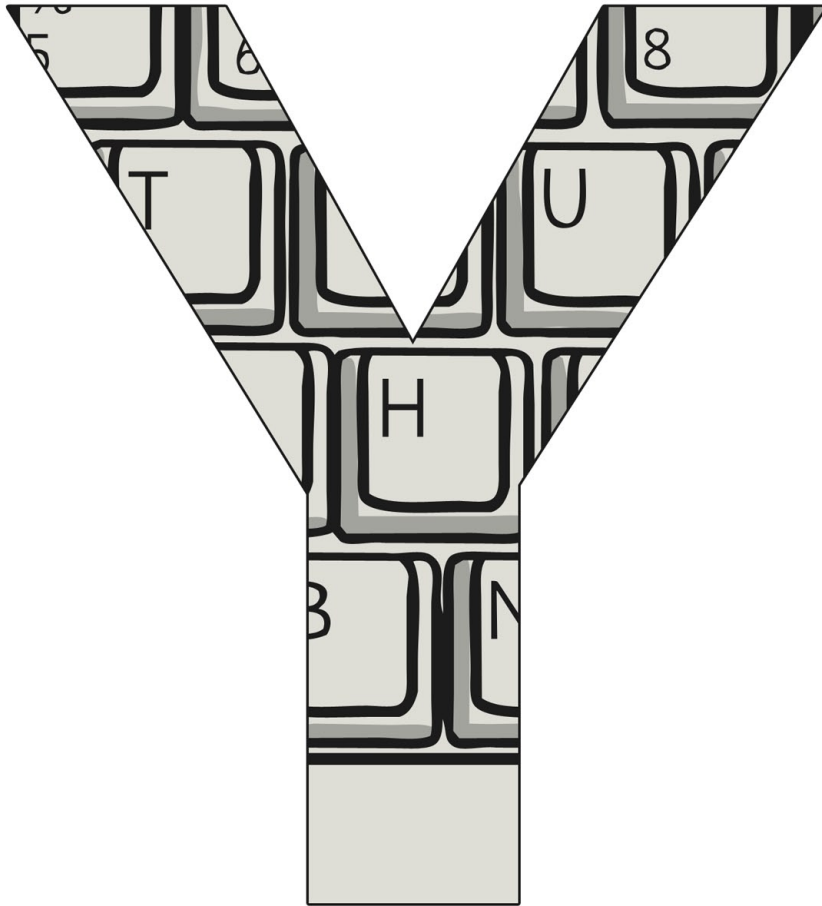

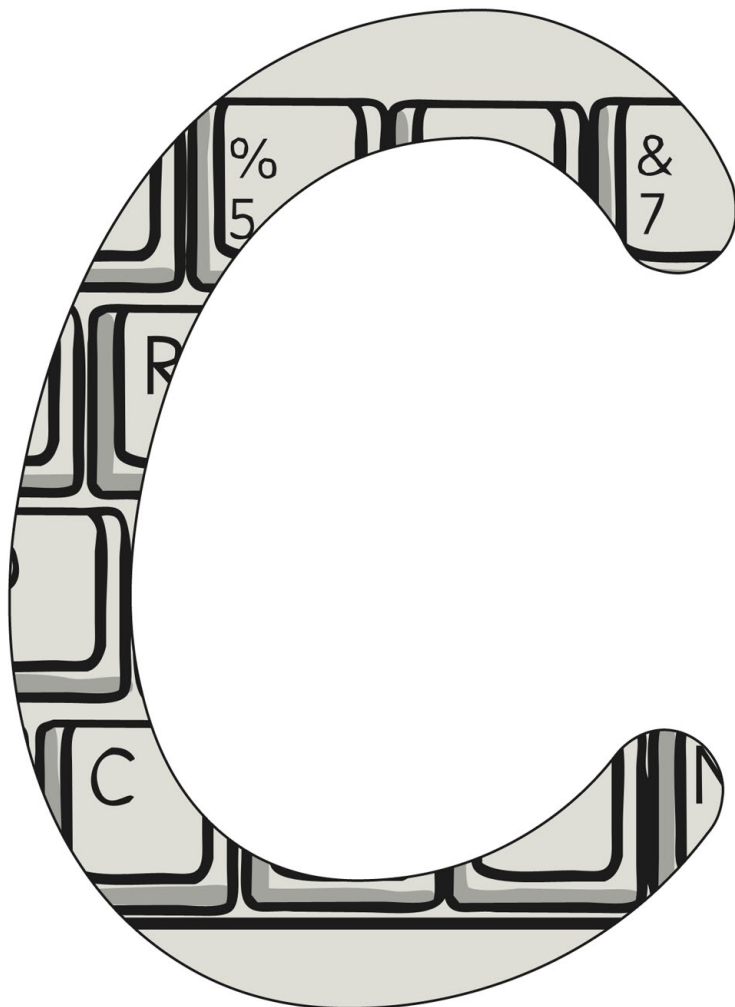
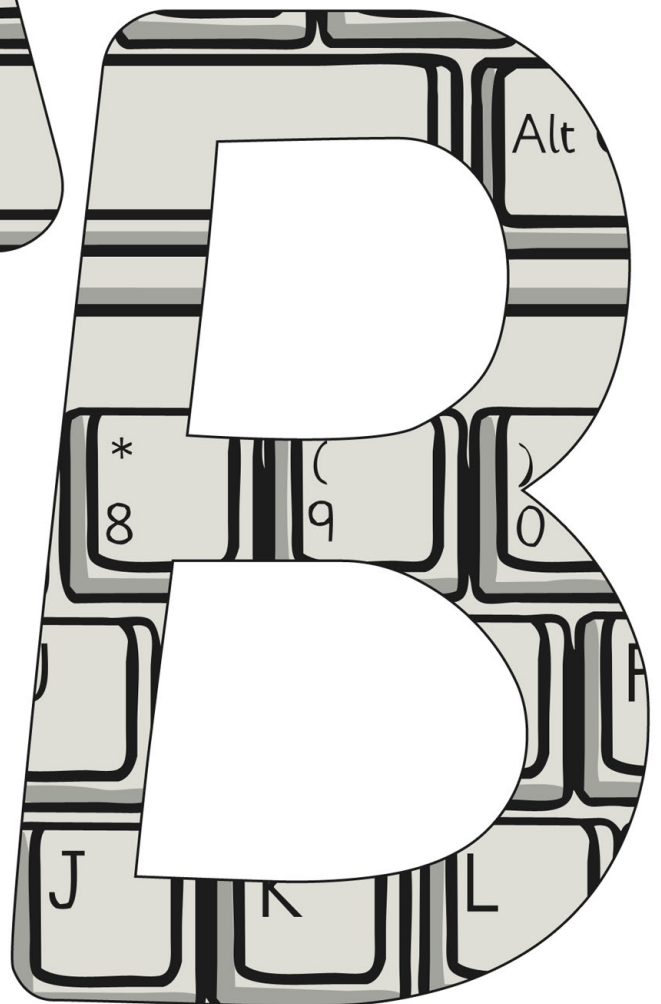
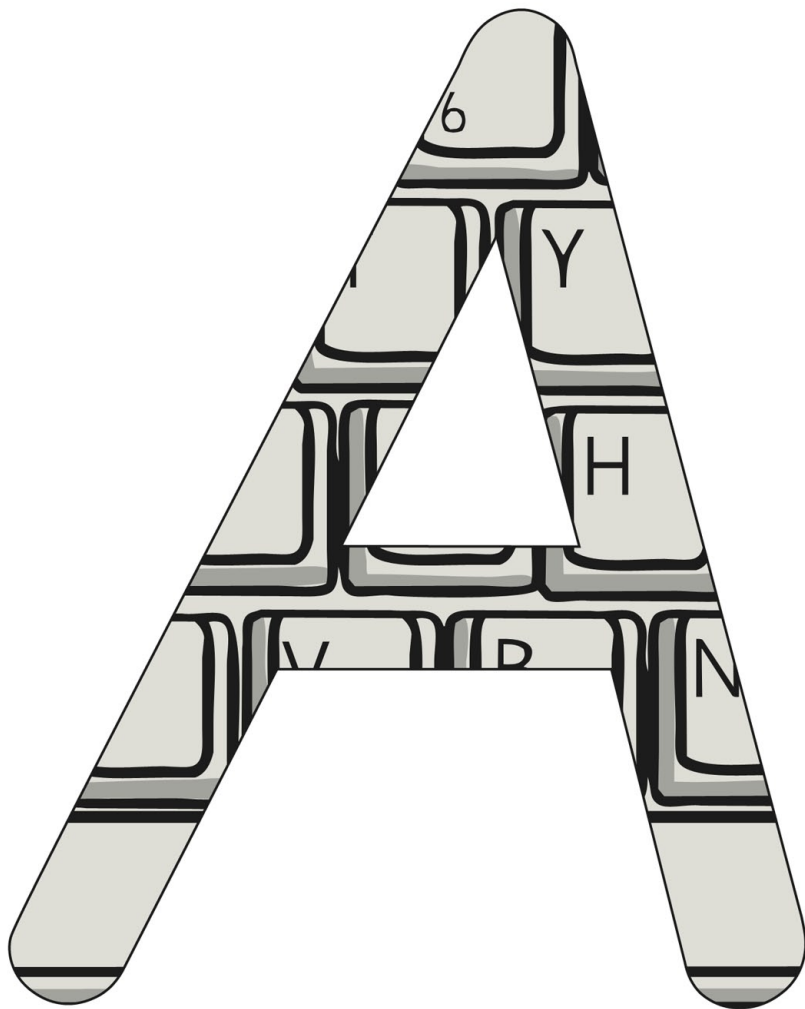

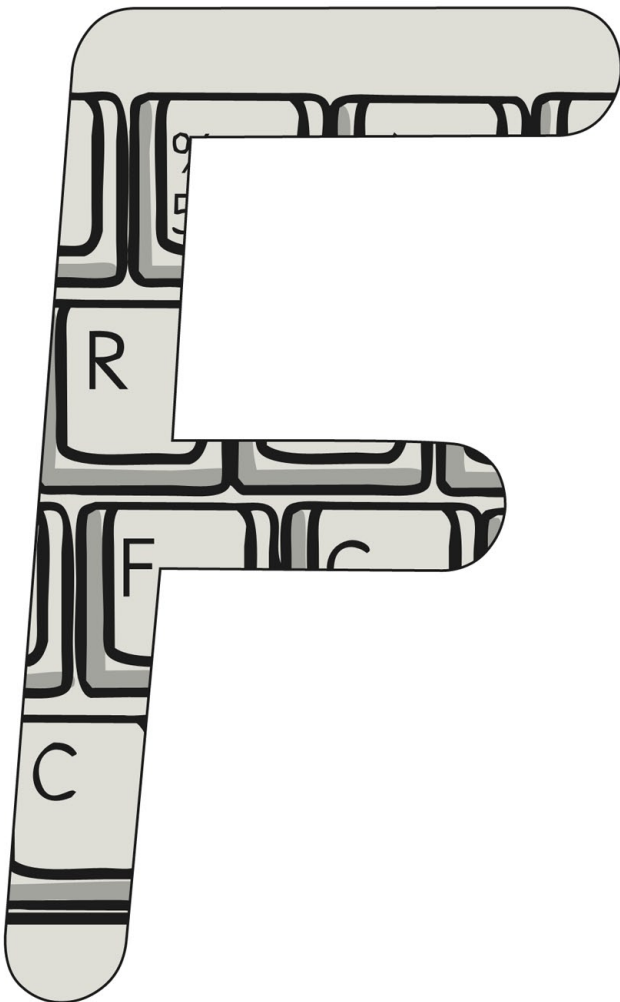
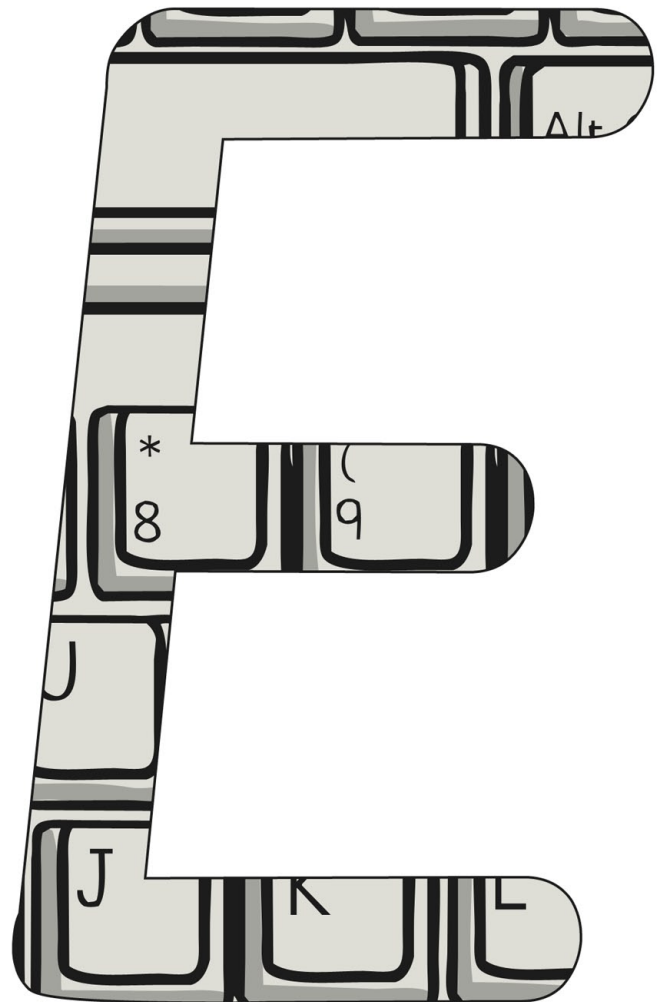
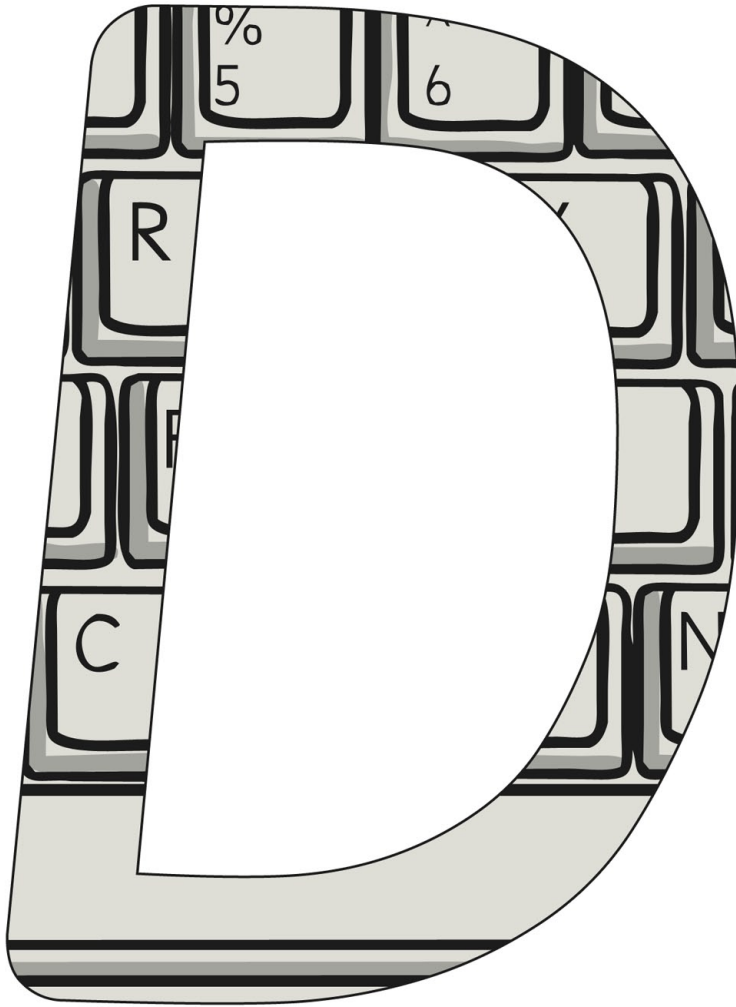



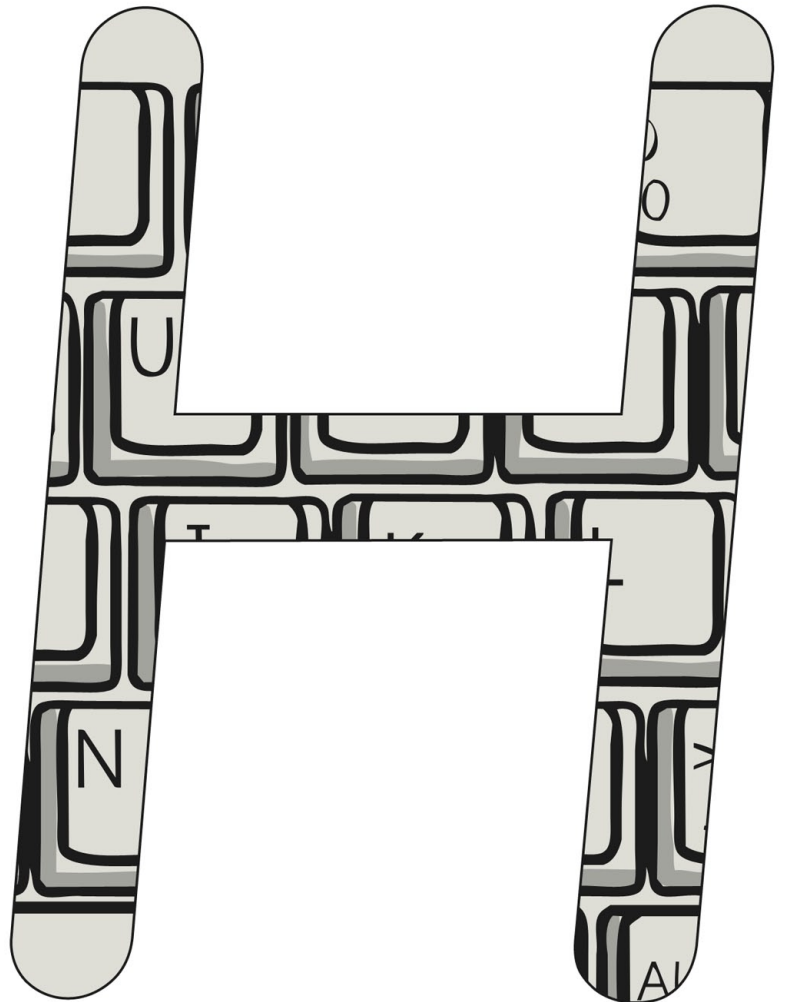
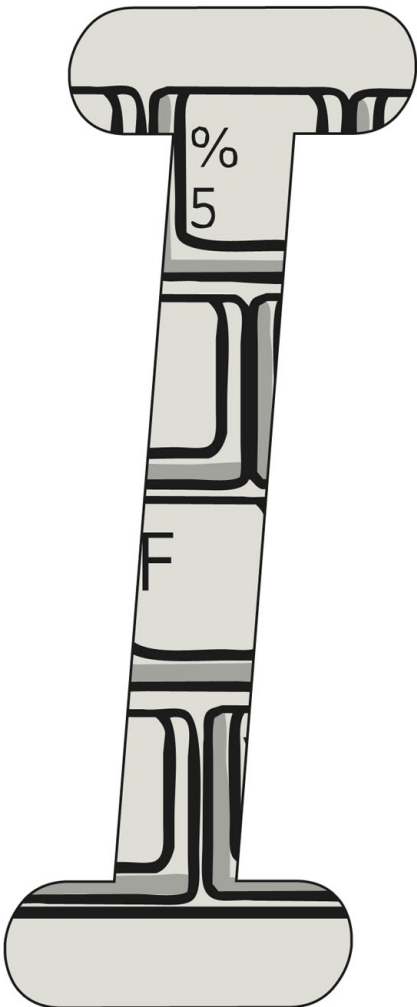
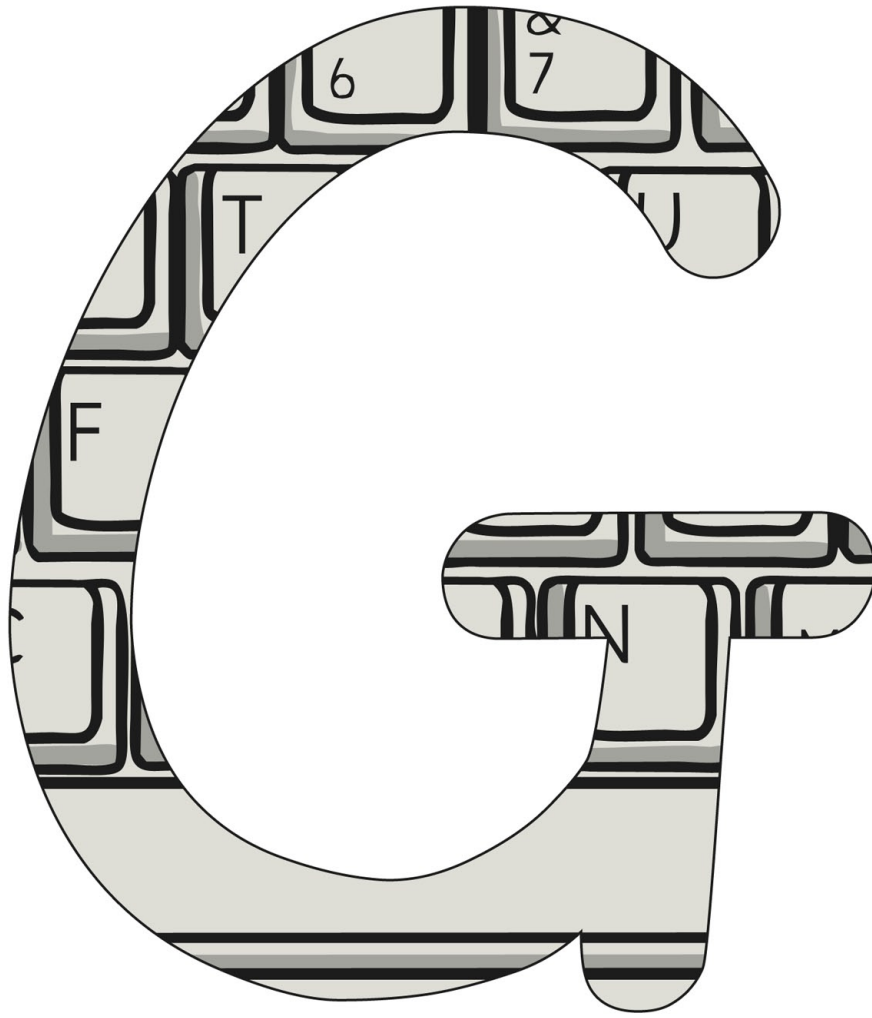

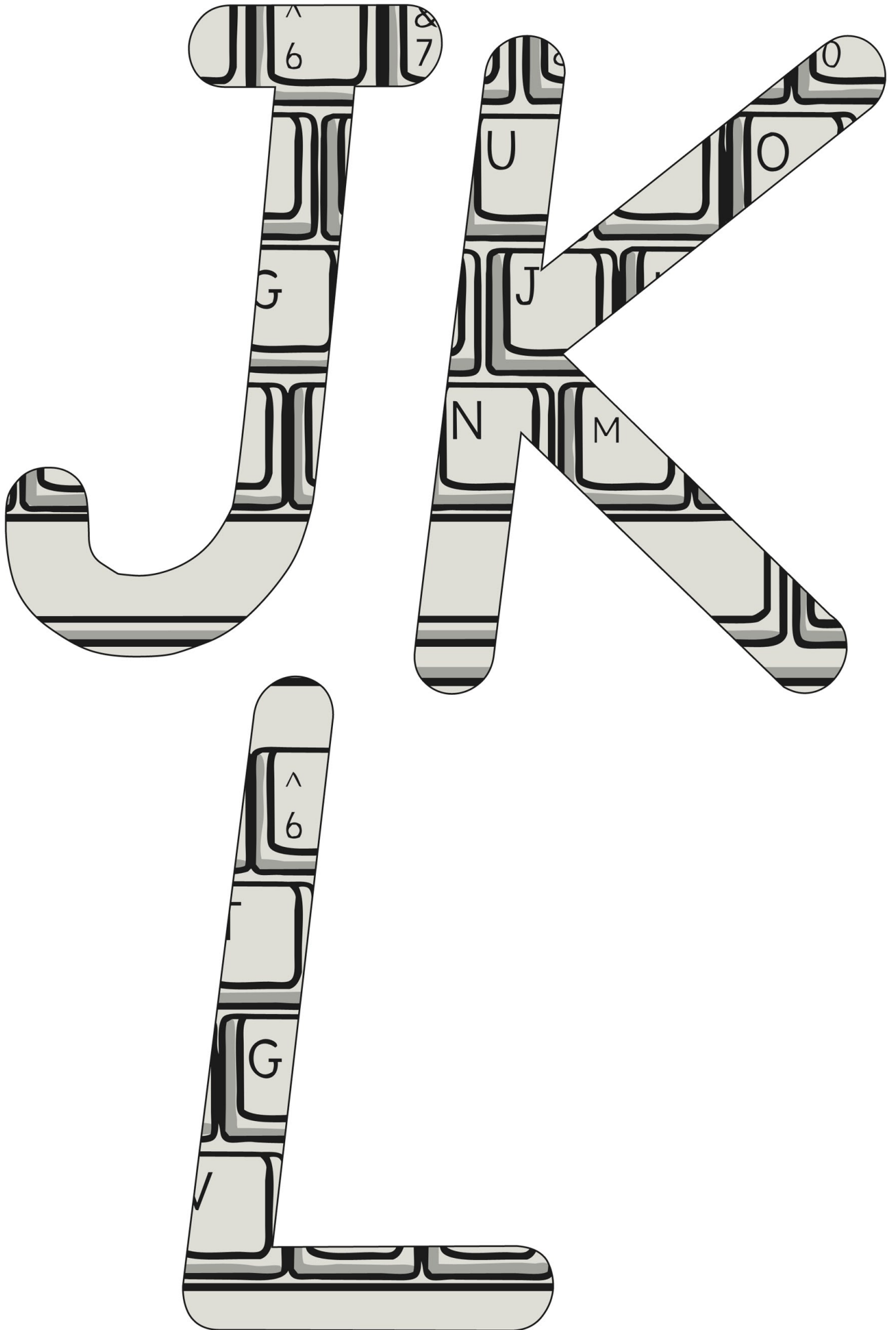







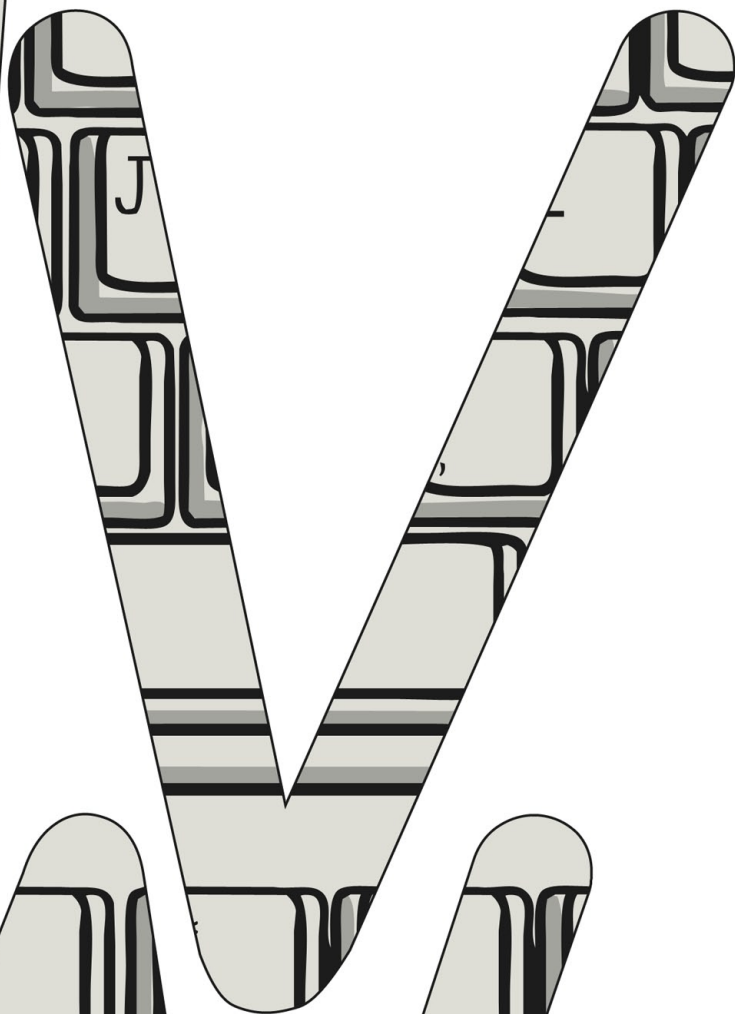
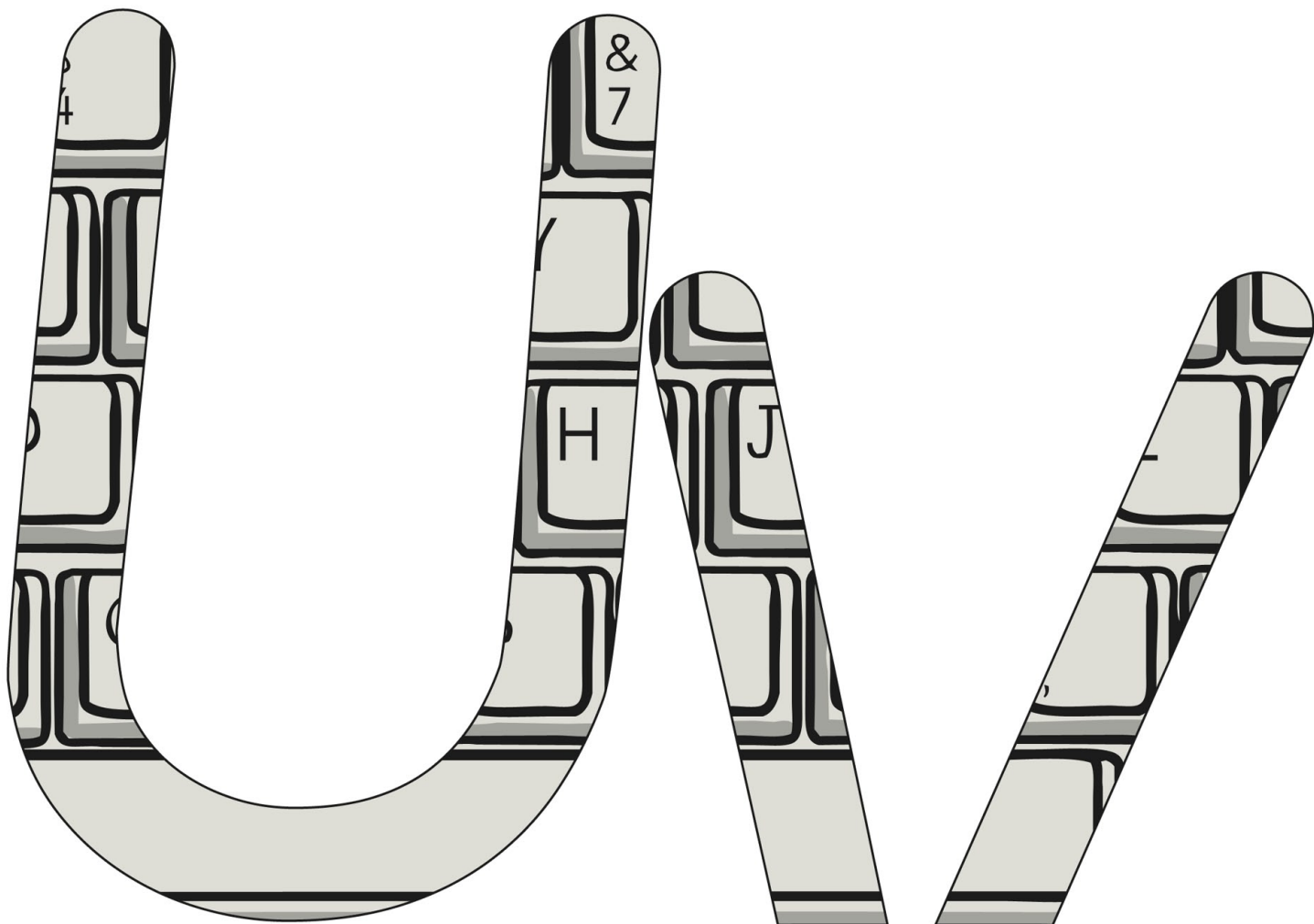

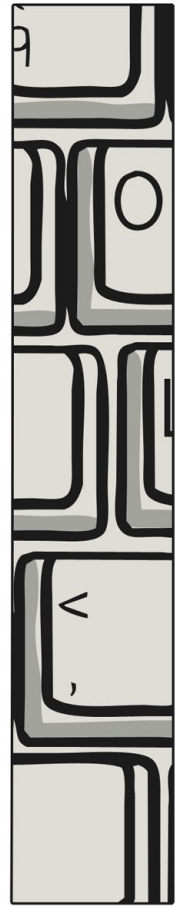





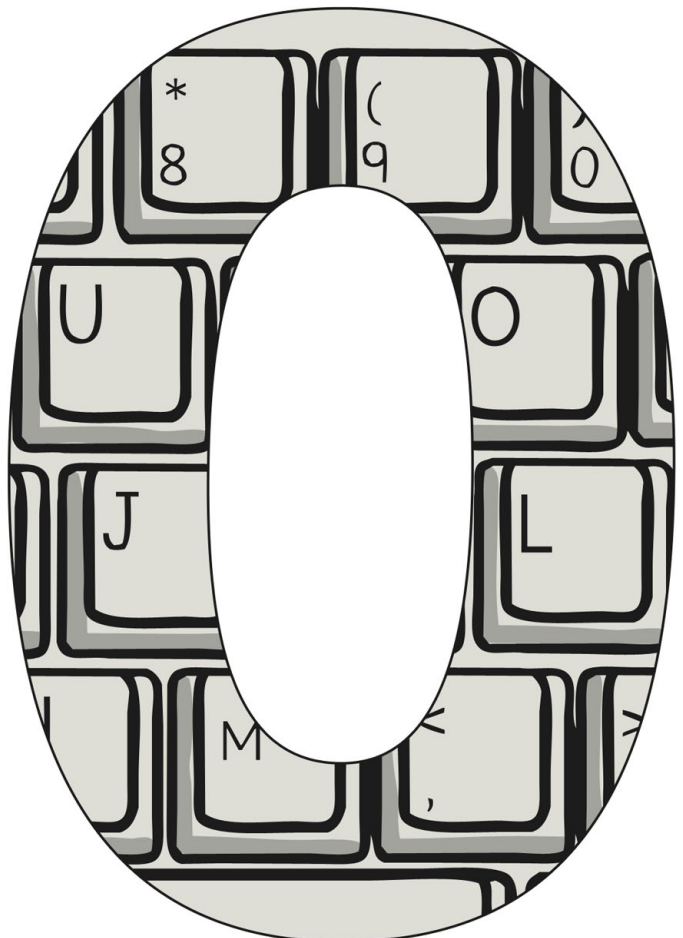
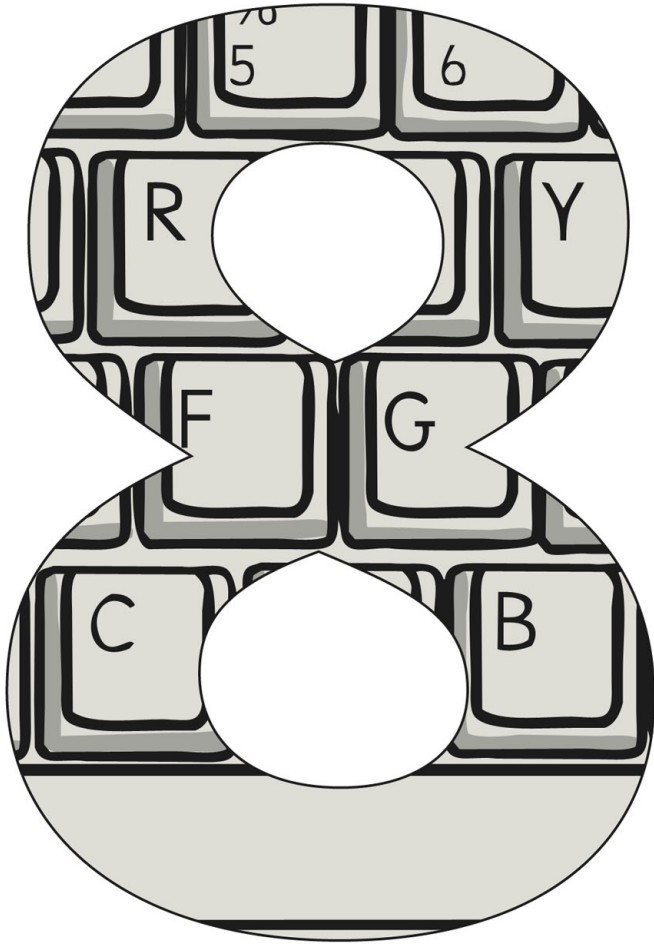

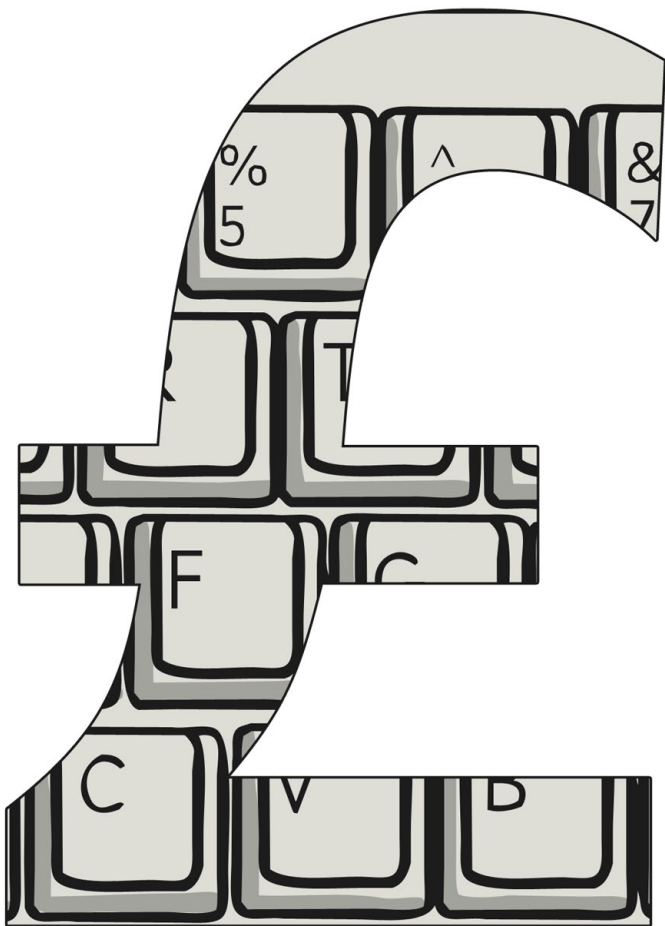
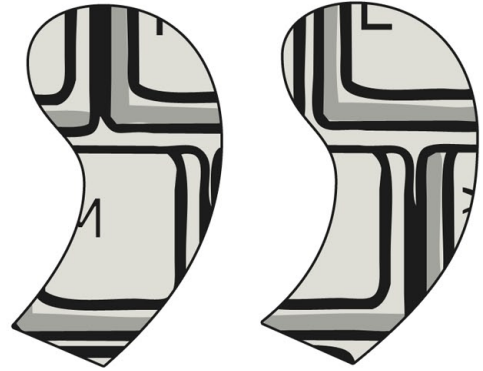
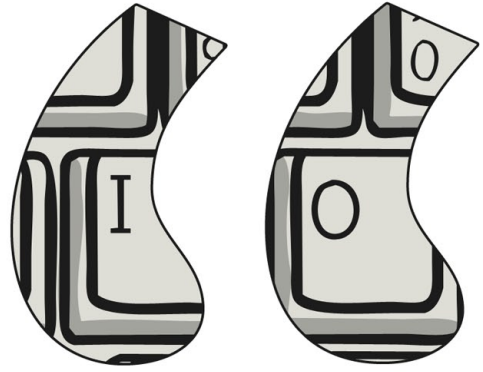

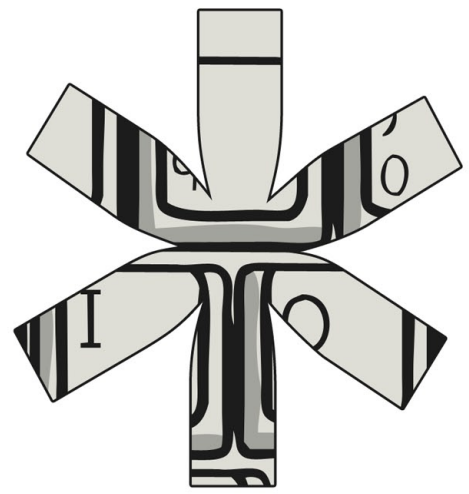
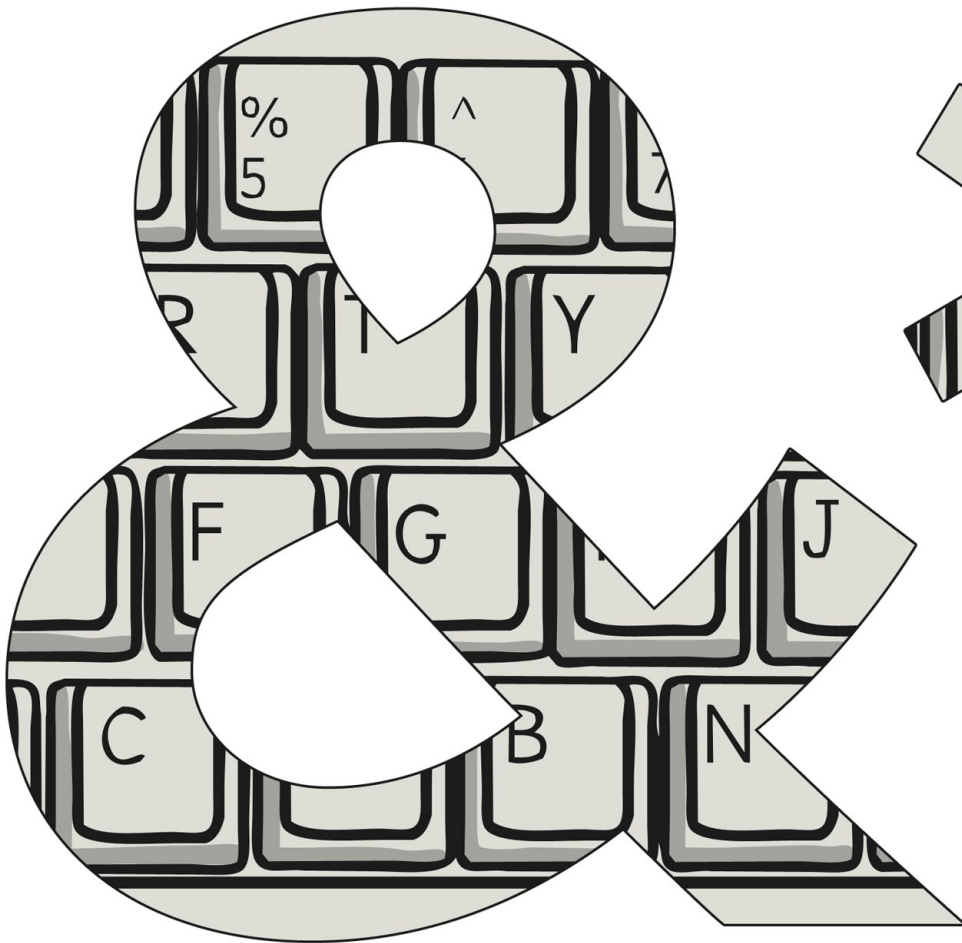
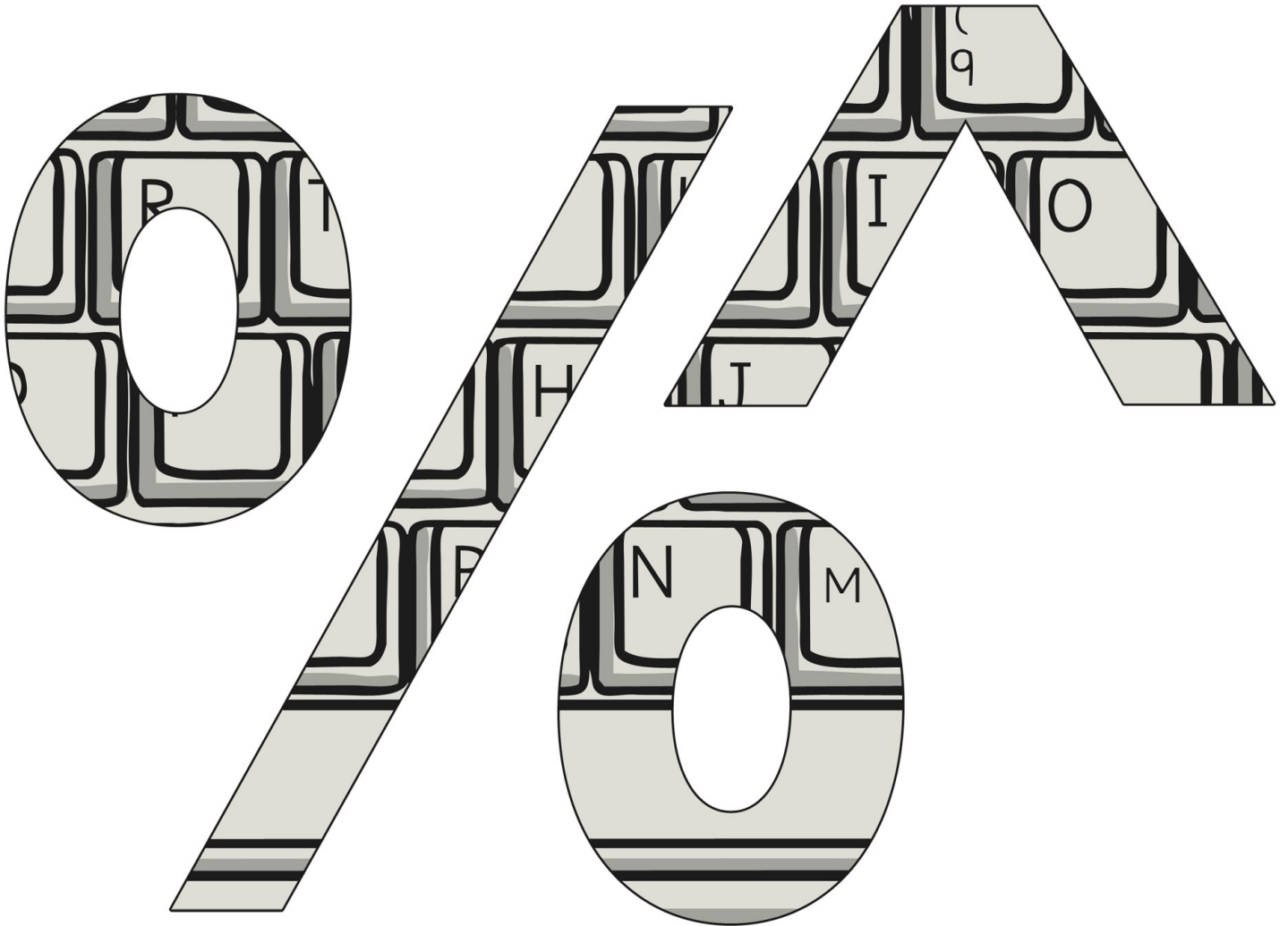

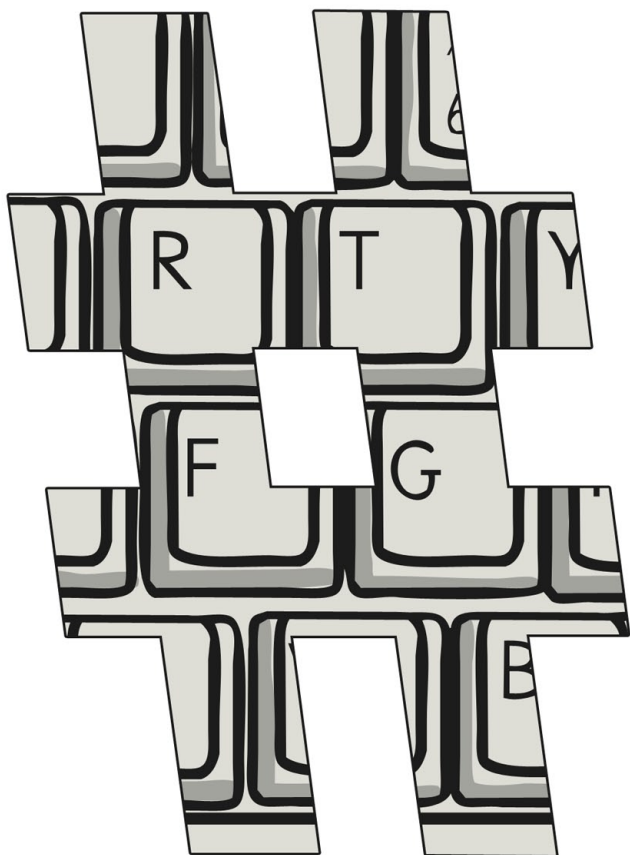
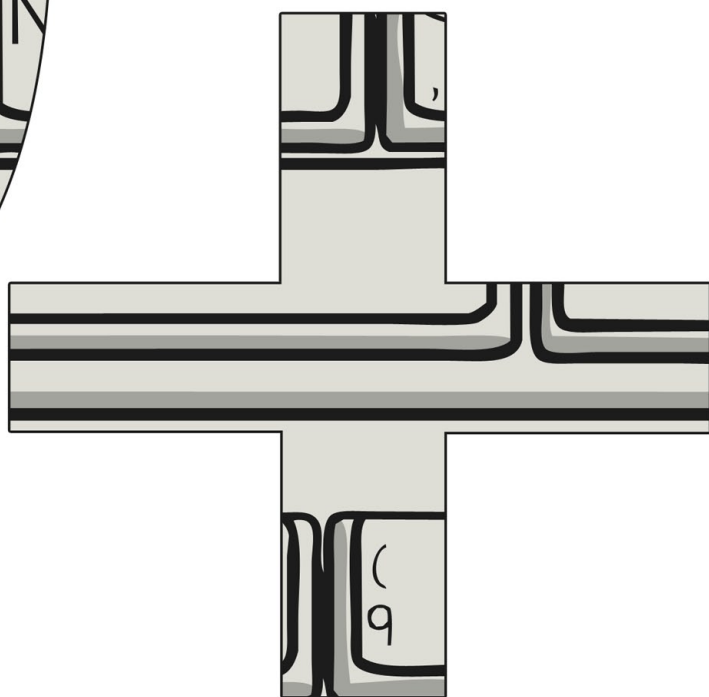
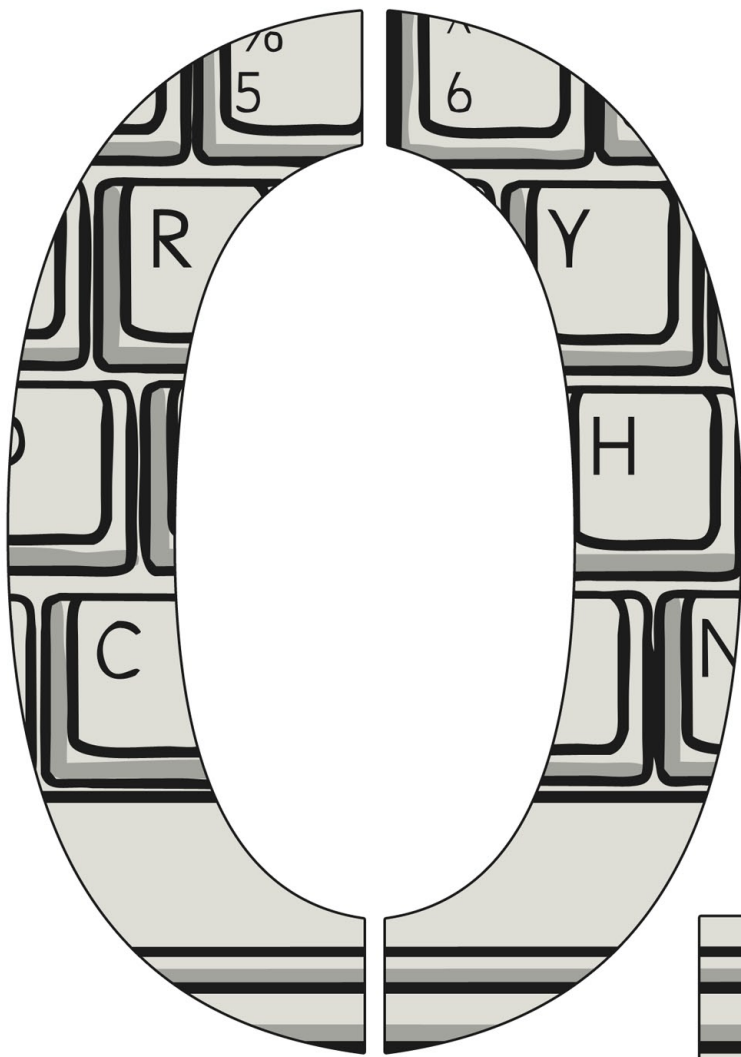

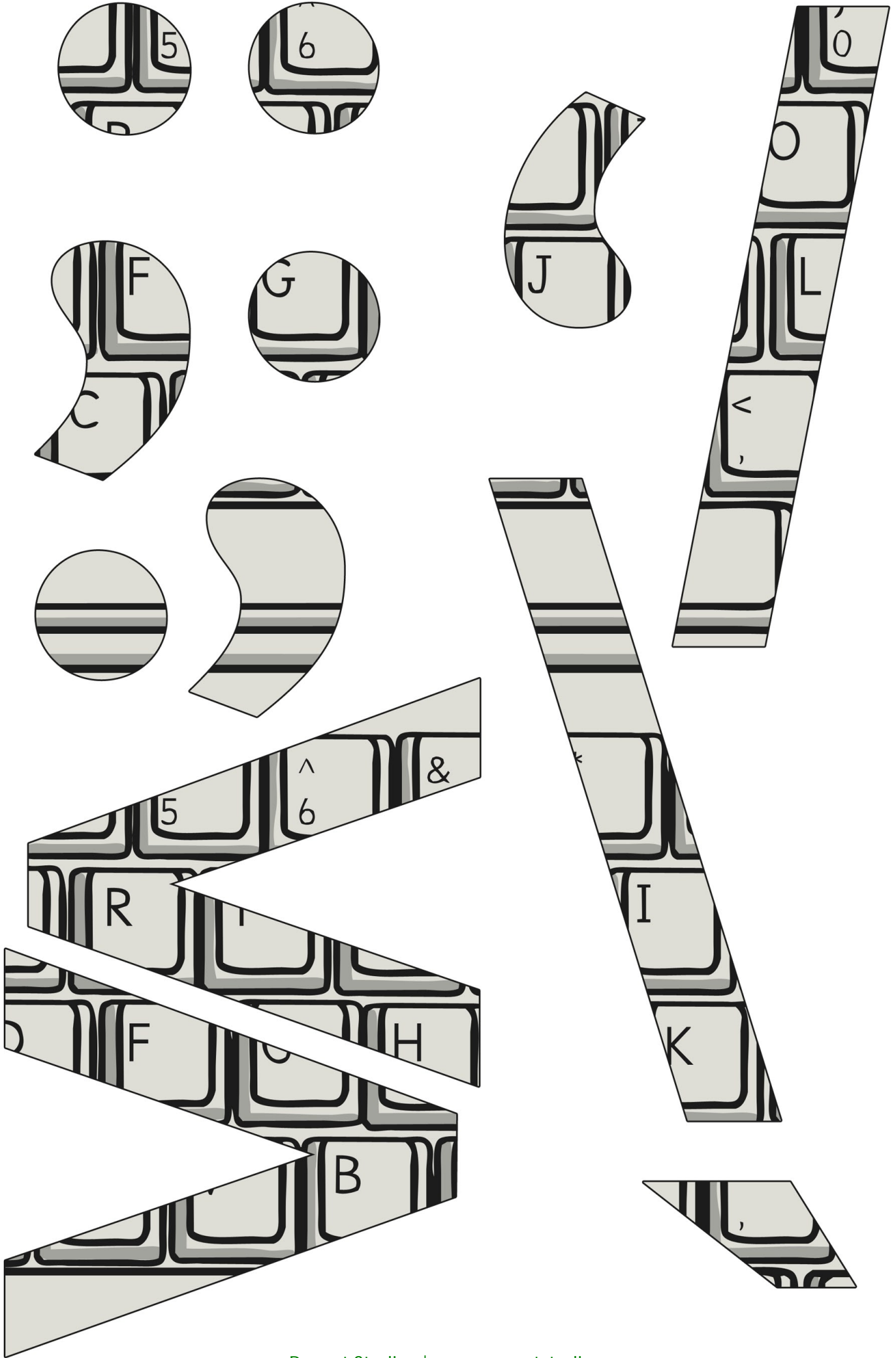

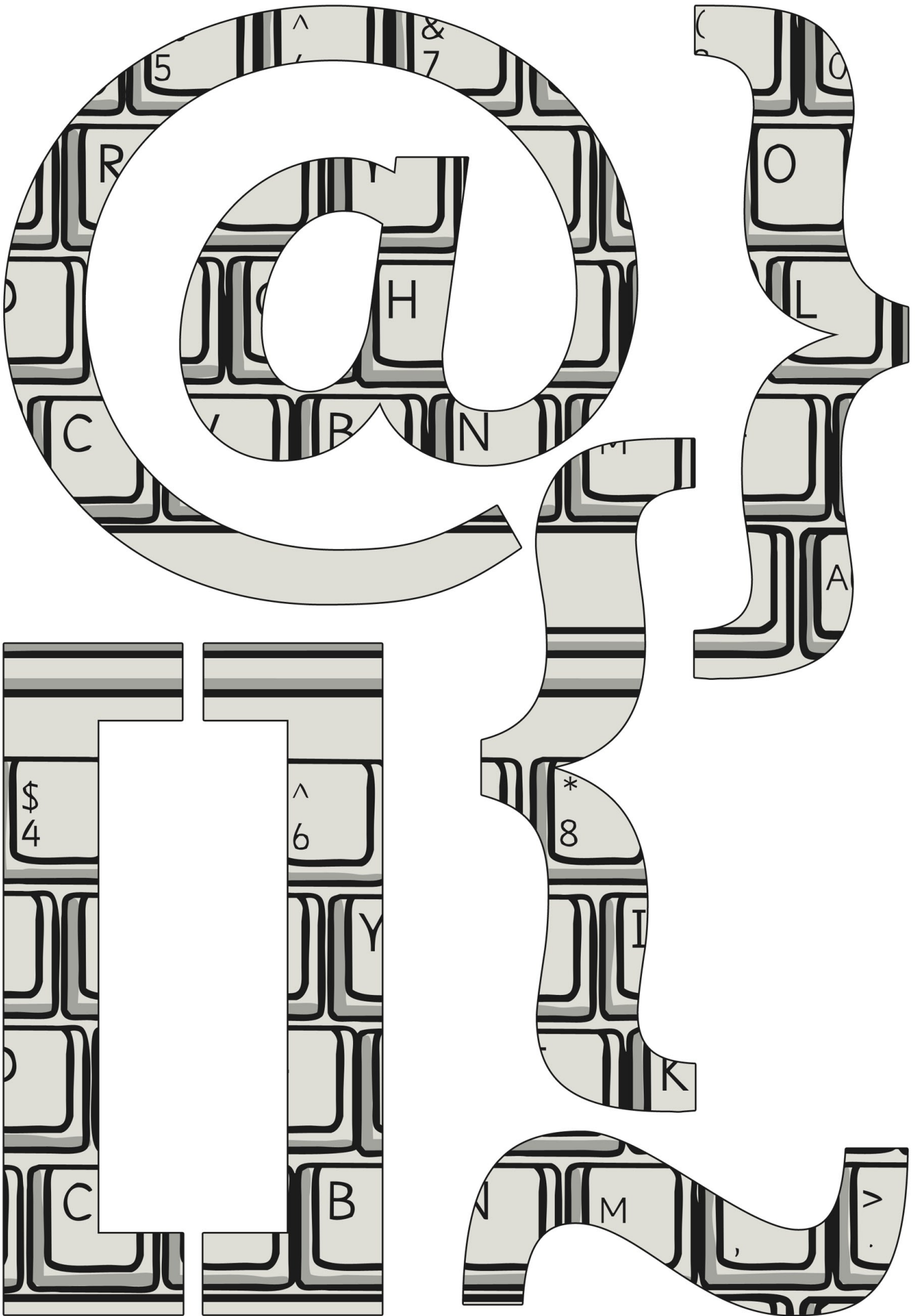

keyboard



typing



save

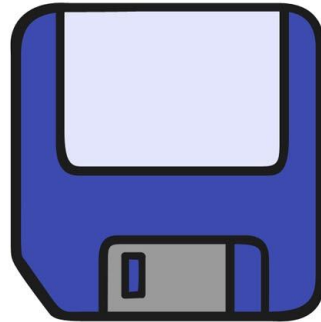

folder

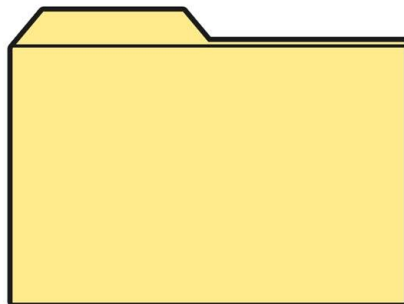

*shift*

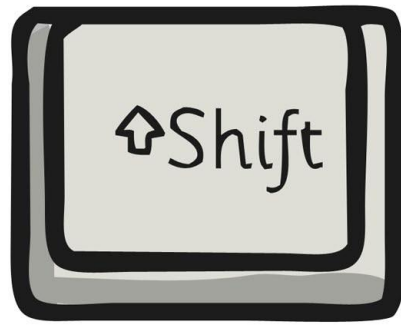

*Caps Lock*



*space bar*



*edit*





*backspace*

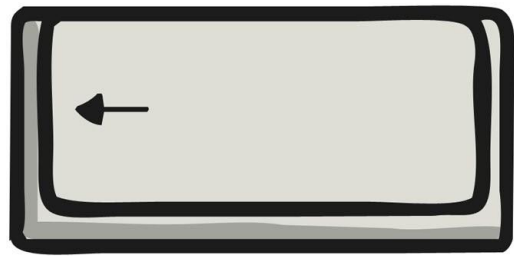

*delete*

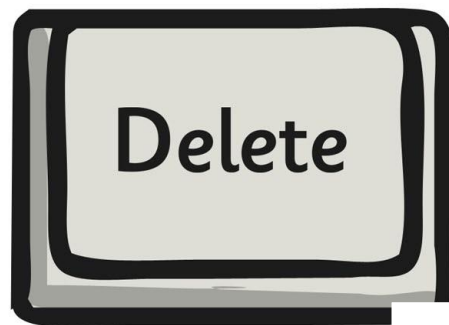

*arrow keys*

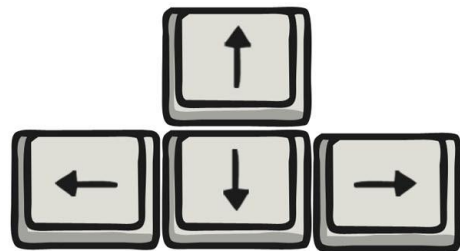

*undo*

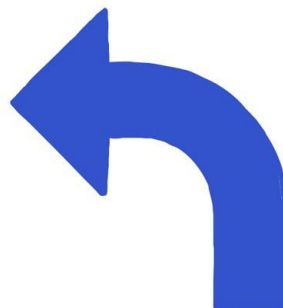

*redo*

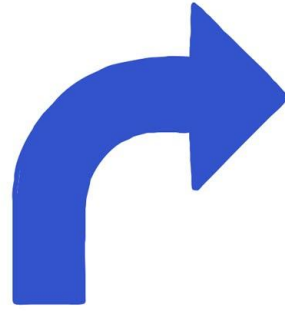

*select*

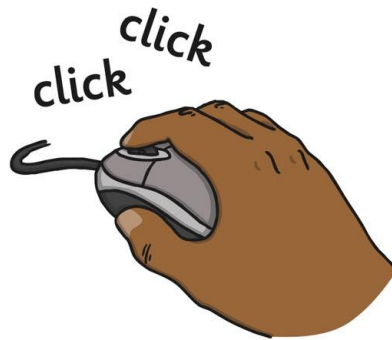

*window*

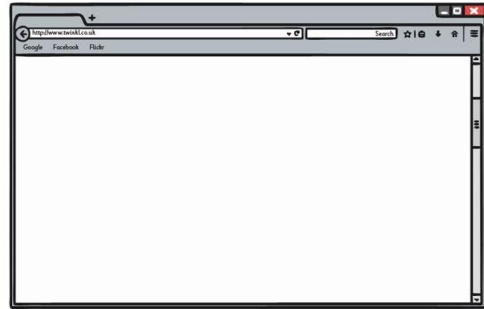

*minimise*

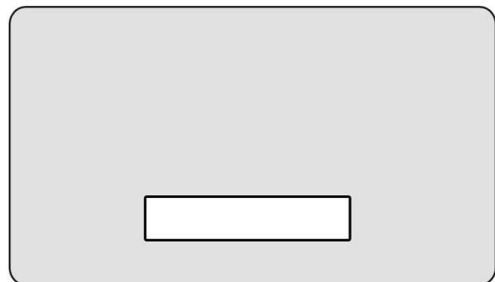

password



screenshot

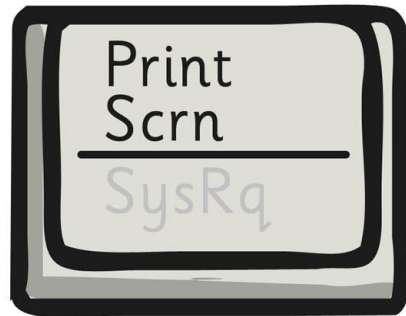

snipping tool

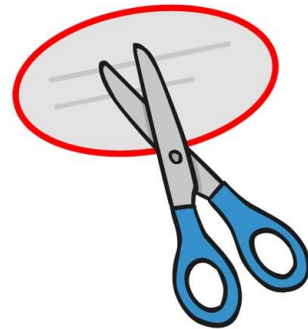

shortcut

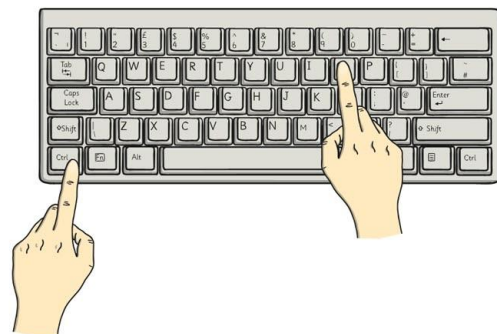

# keyboard



# typing



# save

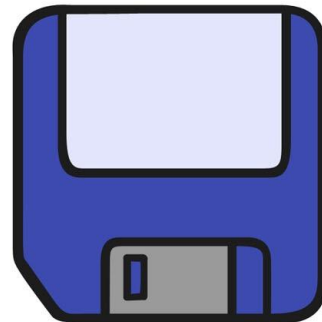

# folder

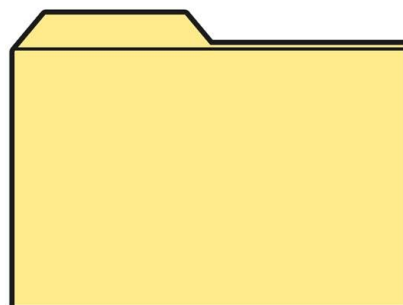

shift

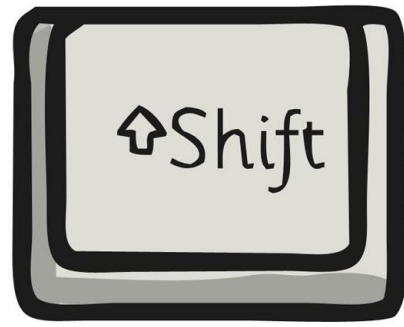

Caps Lock



space bar



edit



**backspace**

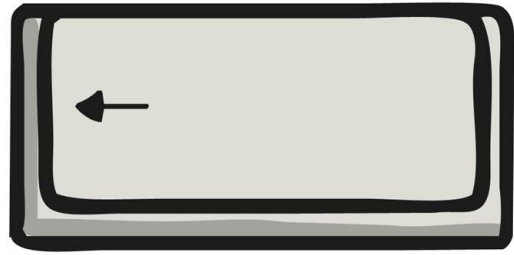

**delete**

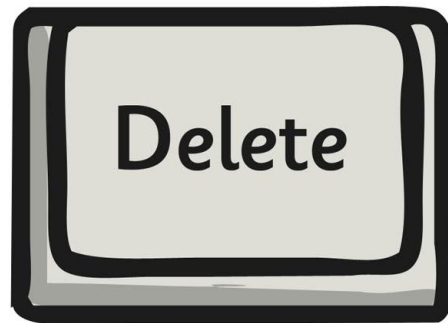

**arrow keys**

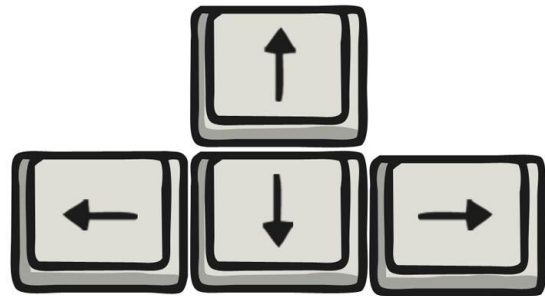

**undo**

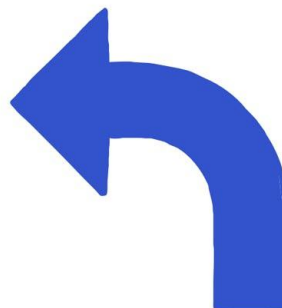

**redo**

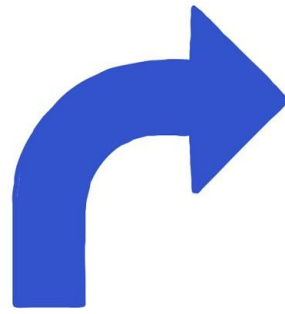

**select**

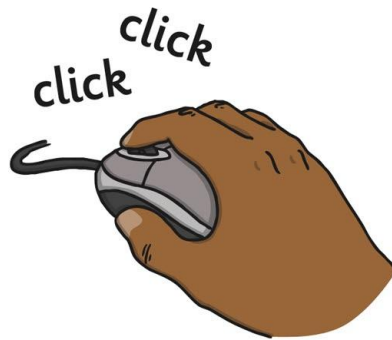

**window**

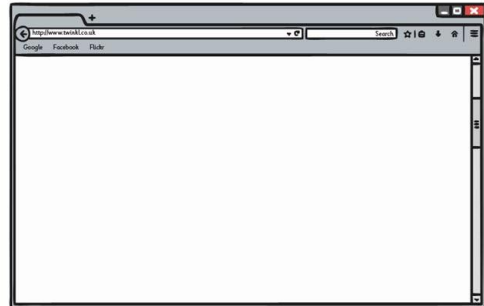

**minimise**

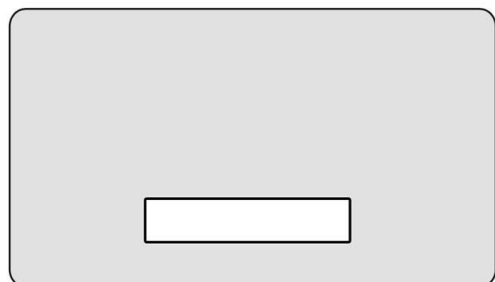

# password



# screenshot

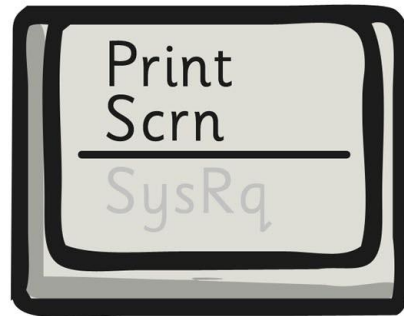

# snipping tool

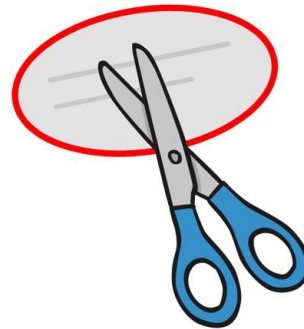

# shortcut

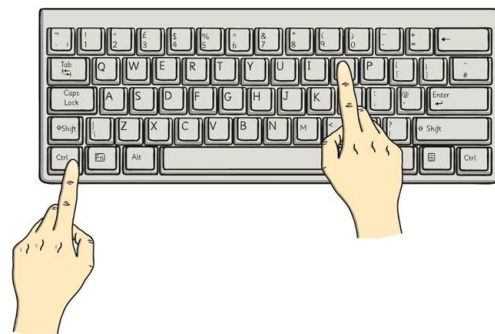



# Word Processing Skills



keyboard



typing

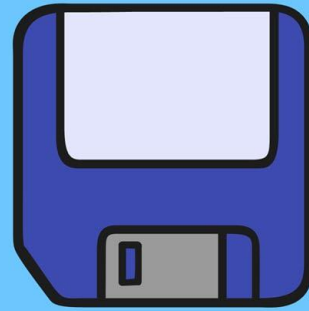

save

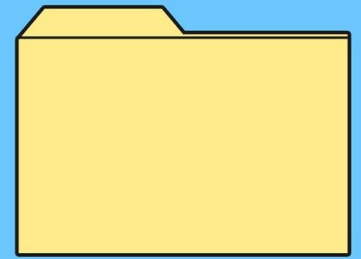

folder



shift

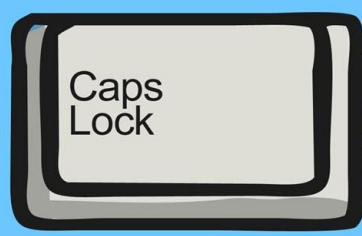

Caps Lock



space bar



edit

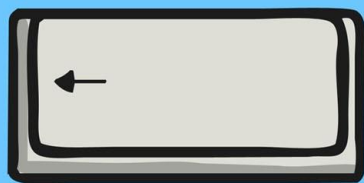

backspace

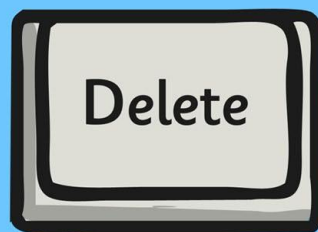

delete

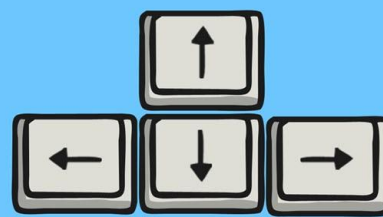

arrow keys



undo



redo

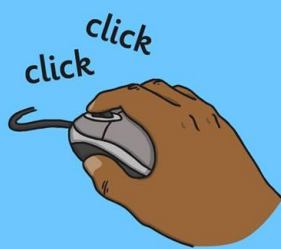

select

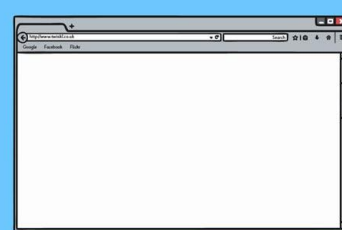

window



minimise



password



screenshot

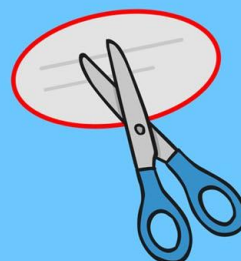

snipping tool



shortcut

# Word Processing Skills



keyboard



typing

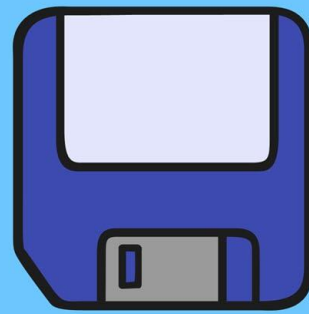

save

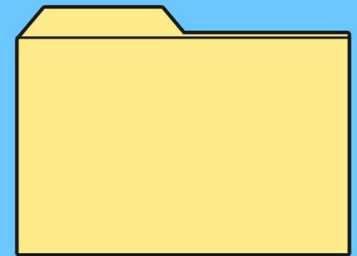

folder



shift

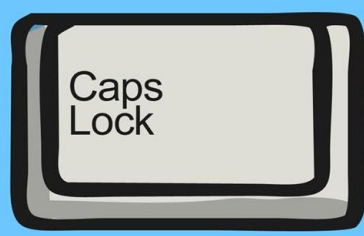

Caps Lock



space bar



edit

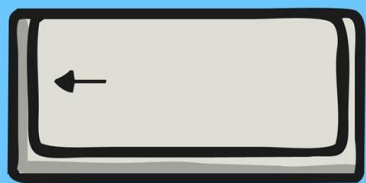

backspace



delete



arrow keys



undo



redo

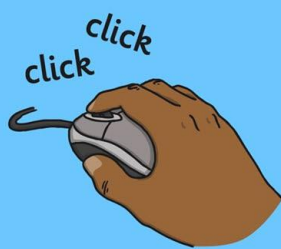

select



window



minimise



password

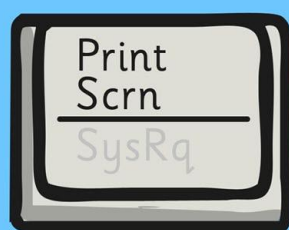

screenshot

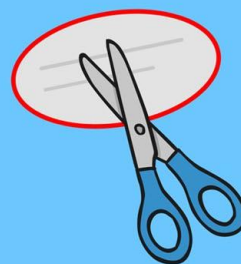

snipping tool



shortcut

# Word Processing Skills



keyboard



typing

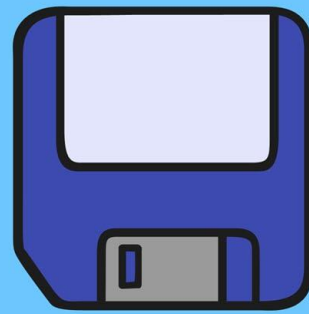

save

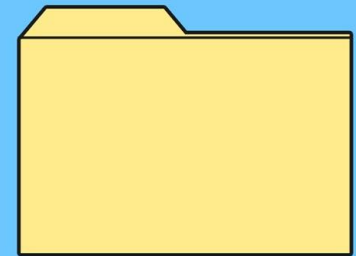

folder



shift

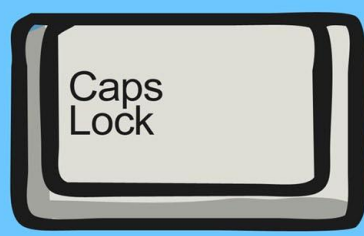

Caps Lock



space bar



edit

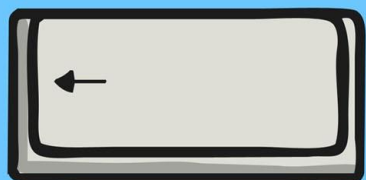

backspace

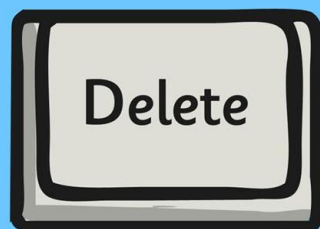

delete

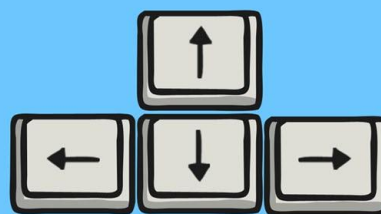

arrow keys



undo



redo



select



window



minimise



password



screenshot

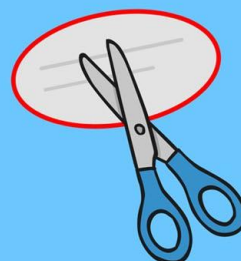

snipping tool



shortcut

# Word Processing Skills



keyboard



typing

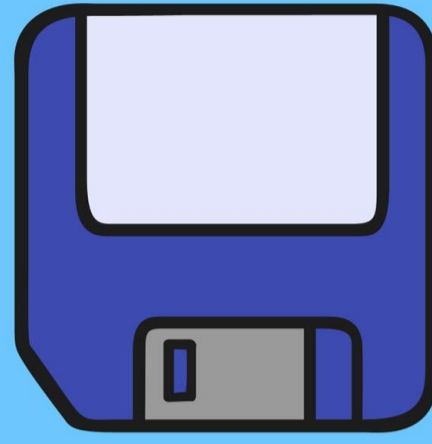

save

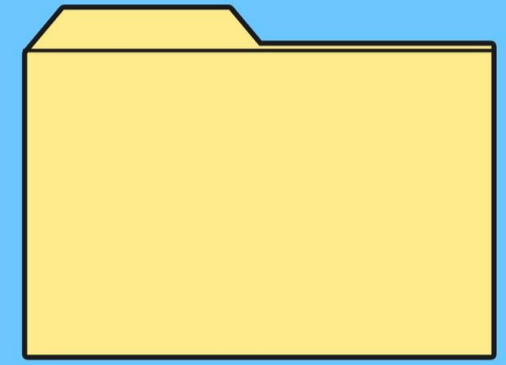

folder

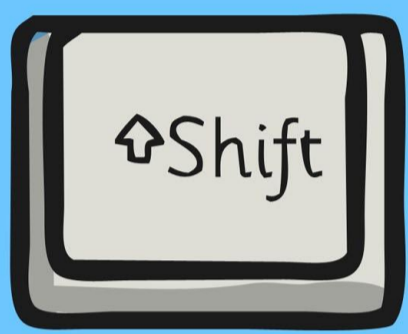

shift

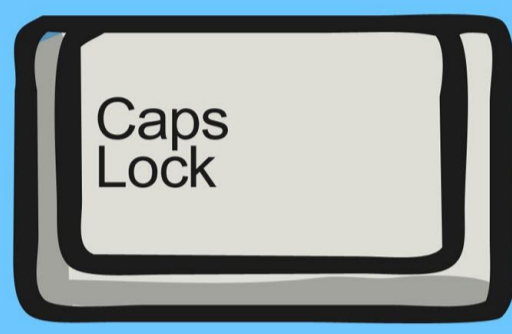

Caps Lock

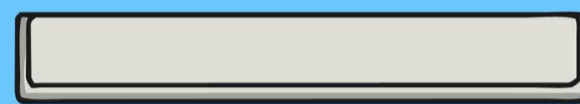

space bar



edit

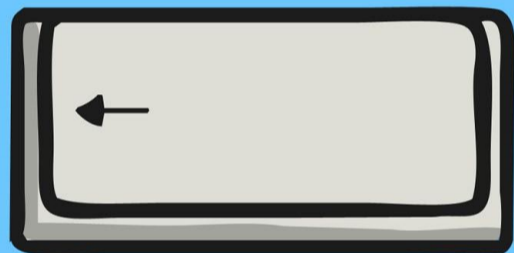

backspace

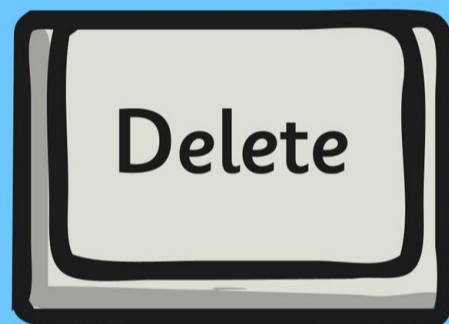

delete

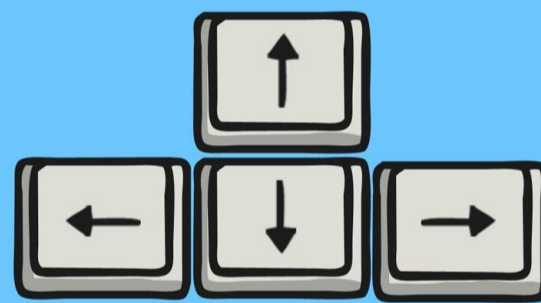

arrow keys



undo



redo

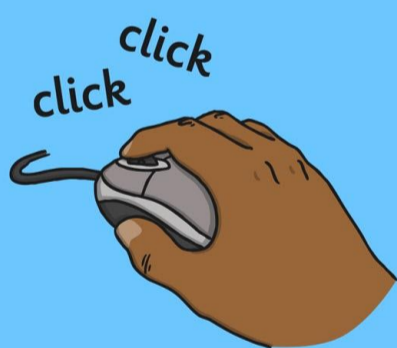

select

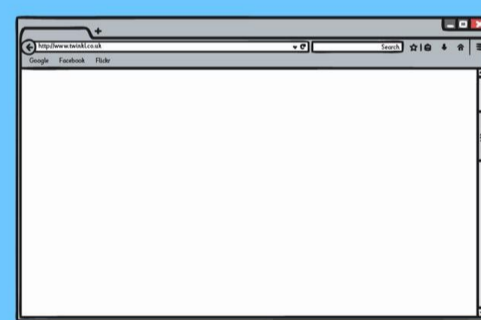

window



minimise



password

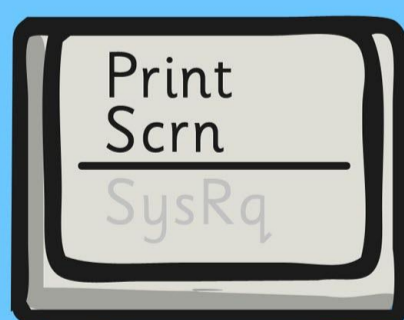

screenshot

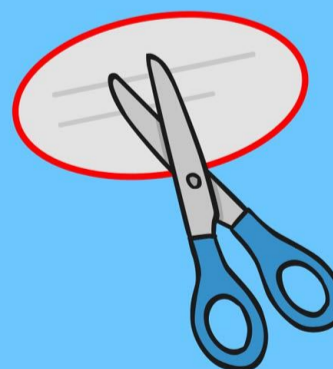

snipping tool



shortcut

# Word Processing Skills



keyboard



typing

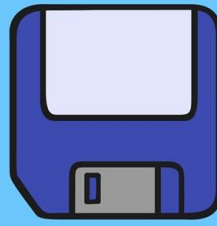

save



folder



shift

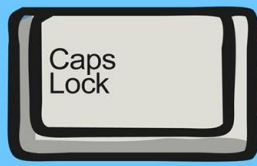

Caps Lock



space bar



edit



backspace

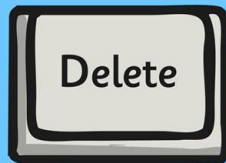

delete

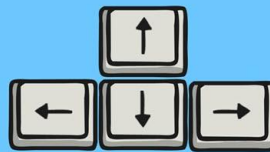

arrow keys



undo



redo



select



window



minimise



password

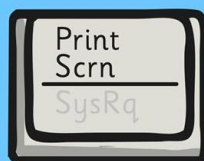

screenshot



snipping tool



shortcut

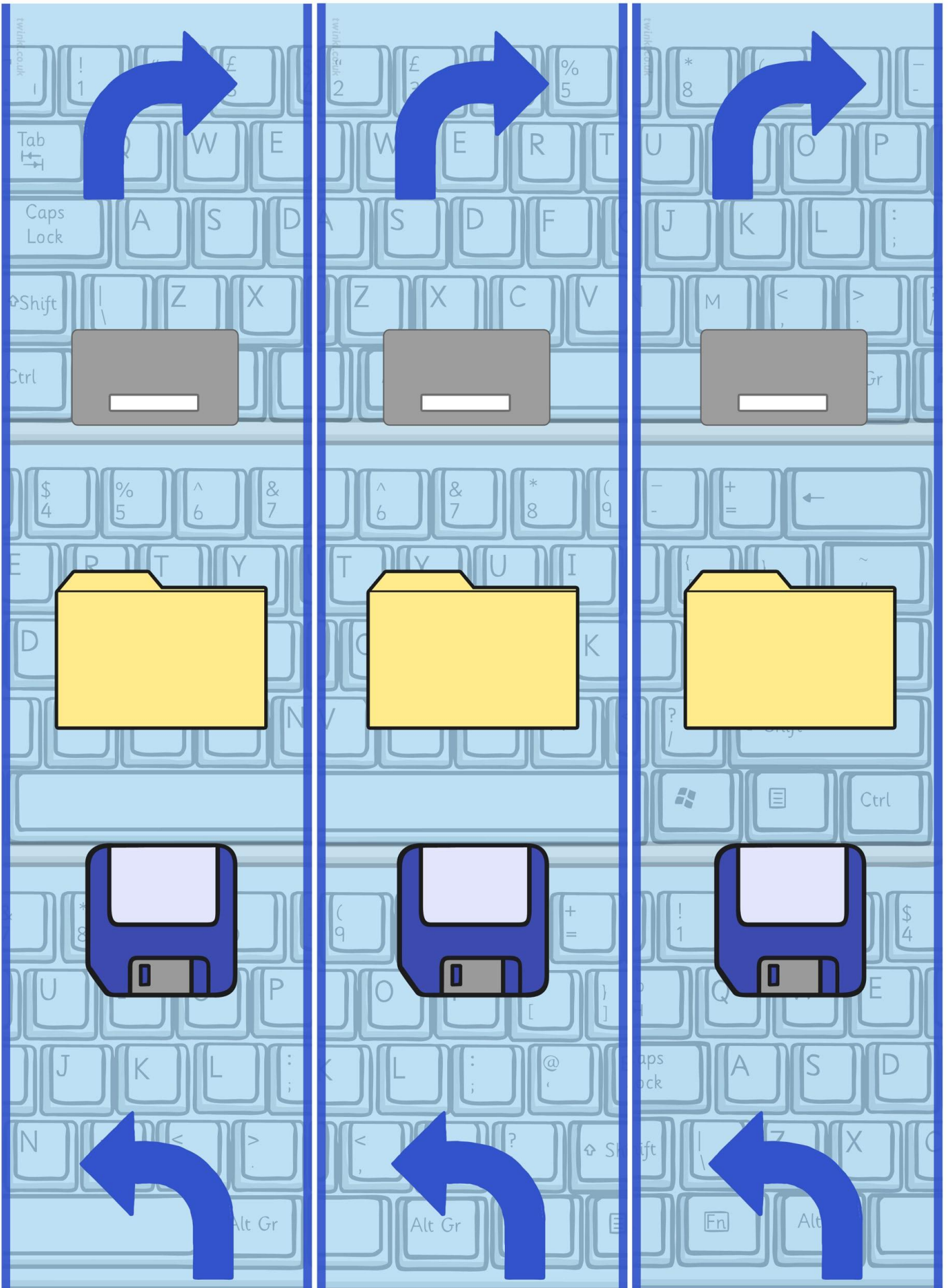

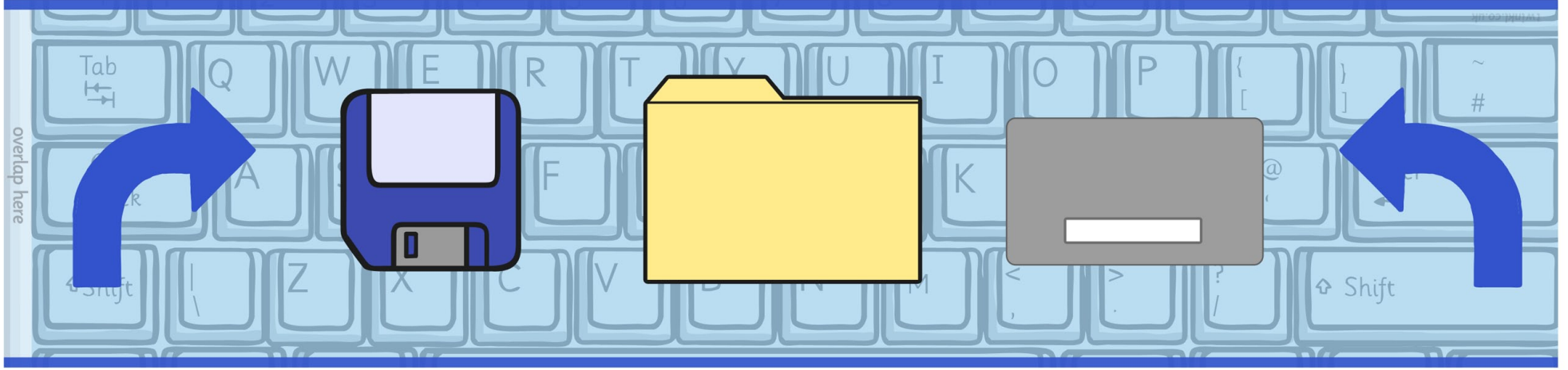
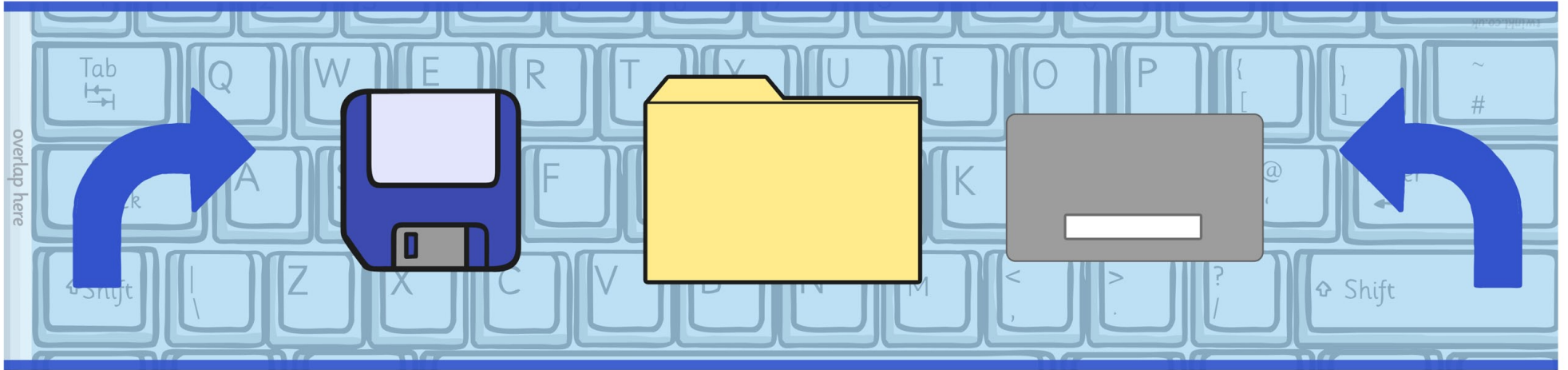
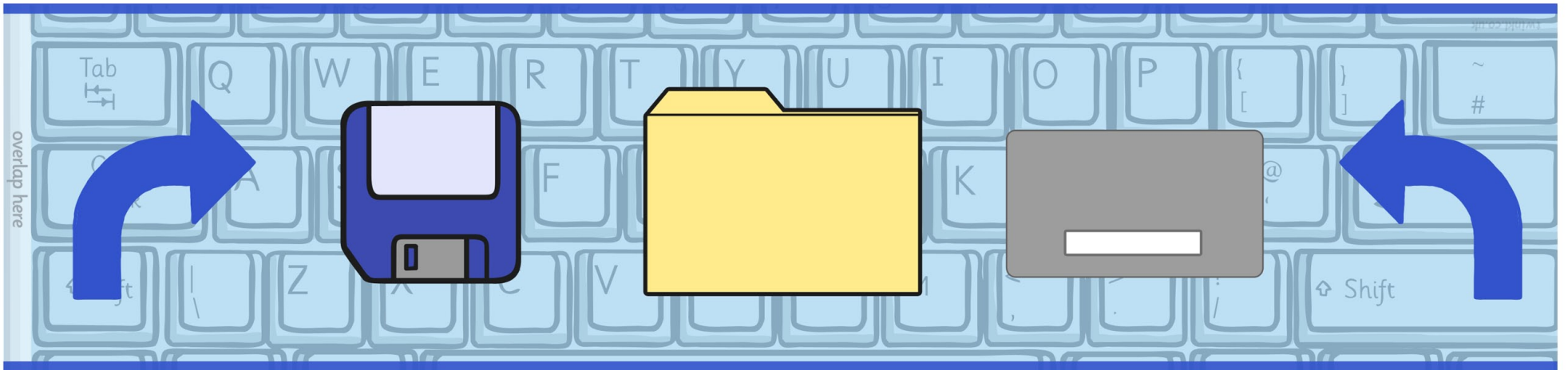

# Word Processing Skills

s e l e c t t e h d s s  
a d b k u n k d a n o p  
b e a r t y p i n g o a  
i l c g y i u t m e m c  
l e k b a g k w a r n e  
i t s e n a r e d o d b  
c e p t s e s h i f t a  
d r a w k c a b d m e r  
i o c l o j v u n d o n  
o w e a t y e o e i n i  
u f o l d e r h e d a t  
s p h c a p s l o c k l

typing  
save  
folder  
shift  
caps lock  
space bar

edit  
undo  
redo  
select  
backspace  
delete



# Word Processing Skills

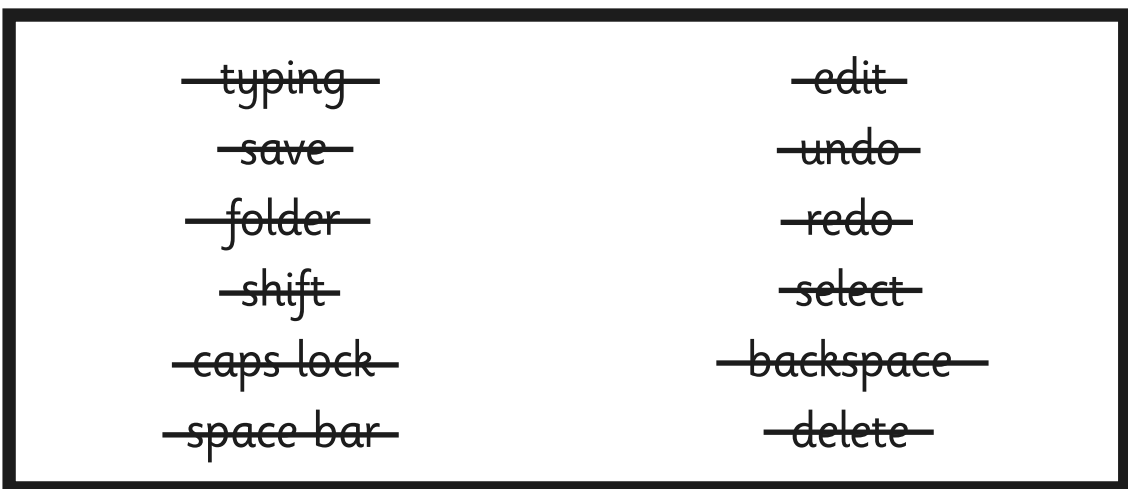
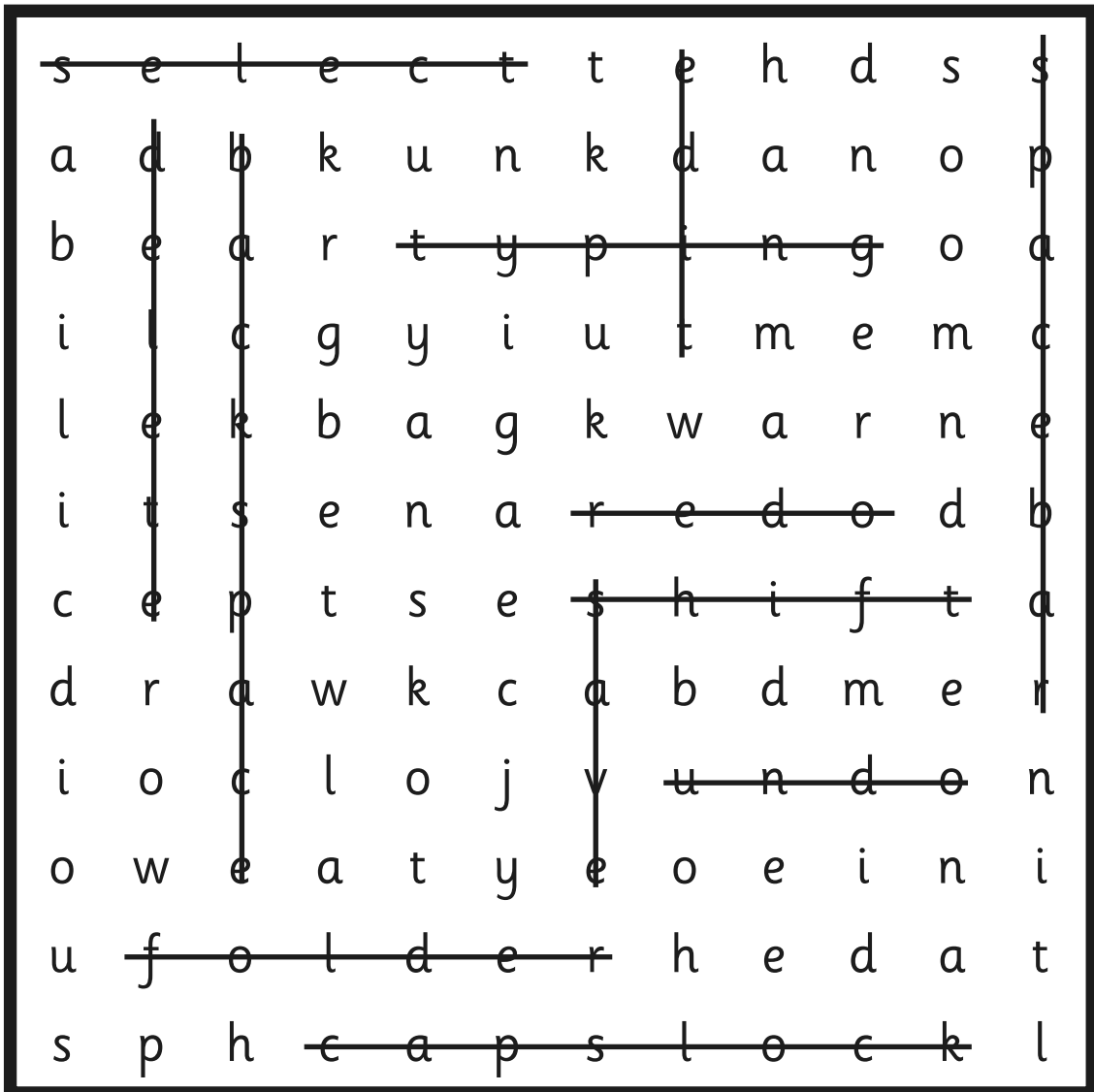

# Word Processing Skills

d e i f i t s u j d m m  
e r t n e c p t y u e p  
h u c a p i t a l s n t  
m s y e k w o r r a u l  
k a e r u l e r e y b o  
e v l e f t t e l f u w  
y e a t r i n d e n t e  
b u l l e t p o i n t r  
o w y e k l o r t n o c  
a a t u c t r o h s n a  
r i g h t f f o c l s s  
d u p p e r c a s e l e

save	capitals
shortcut	uppercase
indent	lowercase
bullet point	control key
justified	arrow keys
centre	keyboard
left	menu buttons
right	ruler

# Word Processing Skills

d e i f i t s u j d m m  
e r t n e c p t y u e p  
h u c a p i t a l s n t  
m s y e k w o r r a u l  
k a e r u l e r e y b o  
e y t e f t t e l f u w  
y e a t r i n d e n t e  
b u l l e t p o i n t r  
o w y e k l o r t n o c  
a a t u c t r o h s n a  
r i g h t f f o c l s s  
d u p p e r c a s e l e

~~save~~  
~~shortcut~~  
~~indent~~  
~~bullet point~~  
~~justified~~  
~~centre~~  
~~left~~  
~~right~~  
~~capitals~~  
~~uppercase~~  
~~lowercase~~  
~~control key~~  
~~arrow keys~~  
~~keyboard~~  
~~menu buttons~~  
~~ruler~~

# Word Processing Skills

s e l e c t t e h d s s  
a d b k u n k d a n o p  
b e a r t y p i n g o a  
i l c g y i u t m e m c  
l e k b a g k w a r n e  
i t s e n a r e d o d b  
c e p t s e s h i f t a  
d r a w k c a b d m e r  
i o c l o j v u n d o n  
o w e a t y e o e i n i  
u f o l d e r h e d a t  
s p h c a p s l o c k l

typing  
save  
folder  
shift  
caps lock  
space bar

edit  
undo  
redo  
select  
backspace  
delete

# Word Processing Skills

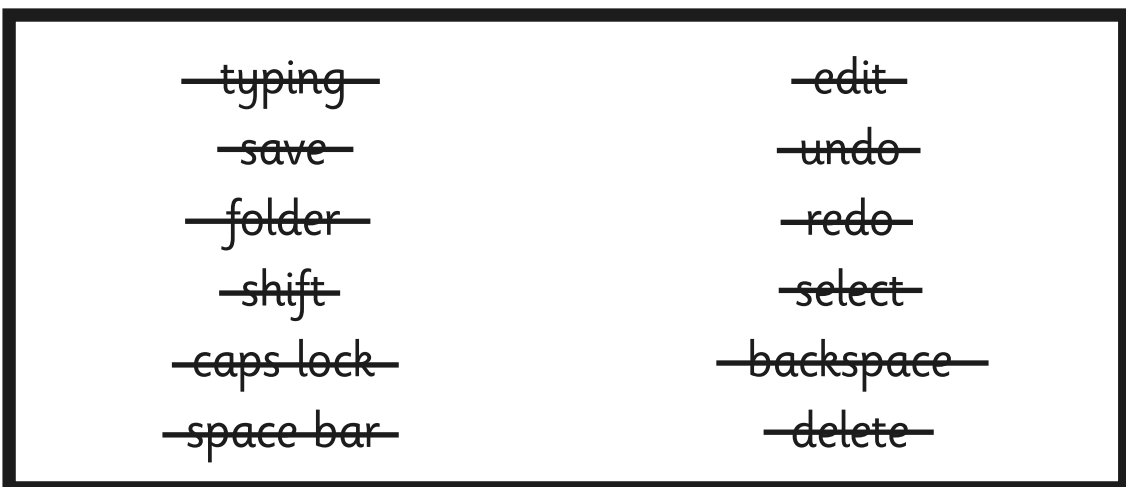
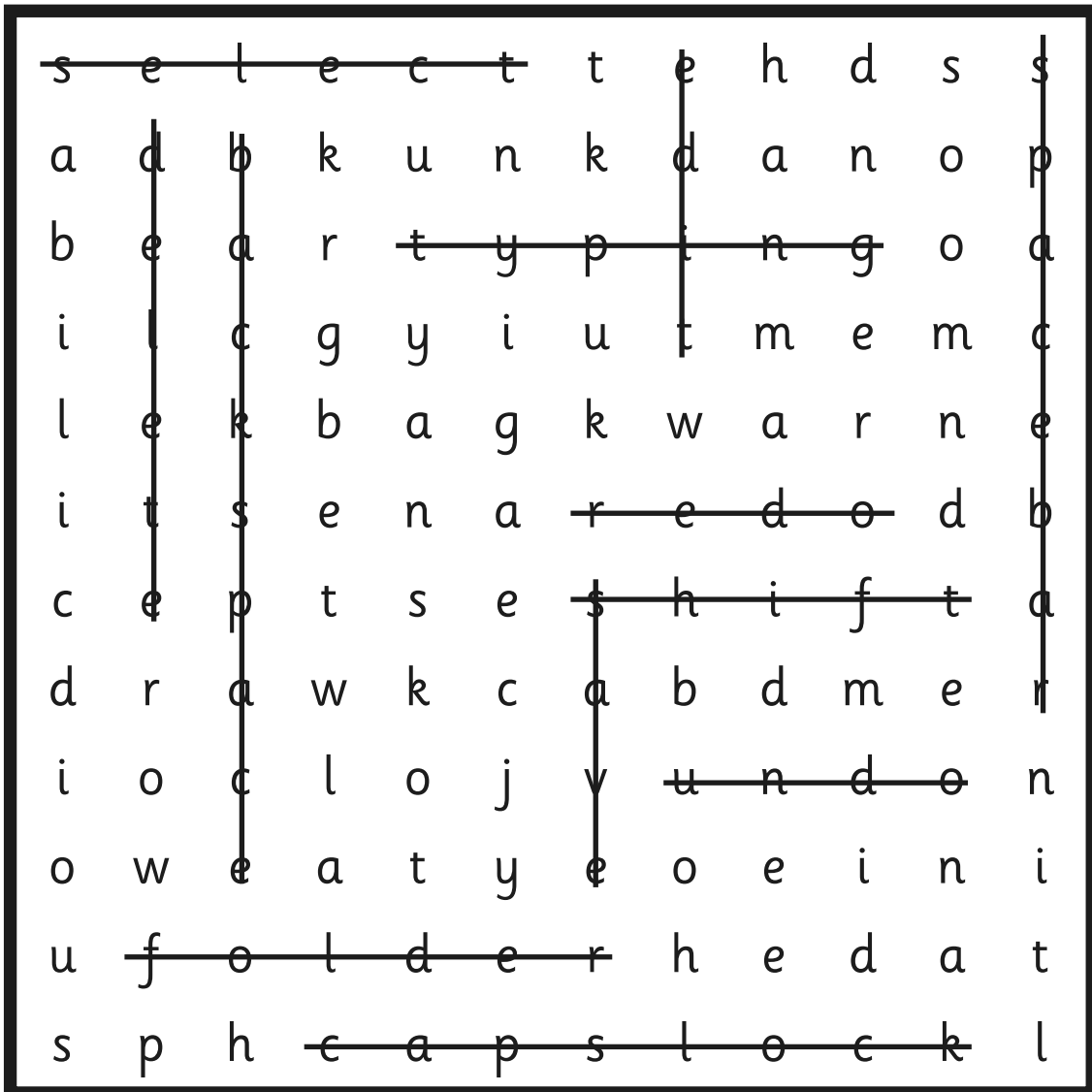

# Word Processing Skills

d e i f i t s u j d m m  
e r t n e c p t y u e p  
h u c a p i t a l s n t  
m s y e k w o r r a u l  
k a e r u l e r e y b o  
e v l e f t t e l f u w  
y e a t r i n d e n t e  
b u l l e t p o i n t r  
o w y e k l o r t n o c  
a a t u c t r o h s n a  
r i g h t f f o c l s s  
d u p p e r c a s e l e

save	capitals
shortcut	uppercase
indent	lowercase
bullet point	control key
justified	arrow keys
centre	keyboard
left	menu buttons
right	ruler

# Word Processing Skills

d e i f i t s u j d m m  
e r t n e c p t y u e p  
h u c a p i t a l s n t  
m s y e k w o r r a u l  
k a e r u l e r e y b o  
e y t e f t t e l f u w  
y e a t r i n d e n t e  
b u l l e t p o i n t r  
o w y e k l o r t n o c  
a a t u c t r o h s n a  
r i g h t f f o c l s s  
d u p p e r c a s e l e

~~save~~  
~~shortcut~~  
~~indent~~  
~~bullet point~~  
~~justified~~  
~~centre~~  
~~left~~  
~~right~~  
~~capitals~~  
~~uppercase~~  
~~lowercase~~  
~~control key~~  
~~arrow keys~~  
~~keyboard~~  
~~menu buttons~~  
~~ruler~~

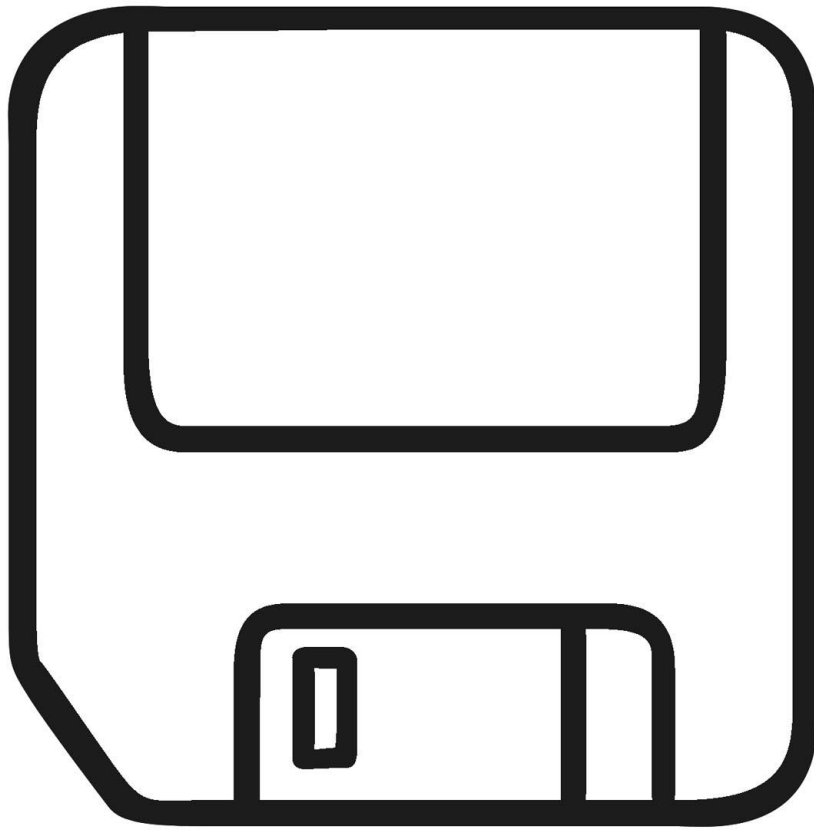





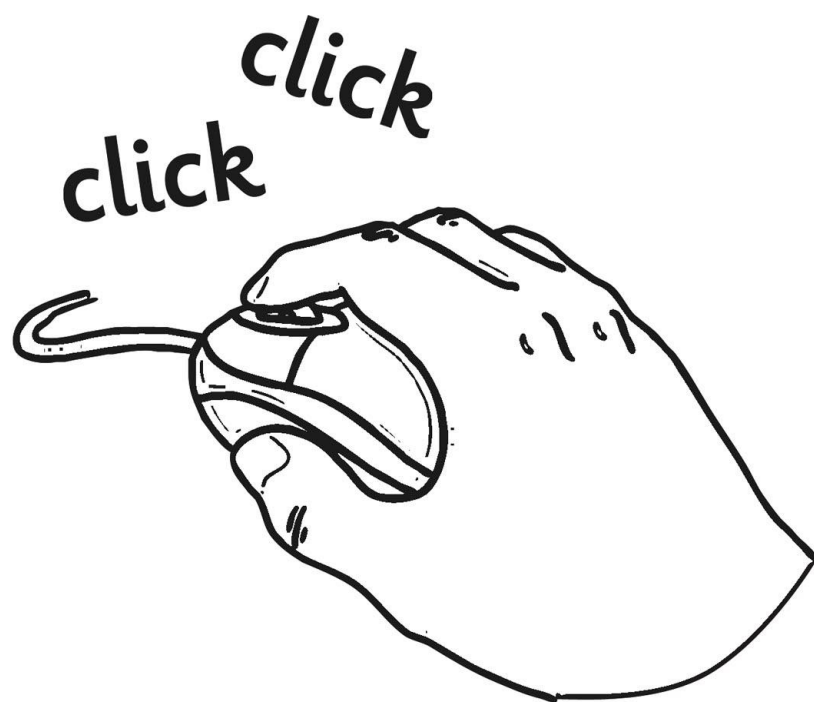



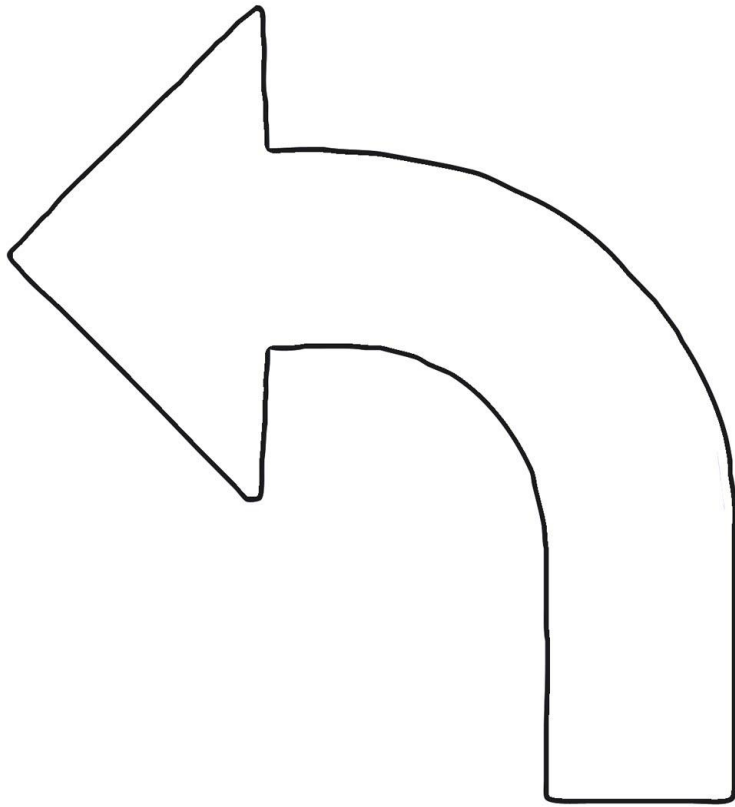

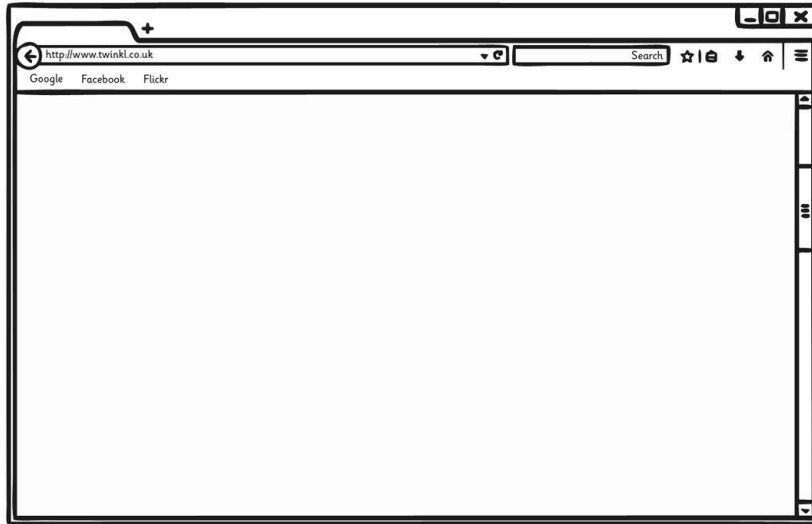

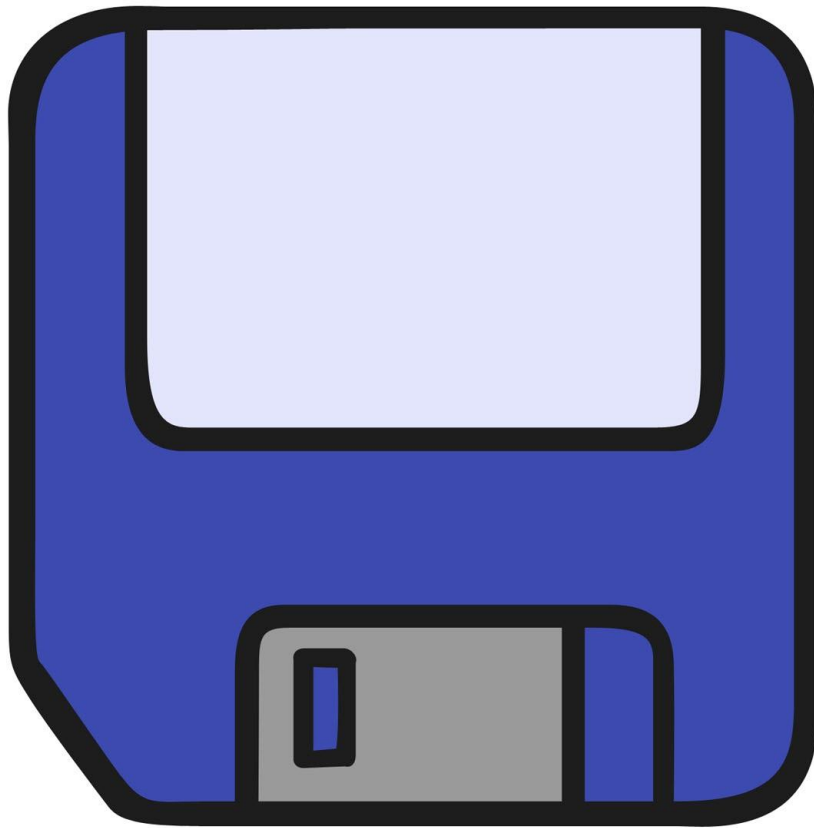

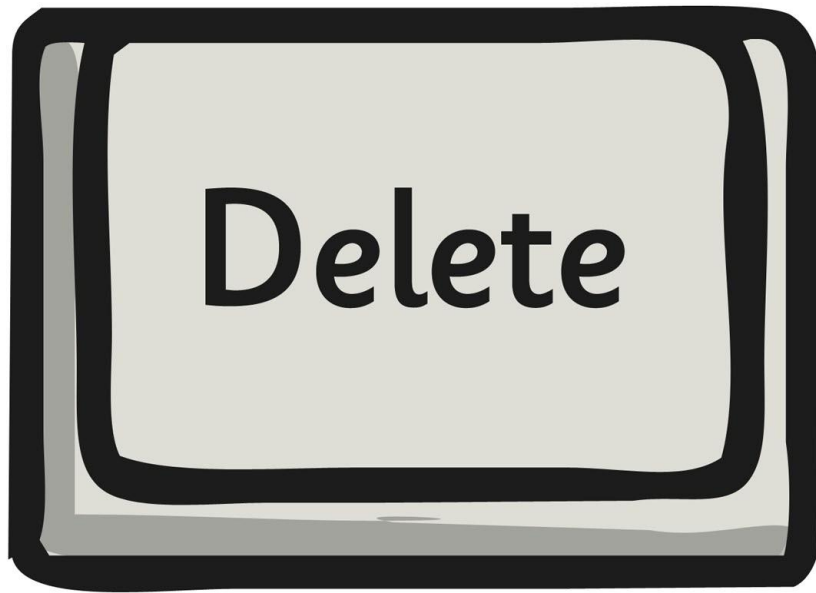

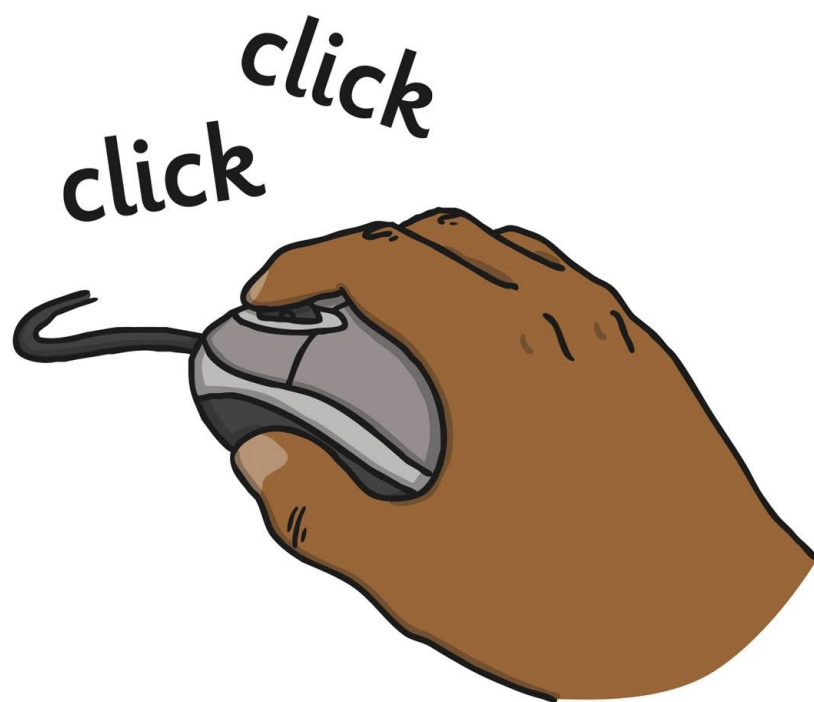





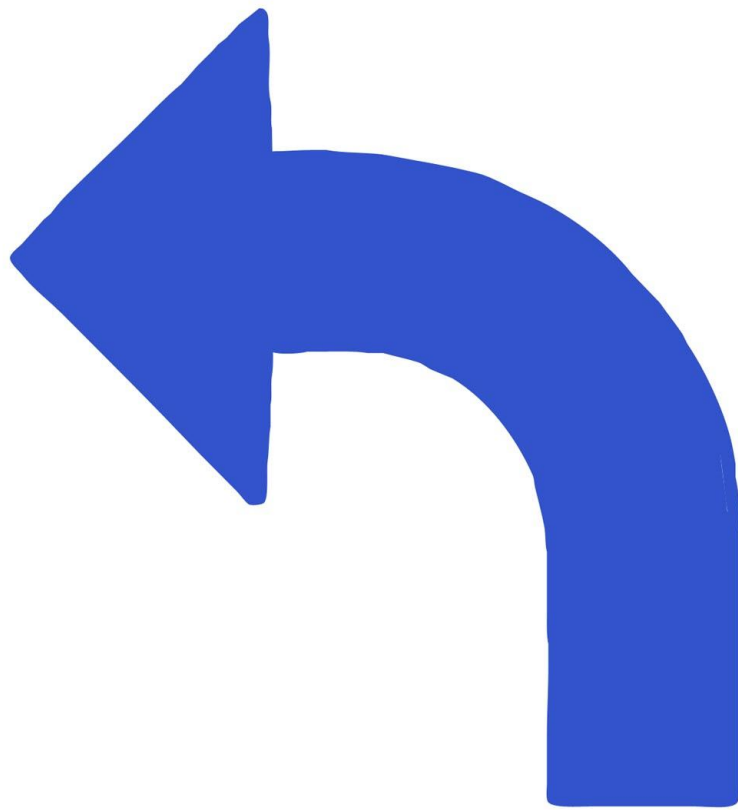

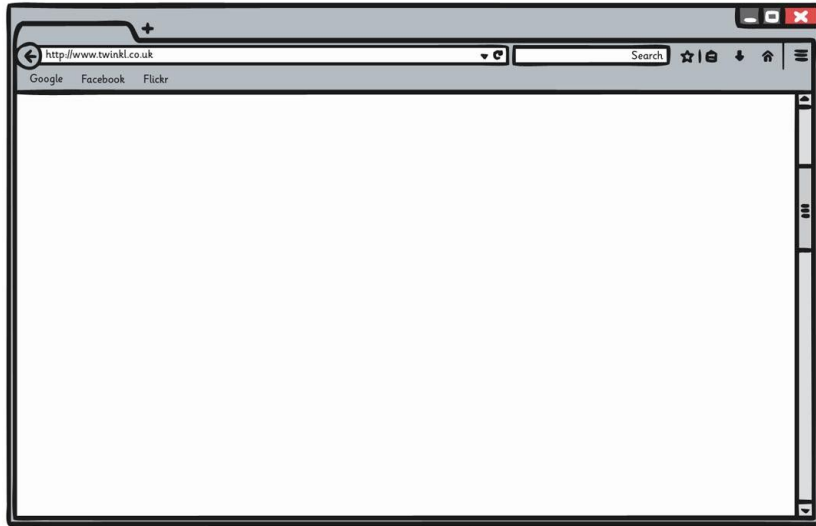

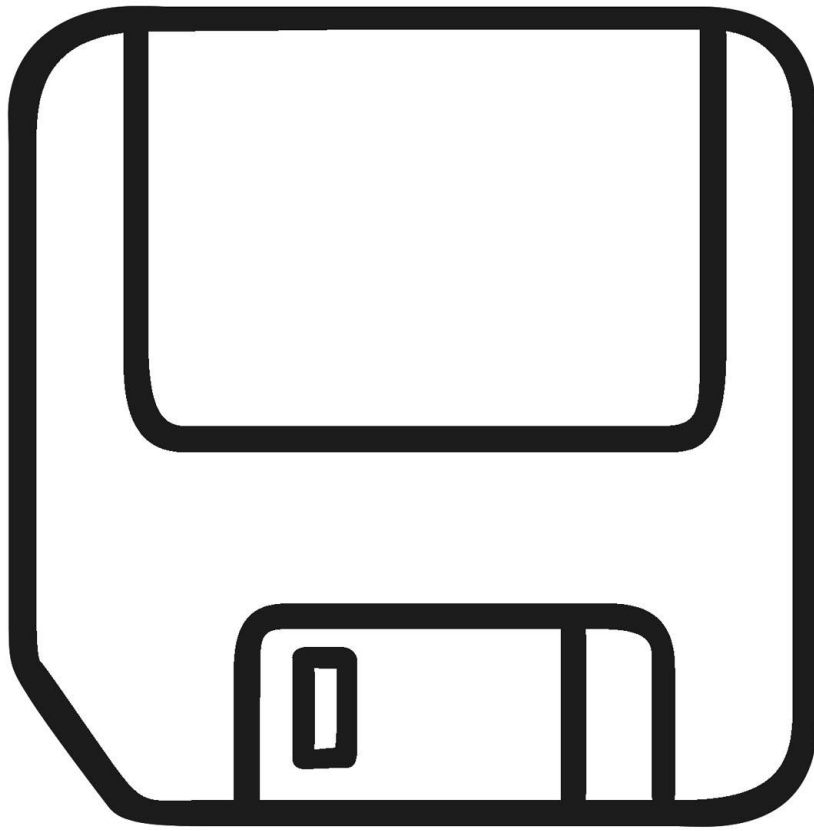

---

---

---

---

---

---

---

---

---

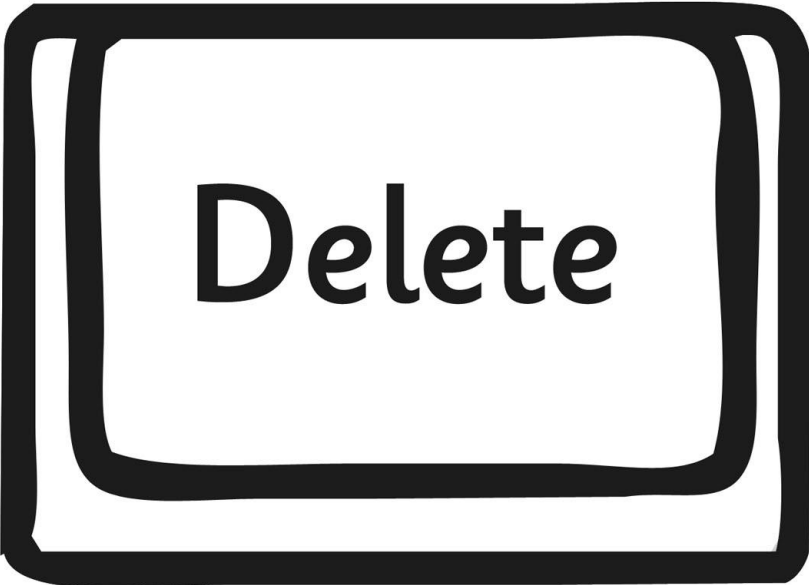

---

---

---

---

---

---

---

---

---

---

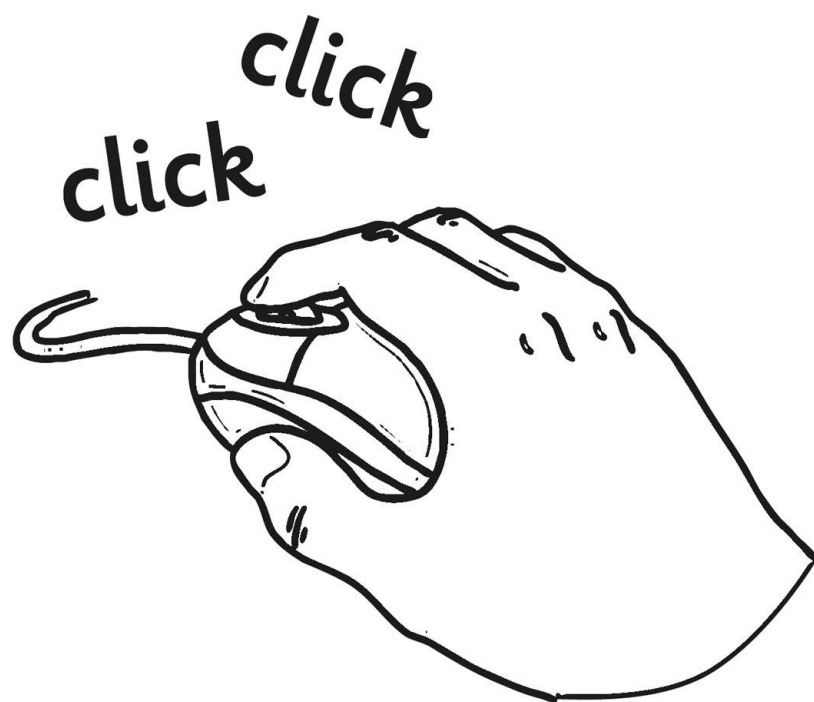

---

---

---

---

---

---

---

---

---



---

---

---

---

---

---

---

---

---

---

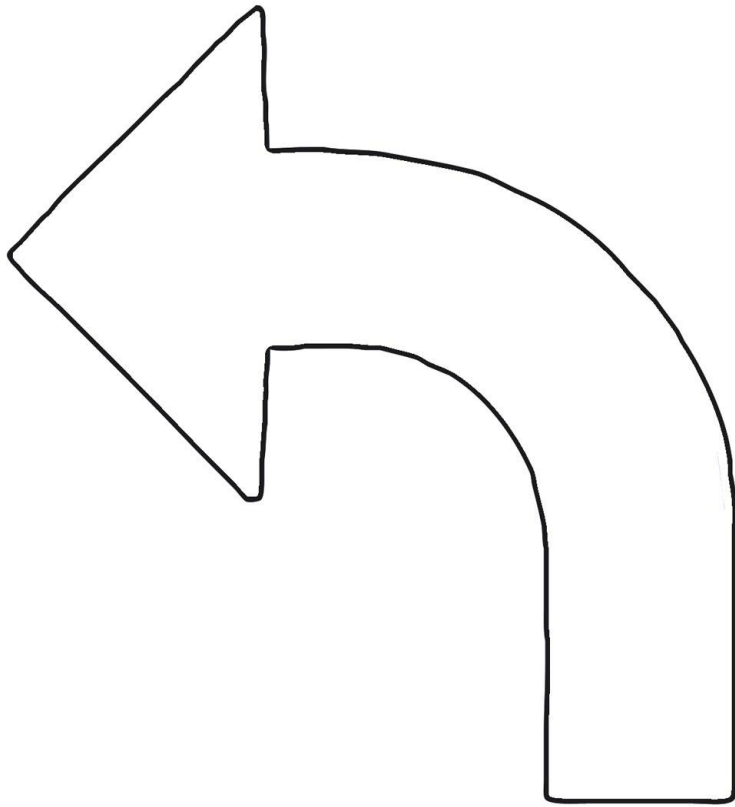



---

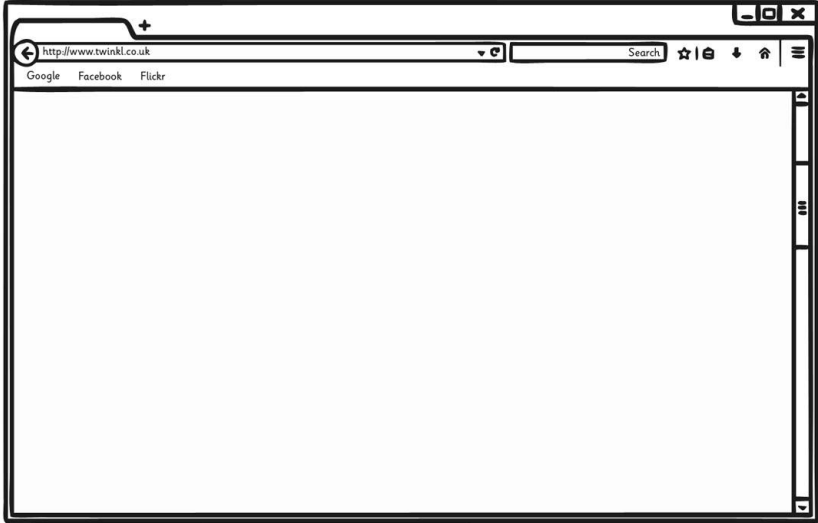

---

---

---

---

---

---

---

---

---

---

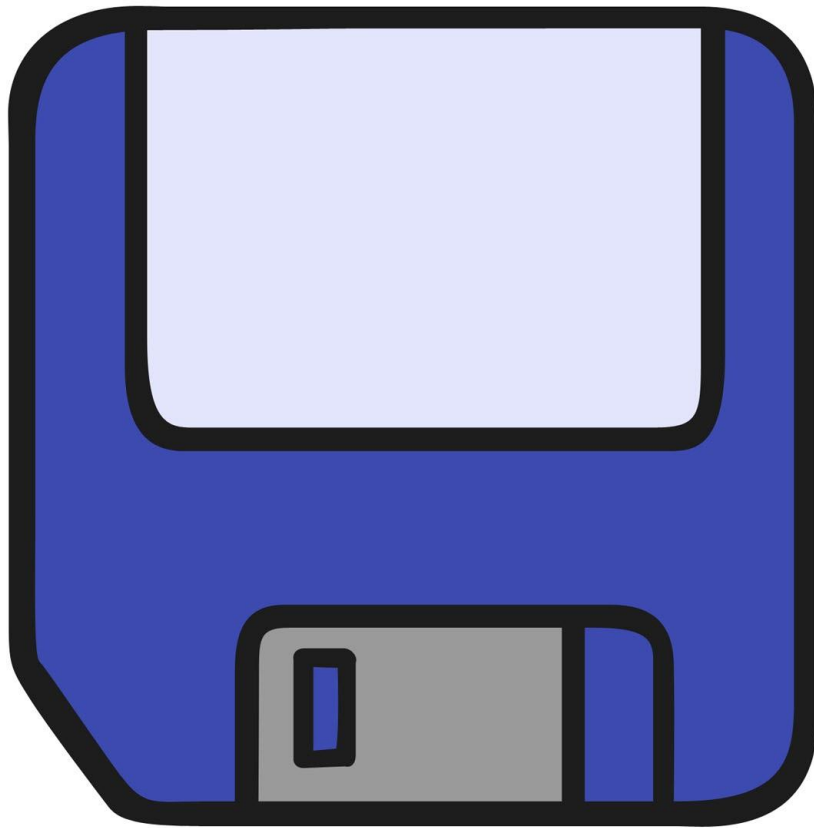

---

---

---

---

---

---

---

---

---

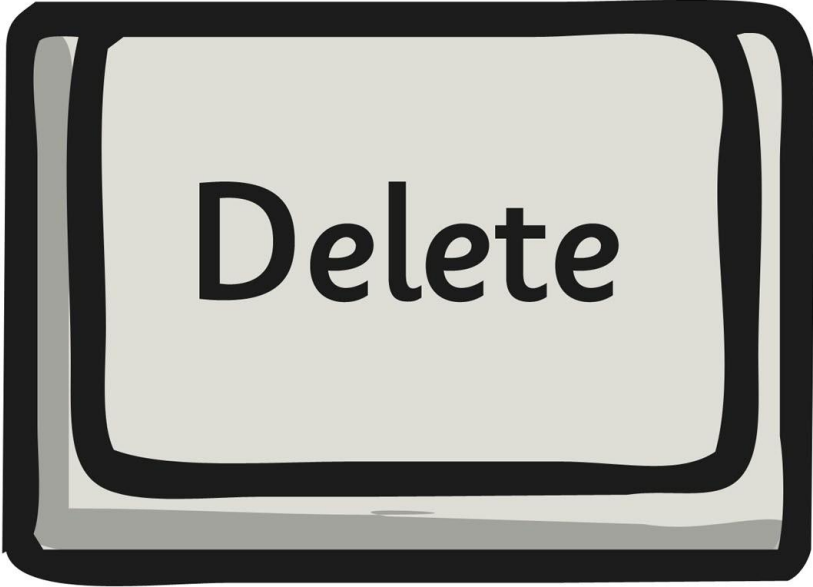

---

---

---

---

---

---

---

---

---

---

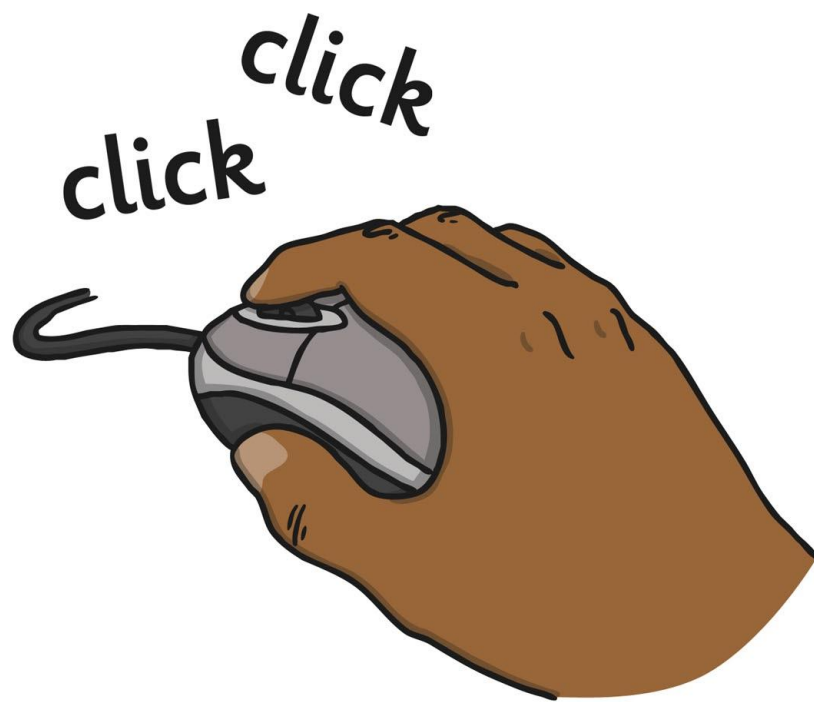

---



---

---

---

---

---

---

---

---

---

---

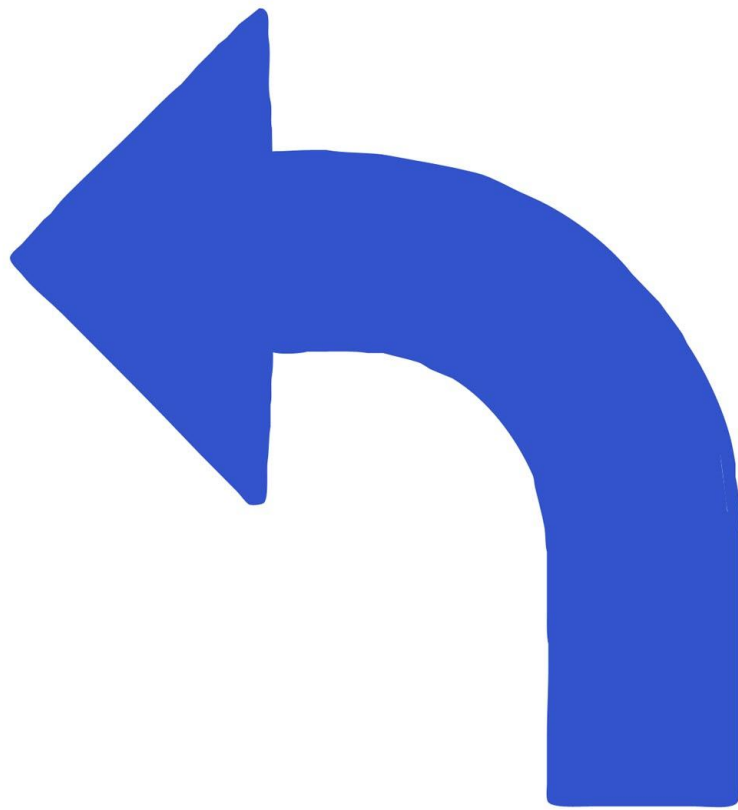

---

---

---

---

---

---

---

---

---

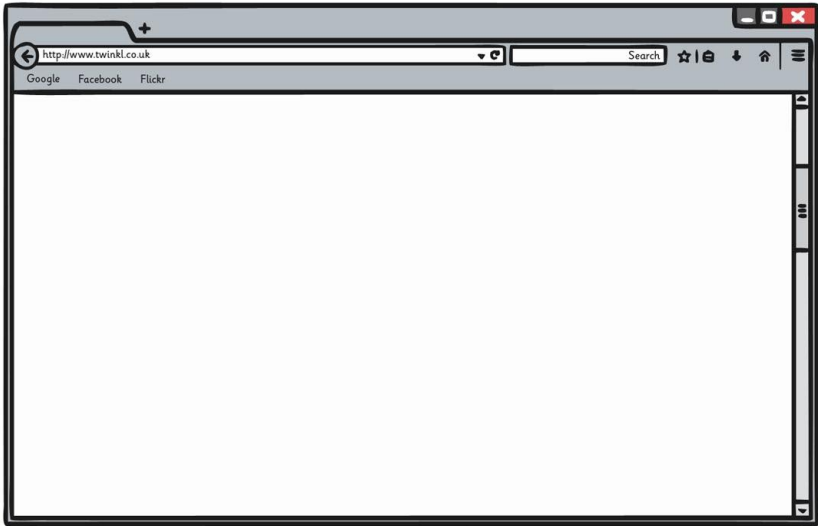

---

---

---

---

---

---

---

---

---

---





\_\_\_\_\_

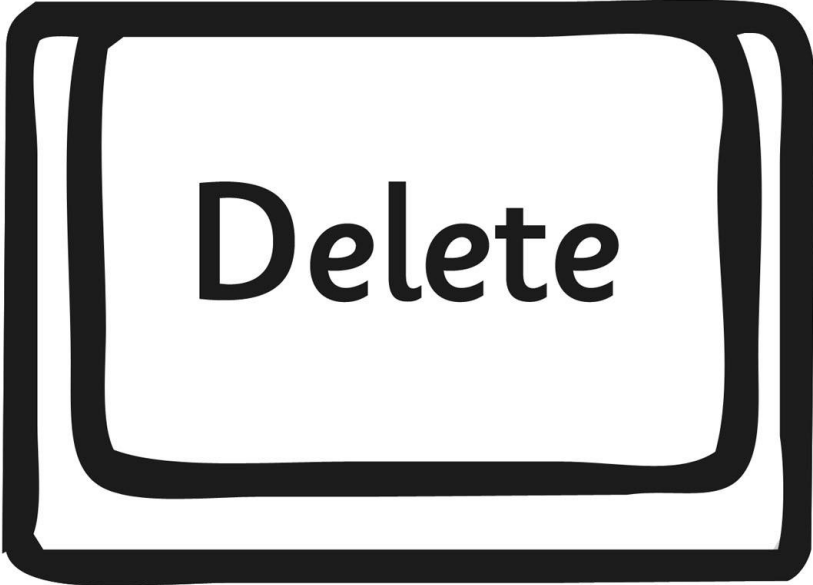

\_\_\_\_\_

\_\_\_\_\_

\_\_\_\_\_

\_\_\_\_\_

\_\_\_\_\_

\_\_\_\_\_

\_\_\_\_\_

\_\_\_\_\_

\_\_\_\_\_

\_\_\_\_\_

\_\_\_\_\_

\_\_\_\_\_

\_\_\_\_\_

\_\_\_\_\_

\_\_\_\_\_

\_\_\_\_\_

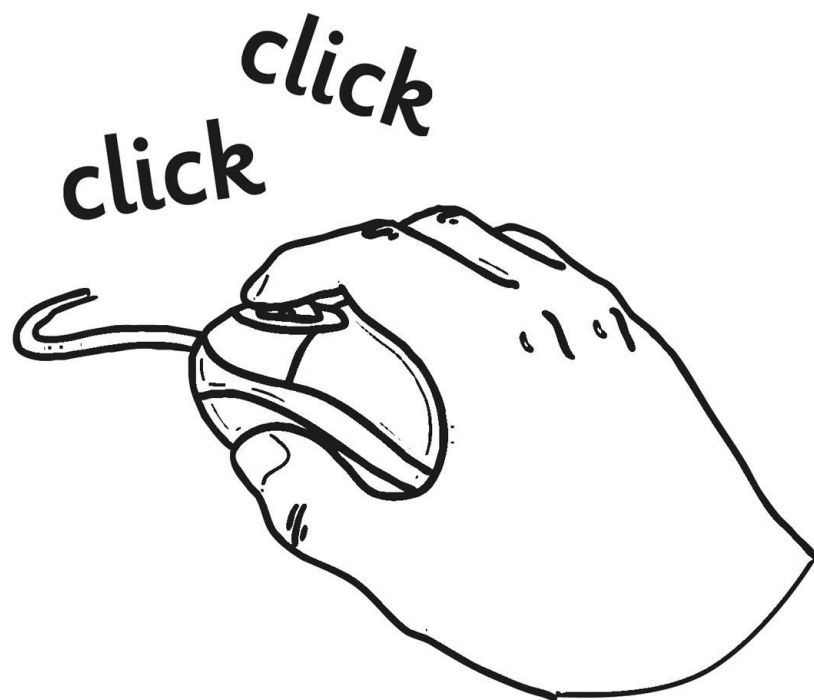

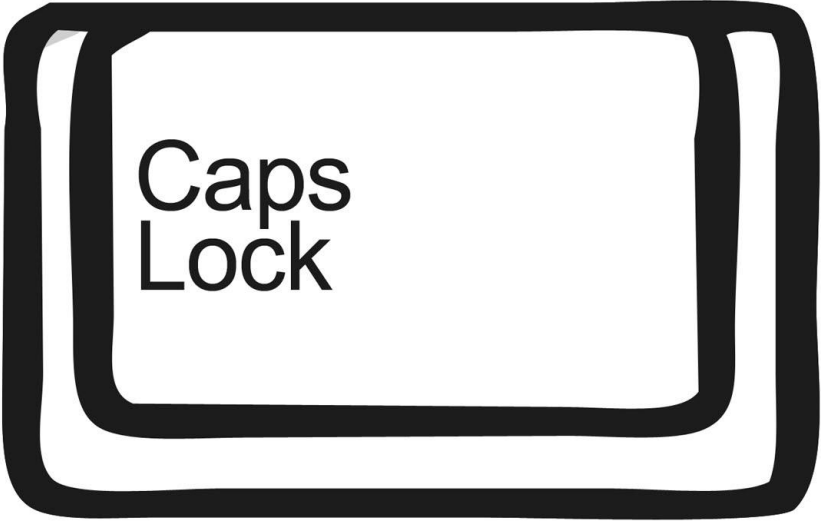

---

---

---

---

---

---

---

---

---

---

---

---

---

---

---

---

---

---

---

---

---

---

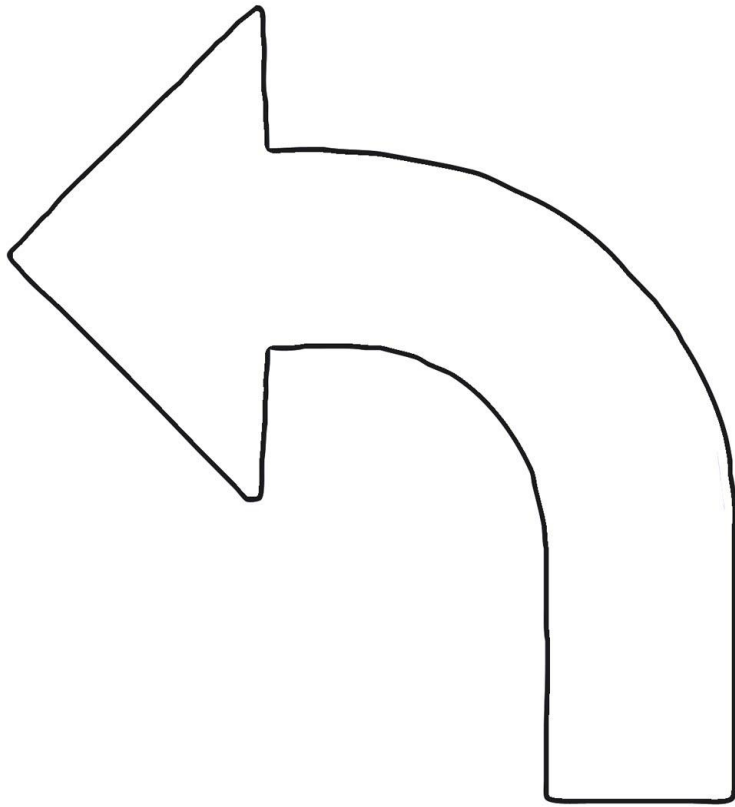

---

---

---

---

---

---

---

---

---

---

---

---

---

---

---

\_\_\_\_\_

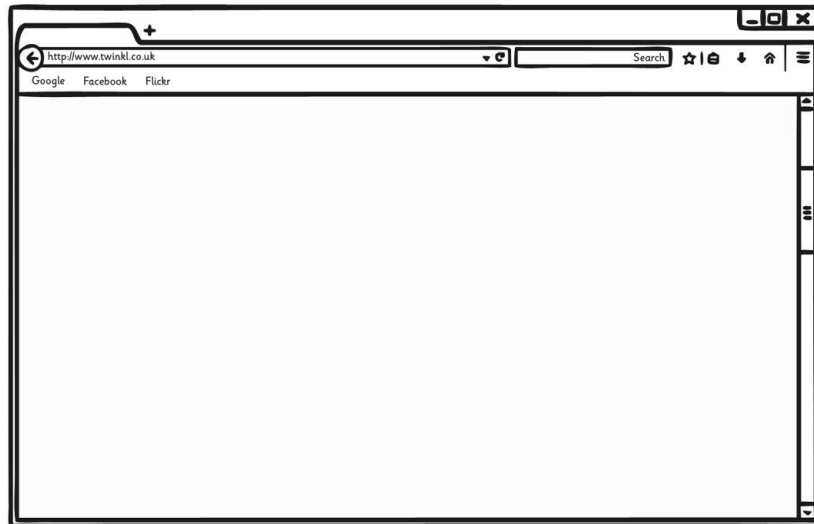

\_\_\_\_\_

\_\_\_\_\_

\_\_\_\_\_

\_\_\_\_\_

\_\_\_\_\_

\_\_\_\_\_

\_\_\_\_\_

\_\_\_\_\_

\_\_\_\_\_

\_\_\_\_\_

\_\_\_\_\_

\_\_\_\_\_

\_\_\_\_\_

\_\_\_\_\_

\_\_\_\_\_

\_\_\_\_\_

\_\_\_\_\_

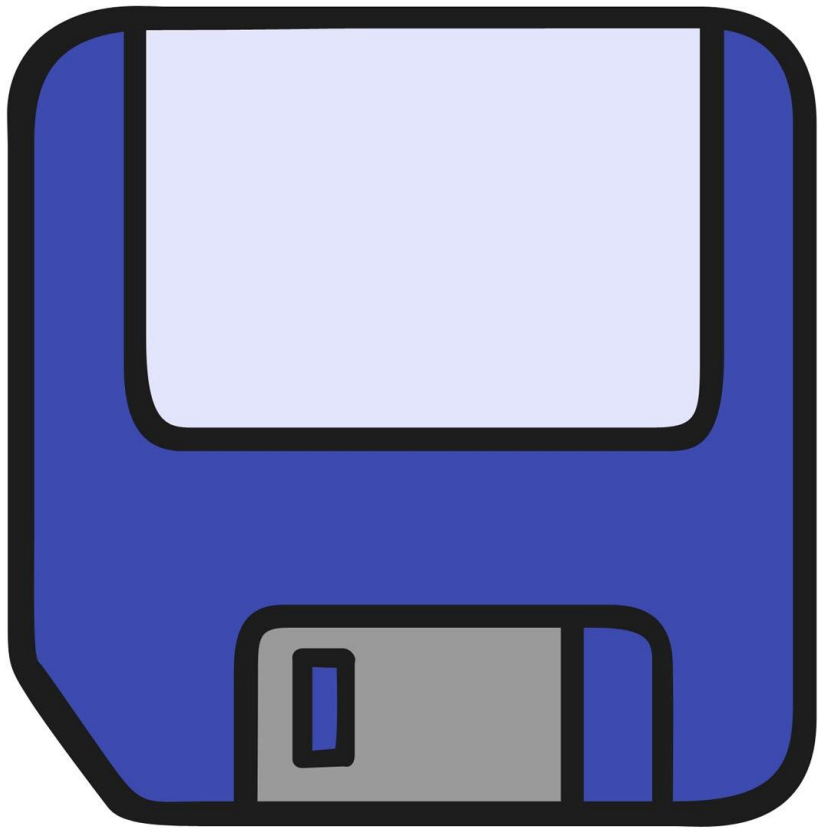

---

---

---

---

---

---

---

---

---

---

---

---

---

---

---

---

---

---

---

---

---

---

---

---

---

---

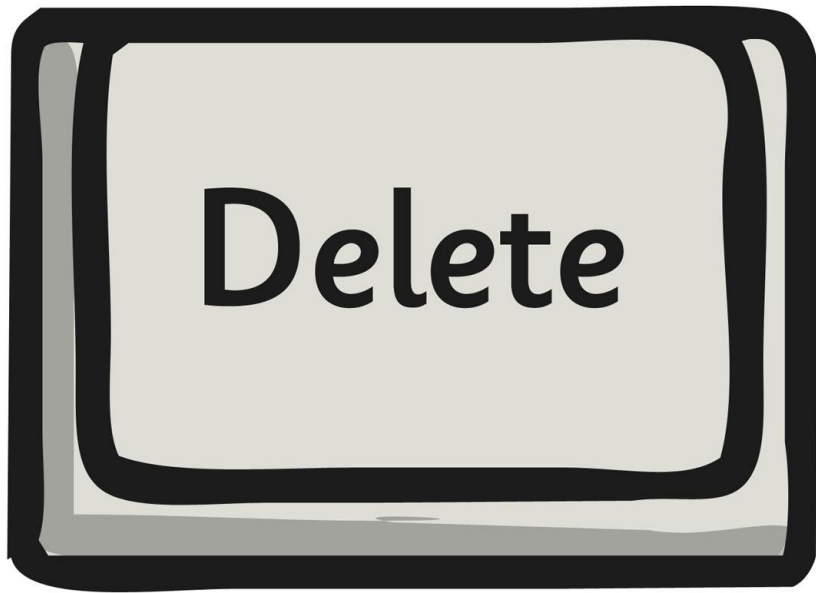

---

---

---

---

---

---

---

---

---

---

---

---

---

---

---

---

---

---

---

---

---

---

---

---

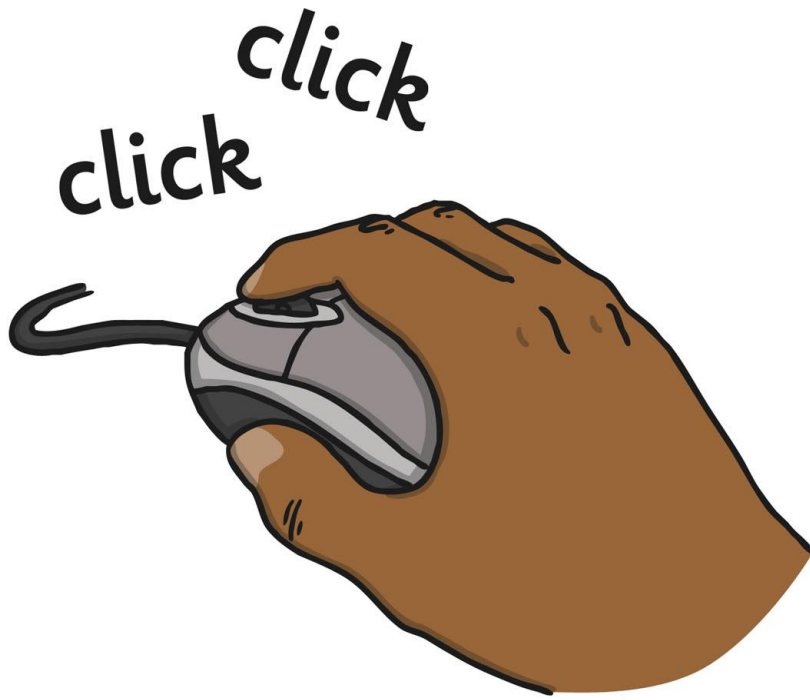



---



---

---

---

---

---

---

---

---

---

---

---

---

---

---

---

---

---

---

---

---

---

---

---

---

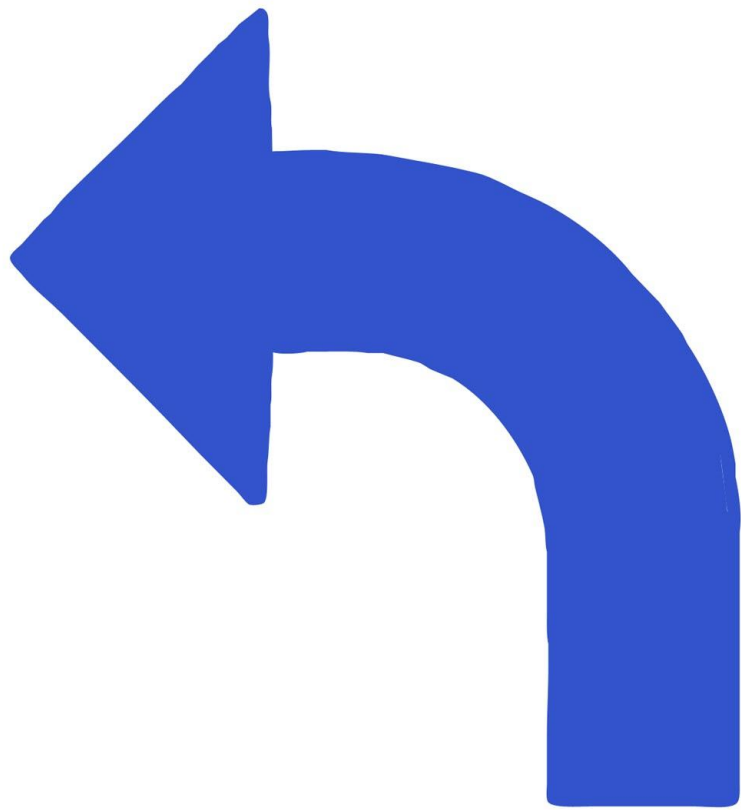

---

---

---

---

---

---

---

---

---

---

---

---

---

---

---

---

---

---

---

---

---

---

---

---

---

---

---

---

---

---



Insert Text Here

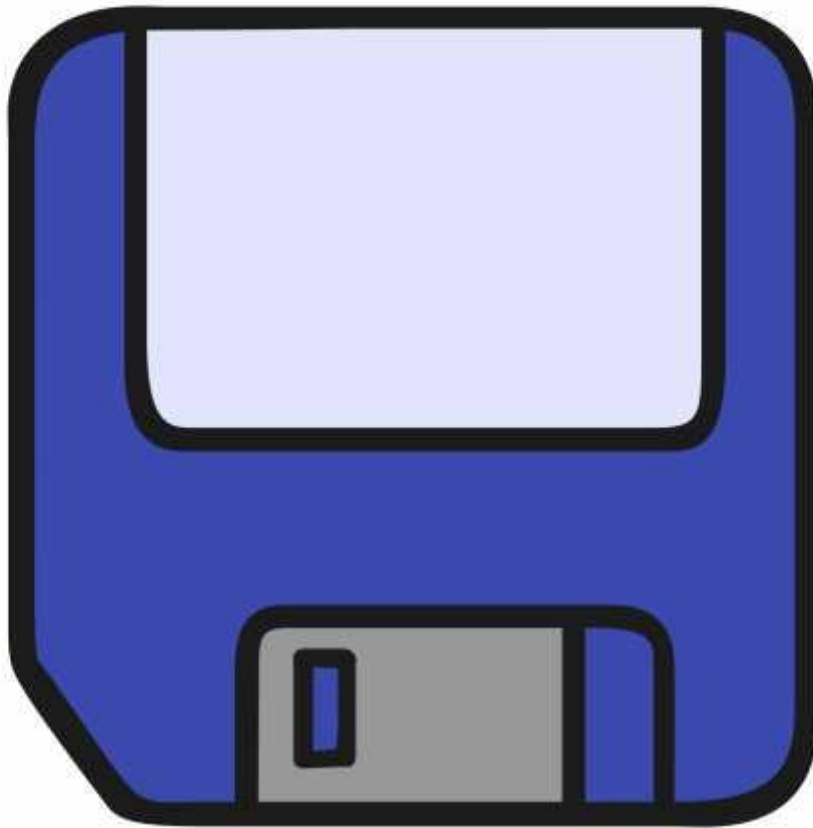

Insert Text Here

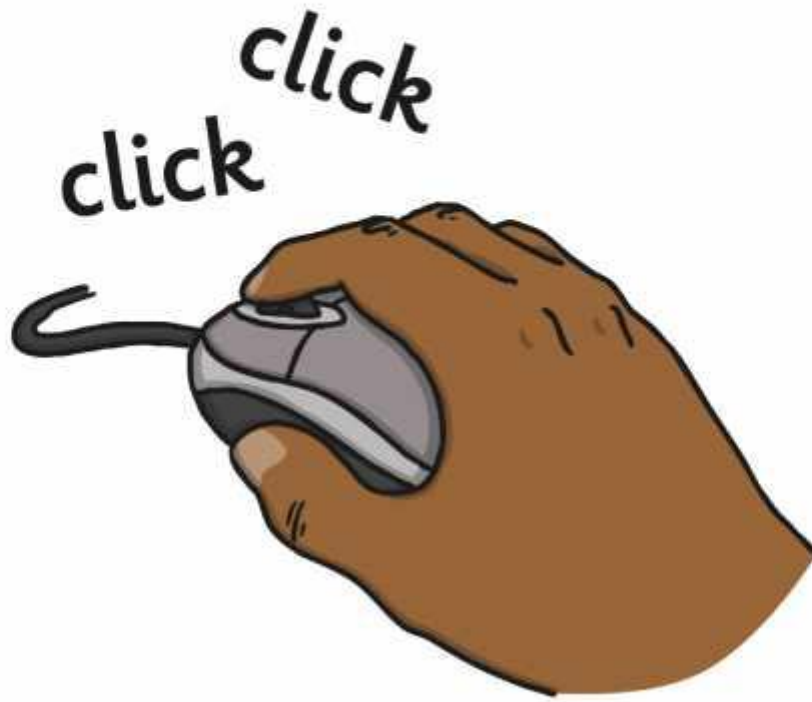

Insert Text Here



Insert Text Here



Insert Text Here

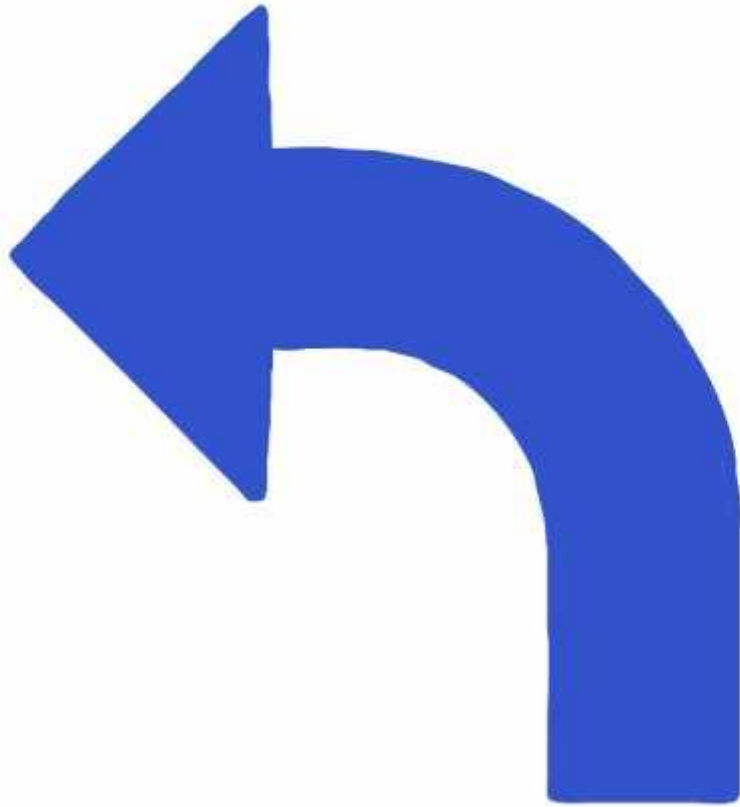



Insert Text Here

